

Analog Input Module (RTD, TC)

RIO3-RTD / RIO3-TC User Manual

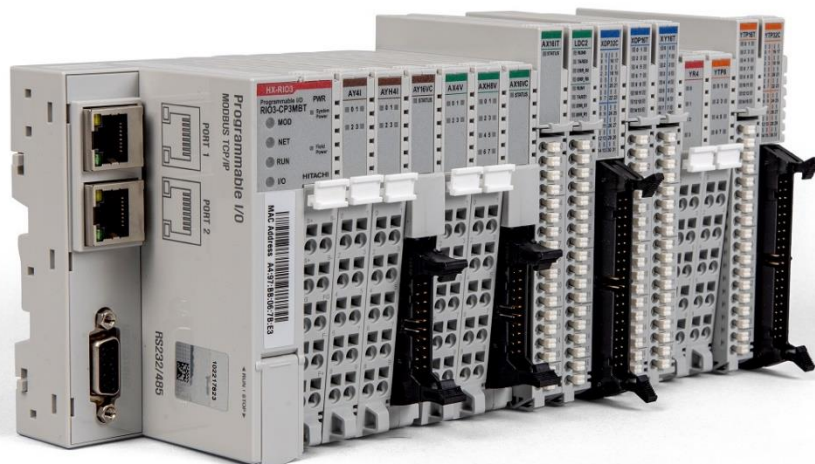

REVISION HISTORY				
REV	PAGE	REMARKS	DATE	EDITOR
1.01		New Document	05 NOV 2020	(OPR), (PF)

Table of Contents

1	Important Notes	4
1.1	Safety Instruction	5
1.1.1	Symbols	5
1.1.2	Safety Notes	5
1.1.3	Certification	5
2	Analog Input Module List	6
3	Specification	7
3.1	RIO3-RTD4T	7
3.1.1	Wiring Diagram	7
3.1.2	LED Indicator	8
3.1.3	Channel Status LED	8
3.1.4	Environment Specification	9
3.1.5	Specification.....	10
3.1.6	Mapping Data into the Image Table.....	11
3.1.7	Configuration Parameter – 10 Bytes	12
3.1.8	Data Value	13
3.2	RIO3-RTD8C	14
3.2.1	Wiring Diagram	14
3.2.2	LED Indicator	15
3.2.3	Channel Status LED	15
3.2.4	Environment Specification	16
3.2.5	Specification.....	17
3.2.6	Mapping Data into the Image Table.....	18
3.2.7	Configuration Parameter – 18 Bytes	19
3.2.8	Data Value	20
3.3	RIO3-TC4T	21
3.3.1	Wiring Diagram	21
3.3.2	LED Indicator	22
3.3.3	Channel Status LED	22
3.3.4	Environment Specification	23
3.3.5	Specification.....	24
3.3.6	Mapping Data into the Image Table.....	26
3.3.7	Configuration Parameter – 8 Bytes	27
3.3.8	Data Value	28
4	Dimension	29
4.1	10-Pts. Spring Type	29
4.2	20-Pin Connector Type.....	30
5	Mounting	31
5.1	I/O Inserting and Removing Devices	31
5.2	RTB (Removable Terminal Block)	32
6	G-Bus Pin Description	33
7	APPENDIX.....	34
7.1	Product List.....	34
7.2	Glossary.....	35

1 Important Notes

Solid state equipment has operational characteristics differing from those of electromechanical equipment.

Safety Guidelines for the Application, Installation and Maintenance of Solid-State Controls describes some important differences between solid state equipment and hard-wired electromechanical devices.

Because of this difference, and because of the wide variety of uses for solid state equipment, all persons responsible for applying this equipment must satisfy themselves that each intended application of this equipment is acceptable.

In no event will HITACHI be responsible or liable for indirect or consequential damages resulting from the use or application of this equipment.

The examples and diagrams in this manual are included solely for illustrative purposes. Because of the many variables and requirements associated with any installation, HITACHI cannot assume responsibility or liability for actual use based on the examples and diagrams.

Warning!



- ✓ **If you don't follow the directions, it could cause a personal injury, damage to the equipment or explosion**
- ✓ Do not assemble the products and wire with power applied to the system. Else it may cause an electric arc, which can result into unexpected and potentially dangerous action by field devices. Arching is explosion risk in hazardous locations. Be sure that the area is non-hazardous or remove system power appropriately before assembling or wiring the modules.
- ✓ Do not touch any terminal blocks or IO modules when system is running. Else it may cause the unit to an electric shock or malfunction.
- ✓ Keep away from the strange metallic materials not related to the unit and wiring works should be controlled by the electric expert engineer. Else it may cause the unit to a fire, electric shock or malfunction.

Caution!

- ✓ **If you disobey the instructions, there may be possibility of personal injury, damage to equipment or explosion. Please follow below Instructions.**
- ✓ Check the rated voltage and terminal array before wiring. Avoid the circumstances over 50°C of temperature. Avoid placing it directly in the sunlight.
- ✓ Avoid the place under circumstances over 85% of humidity.
- ✓ Do not place Modules near by the inflammable material. Else it may cause a fire.
- ✓ Do not permit any vibration approaching it directly.
- ✓ Go through module specification carefully, ensure inputs, output connections are made with the specifications. Use standard cables for wiring.
- ✓ Use Product under pollution degree 2 environment.

1.1 Safety Instruction

1.1.1 Symbols

<p>DANGER</p> 	<p>Identifies information about practices or circumstances that can cause an explosion in a hazardous environment, which may lead to personal injury or death property damage, or economic loss</p>
<p>IMPORTANT</p>	<p>Identifies information that is critical for successful application and understanding of the product.</p>
<p>ATTENTION</p> 	<p>Identifies information about practices or circumstances that can lead to personal injury, property damage, or economic loss.</p> <p>Attentions help you to identify a hazard, avoid a hazard, and recognize the Consequences.</p>

1.1.2 Safety Notes

<p>DANGER</p> 	<p>The modules are equipped with electronic components that may be destroyed by electrostatic discharge. When handling the modules, ensure that the environment (persons, workplace and packing) is well grounded. Avoid touching conductive components, G-BUS Pin.</p>
--	---

1.1.3 Certification

UL Listed Industrial Control Equipment, certified for U.S.

See UL File E196687

CE Certificate

EN 61000-6-2; Industrial Immunity

EN 61000-6-4; Industrial Emissions

Reach, RoHS (EU, CHINA), EAC

2 Analog Input Module List

RIO3-Number	Description	ID (hex)
RIO3-RTD4T	Analog Input 4 Channels, RTD / Resistance Input, 10 RTB	3704
RIO3-RTD8C	Analog Input 8 Channels, RTD / Resistance Input, 20P Connector	3708
RIO3-TC4T	Analog Input 4 Channels, Thermocouple / mV Input, 10 RTB	3804

3 Specification

3.1 RIO3-RTD4T

3.1.1 Wiring Diagram

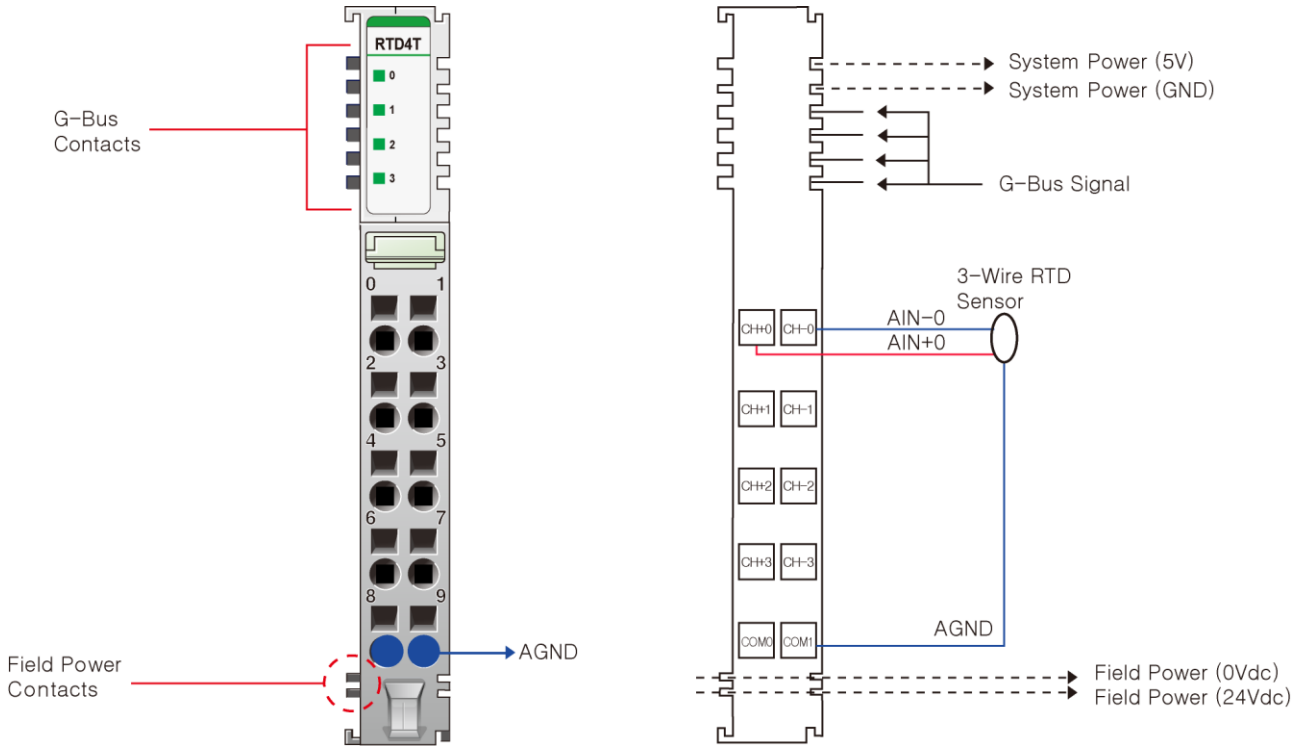

Pin No.	Signal Description	Signal Description	Pin No.
0	RTD Channel 0+	RTD Channel 0-	1
2	RTD Channel 1+	RTD Channel 1-	3
4	RTD Channel 2+	RTD Channel 2-	5
6	RTD Channel 3+	RTD Channel 3-	7
8	AGND	AGND	9

3.1.2 LED Indicator

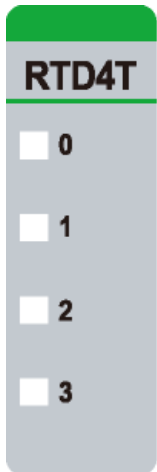

LED No.	LED Function / Description	LED Color
0	Input Channel 0	Green
1	Input Channel 1	Green
2	Input Channel 2	Green
3	Input Channel 3	Green

3.1.3 Channel Status LED

Status	LED	To indicate
No Signal	Off	Input Sensor Open or Input Range Over
Normal Operation		Normal Operation
On Signal	Green	Sensor Connected and Input Range Valid
Normal Operation		Normal Operation

3.1.4 Environment Specification

Environmental Specification	
Operation Temperature	-40°C ~ 70°C
UL Temperature	-20°C ~ 60°C
Storage Temperature	-40°C ~ 85°C
Relative Humidity	5% ~ 90% Non-condensing
Operating Altitude	2,000m
Mounting	DIN Rail
General Specification	
Shock Operating	IEC 60068-2-27: 2008/ 15g, 11bs
Vibration Resistance	Based on IEC 60068-2-6 DNVGL-CG-0039: 2016/ Vibration Class B, 4g
Industrial Emissions	EN 61000-6-4: 2007 + A1: 2011
Industrial Immunity	EN 61000-6-2: 2005
Protection Class	Variable / IP20
Installation Position	Vertical and horizontal installation is possible.
Product Certifications	CE, UL, EAC

3.1.5 Specification

Items																													
Input Specification																													
Inputs Per Module	4 Channels																												
Indicators	4 Green Input Status LEDs																												
Sensor Types	RTD Input Range																												
	<table border="1"> <thead> <tr> <th>RTD Input</th> <th>Input Range</th> </tr> </thead> <tbody> <tr> <td>PT100, PT200, PT500, PT50</td> <td>-200~850°C</td> </tr> <tr> <td>PT1000</td> <td>-200~350°C</td> </tr> <tr> <td>JPT100, JPT200, JPT500, JPT50</td> <td>-200~640°C</td> </tr> <tr> <td>JPT1000</td> <td>-200~350°C</td> </tr> <tr> <td>NI100, NI200, NI500</td> <td>-60~250°C</td> </tr> <tr> <td>NI1000</td> <td>-60~180°C</td> </tr> <tr> <td>NI120</td> <td>-80~260°C</td> </tr> <tr> <td>NI1000LG</td> <td>-50~120°C</td> </tr> <tr> <th>Resistance Input</th> <th>Input Range</th> </tr> <tr> <td>100mΩ/Bit</td> <td>0~2000Ω</td> </tr> <tr> <td>10mΩ/Bit</td> <td>0~327Ω</td> </tr> <tr> <td>20mΩ/Bit</td> <td>0~620Ω</td> </tr> <tr> <td>50mΩ/Bit</td> <td>0~1200Ω</td> </tr> </tbody> </table>	RTD Input	Input Range	PT100, PT200, PT500, PT50	-200~850°C	PT1000	-200~350°C	JPT100, JPT200, JPT500, JPT50	-200~640°C	JPT1000	-200~350°C	NI100, NI200, NI500	-60~250°C	NI1000	-60~180°C	NI120	-80~260°C	NI1000LG	-50~120°C	Resistance Input	Input Range	100mΩ/Bit	0~2000Ω	10mΩ/Bit	0~327Ω	20mΩ/Bit	0~620Ω	50mΩ/Bit	0~1200Ω
	RTD Input	Input Range																											
	PT100, PT200, PT500, PT50	-200~850°C																											
	PT1000	-200~350°C																											
	JPT100, JPT200, JPT500, JPT50	-200~640°C																											
	JPT1000	-200~350°C																											
	NI100, NI200, NI500	-60~250°C																											
	NI1000	-60~180°C																											
	NI120	-80~260°C																											
	NI1000LG	-50~120°C																											
	Resistance Input	Input Range																											
	100mΩ/Bit	0~2000Ω																											
	10mΩ/Bit	0~327Ω																											
20mΩ/Bit	0~620Ω																												
50mΩ/Bit	0~1200Ω																												
Excitation Current	About 1mA																												
Connection Method	3-Wire																												
Conversion Time	< 150ms, All Channel																												
Data Format	16 Bits signed Integer (2' complement)																												
Module Accuracy	PT100, PT1000 Type Input Range - 0.5°C Full Scale @ 25°C ambient All Type Input Range - ±0.1% Full Scale @ 25°C ambient - ±0.3% Full Scale @ -40 ~ 70°C ambient																												
Resolution of Data	RTD Type: ±0.1°C / F, Resistance Type: 100mΩ, 10mΩ, 20mΩ, 50mΩ																												
Calibration	Not Required																												
Diagnostic	Sensor open or range over, then conversion data = 0x8000 (-32768)																												
General Specification																													
Power Dissipation	Max. 130mA @ 5Vdc																												
Isolation	I/O to Logic: Photocoupler Isolation Field power: Not Connected																												

UL Filed Power	Supply voltage: 24Vdc nominal, Class 2
Field Power	Not used, Field Power passes through to the next module
Wiring	I/O Cable Max. 2.0mm ² (AWG 14)
Torque	0.8Nm (7lb-in)
Weight	60g
Module Size	12mm x 99mm x 70mm
Environment Condition	Refer to 'Environment Specification'

3.1.6 Mapping Data into the Image Table

Input Module Data

Analog Input Ch0
Analog Input Ch1
Analog Input Ch2
Analog Input Ch3

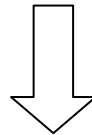

Input Image Value

Bit No	Bit7	Bit6	Bit5	Bit4	Bit3	Bit2	Bit1	Bit0
Byte 0	Analog Input Ch0 Low byte							
Byte 1	Analog Input Ch0 High byte							
Byte 2	Analog Input Ch1 Low byte							
Byte 3	Analog Input Ch1 High byte							
Byte 4	Analog Input Ch2 Low byte							
Byte 5	Analog Input Ch2 High byte							
Byte 6	Analog Input Ch3 Low byte							
Byte 7	Analog Input Ch3 High byte							

If the input of channel is open or over-ranged, its conversion data will be 0x8000 (-32678)

3.1.7 Configuration Parameter – 10 Bytes

Byte	Decimal Bit	Description	Default Value
0	00-07	The selection Sensor Type =00h: PT100, 0.00385, -200~850°C, 0.1°C/count =01h: PT200, 0.00385, -200~850°C, 0.1°C/count =02h: PT500, 0.00385, -200~850°C, 0.1°C/count =03h: PT1000, 0.00385, -200~350°C, 0.1°C/count =04h: PT50, 0.00385, -200~850°C, 0.1°C/count =10h: JPT100, 0.003916, -200~640°C, 0.1°C/count =11h: JPT200, 0.003916, -200~640°C, 0.1°C/count =12h: JPT500, 0.003916, -200~640°C, 0.1°C/count =13h: JPT1000, 0.003916, -200~350°C, 0.1°C/count =14h: JPT50, 0.003916, -200~640°C, 0.1°C/count =20h: NI100, 0.00618, -60~250°C, 0.1°C/count =21h: NI200, 0.00618, -60~250°C, 0.1°C/count =22h: NI500, 0.00618, -60~250°C, 0.1°C/count =23h: NI1000, 0.00618, -60~180°C, 0.1°C/count =30h: NI120, 0.00672, -80~250°C, 0.1°C/count =53h: NI1000LG, 0.00500, -50~120°C, 0.1°C/count =80h: Resistance Input, 1~2000Ω, 100mΩ / 1 count =81h: Resistance Input, 1~327Ω, 10mΩ / 1 count =82h: Resistance Input, 1~620Ω, 20mΩ / 1 count =83h: Resistance Input, 1~1200Ω, 50mΩ / 1 count =Others: Reserved	0: PT100
1	00	Temperature Type 0: Celsius(°C), 1: Fahrenheit(°F)	0: Celsius(°C)
	01	Reserved	0
	02	Data Resolution 0: 0.1°C, °F / Bit, 1: 1°C, °F / Bit	0
	03	Reserved	0
	04	Filter Type 0: Normal Filter, 1: Enhanced Filter	0: Normal Filter
	05-07	Reserved	0
2~3	-	CH0 Offset Value	0
4~5	-	CH1 Offset Value	0
6~7	-	CH2 Offset Value	0
8~9	-	CH3 Offset Value	0

3.1.8 Data Value

Resistance Temperature Detector Input Range	
Type	Input Range
PT100	-200 ~ 850 °C
PT200	-200 ~ 850 °C
PT500	-200 ~ 850 °C
PT1000	-200 ~ 350 °C
PT50	-200 ~ 850 °C
JPT100	-200 ~ 640 °C
JPT200	-200 ~ 640 °C
JPT500	-200 ~ 640 °C
JPT1000	-200 ~ 350 °C
JPT50	-200 ~ 640 °C
NI100	-60 ~ 250 °C
NI200	-60 ~ 250 °C
NI500	-60 ~ 250 °C
NI1000	-60 ~ 180 °C
NI120	-80 ~ 260 °C
NI1000LG	-50 ~ 120 °C
Resistance Input Range	
Type	Input Range
100mΩ/Bit	0 ~ 2000 Ω
10mΩ/Bit	0 ~ 327 Ω
20mΩ/Bit	0 ~ 620 Ω
50mΩ/Bit	0 ~ 1200 Ω

3.2 RIO3-RTD8C

3.2.1 Wiring Diagram

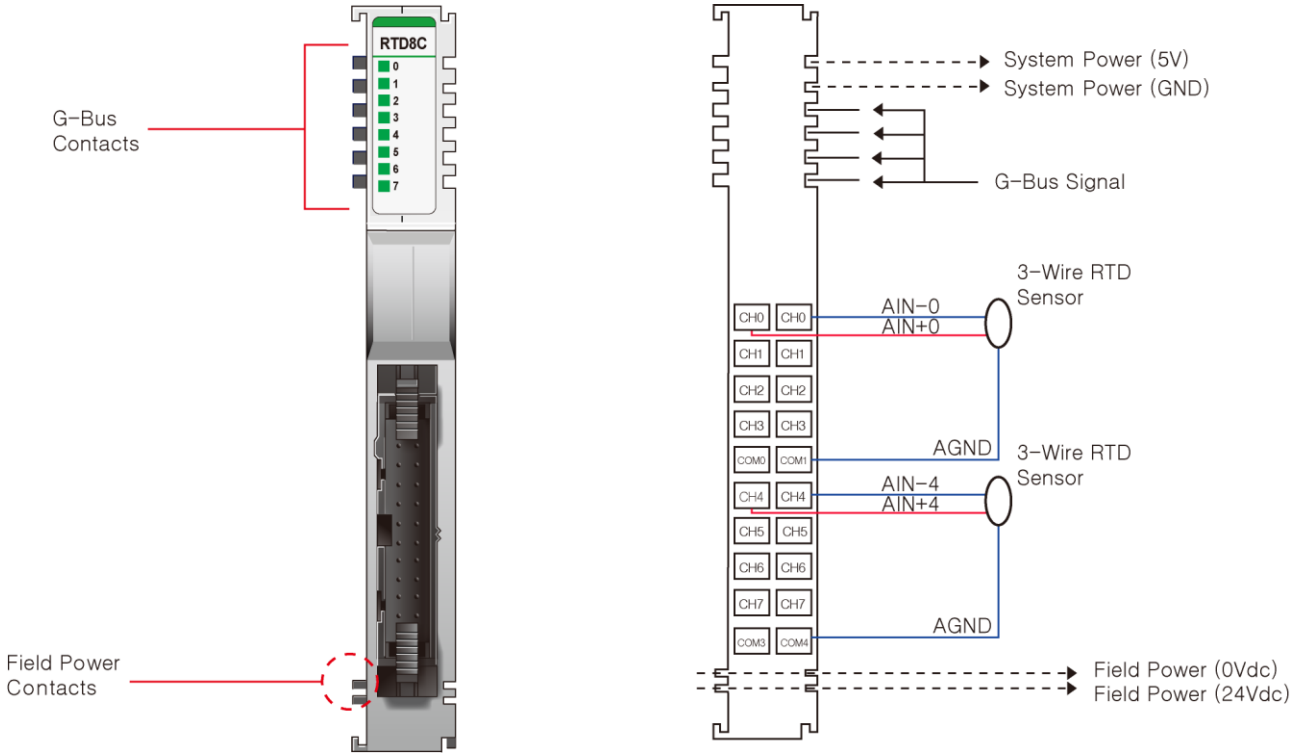

Pin No.	Signal Description	Signal Description	Pin No.
0	RTD Channel 0+	RTD Channel 0-	1
2	RTD Channel 1+	RTD Channel 1-	3
4	RTD Channel 2+	RTD Channel 2-	5
6	RTD Channel 3+	RTD Channel 3-	7
8	AGND	AGND	9
10	RTD Channel 4+	RTD Channel 4-	11
12	RTD Channel 5+	RTD Channel 5-	13
14	RTD Channel 6+	RTD Channel 6-	15
16	RTD Channel 7+	RTD Channel 7-	17
18	AGND	AGND	19

3.2.2 LED Indicator

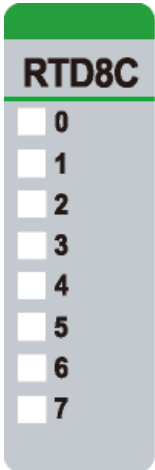

LED No.	LED Function / Description	LED Color
0	Input Channel 0	Green
1	Input Channel 1	Green
2	Input Channel 2	Green
3	Input Channel 3	Green
4	Input Channel 4	Green
5	Input Channel 5	Green
6	Input Channel 6	Green
7	Input Channel 7	Green

3.2.3 Channel Status LED

Status	LED	To indicate
No Signal	Off	Input Sensor Open or Input Range Over
Normal Operation		Normal Operation
On Signal	Green	Sensor Connected and Input Range Valid
Normal Operation		Normal Operation

3.2.4 Environment Specification

Environmental Specification	
Operation Temperature	-40°C ~ 70°C
UL Temperature	-20°C ~ 60°C
Storage Temperature	-40°C ~ 85°C
Relative Humidity	5% ~ 90% Non-condensing
Operating Altitude	2,000m
Mounting	DIN Rail
General Specification	
Shock Operating	IEC 60068-2-27: 2008/ 15g, 11bs
Vibration Resistance	Based on IEC 60068-2-6 DNVGL-CG-0039: 2016 / Vibration Class B, 4g
Industrial Emissions	EN61000-6-4: 2007 +A1: 2011
Industrial Immunity	EN61000-6-2: 2005
Protection Class	Variable / IP20
Installation Position	Vertical and horizontal installation is possible.
Product Certifications	CE, UL, EAC

3.2.5 Specification

Items																													
Input Specification																													
Inputs Per Module	8 Channels																												
Indicators	8 Green Input Status LEDs																												
Sensor Types	RTD Input Range																												
	<table border="1"> <thead> <tr> <th>RTD Input</th> <th>Input Range</th> </tr> </thead> <tbody> <tr> <td>PT100, PT200, PT500, PT50</td> <td>-200 ~ 850°C</td> </tr> <tr> <td>PT1000</td> <td>-200 ~ 350°C</td> </tr> <tr> <td>JPT100, JPT200, JPT500, JPT50</td> <td>-200 ~ 640°C</td> </tr> <tr> <td>JPT1000</td> <td>-200 ~ 350°C</td> </tr> <tr> <td>NI100, NI200, NI500</td> <td>-60 ~ 250°C</td> </tr> <tr> <td>NI1000</td> <td>-60 ~ 180°C</td> </tr> <tr> <td>NI120</td> <td>-80 ~ 260°C</td> </tr> <tr> <td>NI1000LG</td> <td>-50 ~ 120°C</td> </tr> <tr> <td>Resistance Input</td> <td>Input Range</td> </tr> <tr> <td>100mΩ/Bit</td> <td>0 ~ 2000Ω</td> </tr> <tr> <td>10mΩ/Bit</td> <td>0 ~ 327Ω</td> </tr> <tr> <td>20mΩ/Bit</td> <td>0 ~ 620Ω</td> </tr> <tr> <td>50mΩ/Bit</td> <td>0 ~ 1200Ω</td> </tr> </tbody> </table>	RTD Input	Input Range	PT100, PT200, PT500, PT50	-200 ~ 850°C	PT1000	-200 ~ 350°C	JPT100, JPT200, JPT500, JPT50	-200 ~ 640°C	JPT1000	-200 ~ 350°C	NI100, NI200, NI500	-60 ~ 250°C	NI1000	-60 ~ 180°C	NI120	-80 ~ 260°C	NI1000LG	-50 ~ 120°C	Resistance Input	Input Range	100mΩ/Bit	0 ~ 2000Ω	10mΩ/Bit	0 ~ 327Ω	20mΩ/Bit	0 ~ 620Ω	50mΩ/Bit	0 ~ 1200Ω
	RTD Input	Input Range																											
	PT100, PT200, PT500, PT50	-200 ~ 850°C																											
	PT1000	-200 ~ 350°C																											
	JPT100, JPT200, JPT500, JPT50	-200 ~ 640°C																											
	JPT1000	-200 ~ 350°C																											
	NI100, NI200, NI500	-60 ~ 250°C																											
	NI1000	-60 ~ 180°C																											
	NI120	-80 ~ 260°C																											
	NI1000LG	-50 ~ 120°C																											
	Resistance Input	Input Range																											
	100mΩ/Bit	0 ~ 2000Ω																											
	10mΩ/Bit	0 ~ 327Ω																											
20mΩ/Bit	0 ~ 620Ω																												
50mΩ/Bit	0 ~ 1200Ω																												
Excitation Current	About 1mA																												
Connection Method	3-Wire																												
Conversion Time	280ms / All Channel																												
Data Format	16 Bits signed Integer (2' complement)																												
Module Accuracy	PT100, PT1000 Type Input Range - 0.5°C Full Scale @ 25°C ambient All Type Input Range - ±0.1% Full Scale @ 25°C ambient - ±0.3% Full Scale @ -40 ~ 70°C ambient																												
Resolution of Data	RTD Type : ±0.1°C / F, Resistance Type : 100mΩ, 10mΩ, 20mΩ, 50mΩ																												
Calibration	Not Required																												
Diagnostic	Sensor open or range over, then conversion data = 0x8000 (-32768)																												
General Specification																													
Power Dissipation	Max. 120mA @ 5Vdc																												
Isolation	I/O to Logic: Isolation Field power: Not Connected																												

UL Field Power	Supply voltage: 24Vdc nominal, Class 2
Field Power	Not used, Field Power passes through to the next module
Wiring	Connector Type, up to AWG22 Module Connector: HIF3BA-20D-2.54DSA
Weight	60g
Module Size	12mm x 99mm x 70mm
Environment Condition	Refer to 'Environment Specification'

3.2.6 Mapping Data into the Image Table

Input Module Data

Analog Input Ch0
Analog Input Ch1
Analog Input Ch2
Analog Input Ch3
Analog Input Ch4
Analog Input Ch5
Analog Input Ch6
Analog Input Ch7

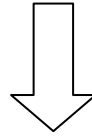

Input Image Value

Bit No	Bit7	Bit6	Bit5	Bit4	Bit3	Bit2	Bit1	Bit0
Byte 0	Analog Input Ch0 Low byte							
Byte 1	Analog Input Ch0 High byte							
Byte 2	Analog Input Ch1 Low byte							
Byte 3	Analog Input Ch1 High byte							
Byte 4	Analog Input Ch2 Low byte							
Byte 5	Analog Input Ch2 High byte							
Byte 6	Analog Input Ch3 Low byte							
Byte 7	Analog Input Ch3 High byte							
Byte 8	Analog Input Ch4 Low byte							
Byte 9	Analog Input Ch4 High byte							
Byte 10	Analog Input Ch5 Low byte							
Byte 11	Analog Input Ch5 High byte							
Byte 12	Analog Input Ch6 Low byte							
Byte 13	Analog Input Ch6 High byte							
Byte 14	Analog Input Ch7 Low byte							
Byte 15	Analog Input Ch7 High byte							

If the input of channel is open or over-ranged, its conversion data will be 0x8000(-32678)

3.2.7 Configuration Parameter – 18 Bytes

Byte	Decimal Bit	Description	Default Value
0	00-07	The selection Sensor Type =00h: PT100, 0.00385, -200~850°C, 0.1°C /count =01h: PT200, 0.00385, -200~850°C, 0.1°C/count =02h: PT500, 0.00385, -200~850°C, 0.1°C/count =03h: PT1000, 0.00385, -200~350°C, 0.1°C/count =04h: PT50, 0.00385, -200~850°C, 0.1°C/count =10h: JPT100, 0.003916, -200~640°C, 0.1°C/count =11h: JPT200, 0.003916, -200~640°C, 0.1°C/count =12h: JPT500, 0.003916, -200~640°C, 0.1°C/count =13h: JPT1000, 0.003916, -200~350°C, 0.1°C/count =14h: JPT50, 0.003916, -200~640°C, 0.1°C/count =20h: NI100, 0.00618, -60~250°C, 0.1°C/count =21h: NI200, 0.00618, -60~250°C, 0.1°C/count =22h: NI500, 0.00618, -60~250°C, 0.1°C/count =23h: NI1000, 0.00618, -60~180°C, 0.1°C/count =30h: NI120, 0.00672, -80~250°C, 0.1°C/count =53h: NI1000LG, 0.00500, -50~120°C, 0.1°C/count =80h: Resistance Input, 1~2000Ω, 100mΩ /1count =81h: Resistance Input, 1~327Ω, 10mΩ /1count =82h: Resistance Input, 1~620Ω, 20mΩ /1count =83h: Resistance Input, 1~1200Ω, 50mΩ/1count =Others: Reserved	0: PT100
1	00	Temperature Type 0: Celsius(°C), 1: Fahrenheit(°F)	0: Celsius(°C)
	01	Reserved	0
	02	Data Resolution 0: 0.1°C, °F / Bit, 1: 1°C, °F / Bit	0
	03	Reserved	0
	04	Filter Type 0: Normal Filter, 1: Enhanced Filter	0: Normal Filter
	05-07	Reserved	0
2~3	-	CH0 Offset Value	0
4~5	-	CH1 Offset Value	0
6~7	-	CH2 Offset Value	0
8~9	-	CH3 Offset Value	0
10~11	-	CH4 Offset Value	0
12~13	-	CH5 Offset Value	0
14~15	-	CH6 Offset Value	0
16~17	-	CH7 Offset Value	0

3.2.8 Data Value

Resistance Temperature Detector Input Range	
Type	Input Range
PT100	-200 ~ 850 °C
PT200	-200 ~ 850 °C
PT500	-200 ~ 850 °C
PT1000	-200 ~ 350 °C
PT50	-200 ~ 850 °C
JPT100	-200 ~ 640 °C
JPT200	-200 ~ 640 °C
JPT500	-200 ~ 640 °C
JPT1000	-200 ~ 350 °C
JPT50	-200 ~ 640 °C
NI100	-60 ~ 250 °C
NI200	-60 ~ 250 °C
NI500	-60 ~ 250 °C
NI1000	-60 ~ 180 °C
NI120	-80 ~ 260 °C
NI1000LG	-50 ~ 120 °C
Resistance Input Range	
Type	Input Range
100mΩ/Bit	0 ~ 2000Ω
10mΩ/Bit	0 ~ 327Ω
20mΩ/Bit	0 ~ 620Ω
50mΩ/Bit	0 ~ 1200Ω

3.3 RIO3-TC4T

3.3.1 Wiring Diagram

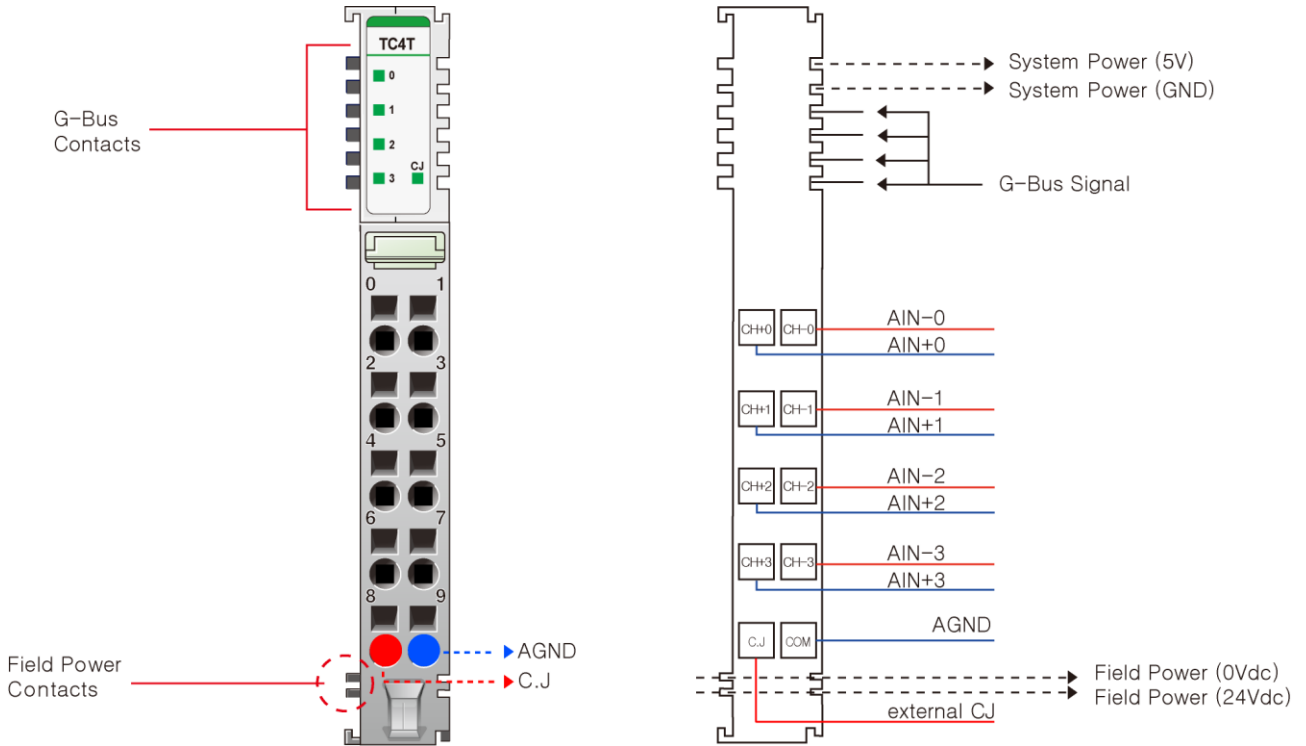
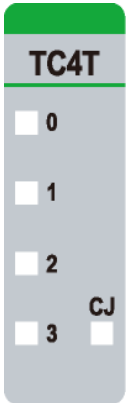

Figure 1. Customer Wiring to Mounting Base

Pin No.	Signal Description	Signal Description	Pin No.
0	TC Channel 0+	TC Channel 0-	1
2	TC Channel 1+	TC Channel 1-	3
4	TC Channel 2+	TC Channel 2-	5
6	TC Channel 3+	TC Channel 3-	7
8	CJ	AGND	9

3.3.2 LED Indicator



LED No.	LED Function / Description	LED Color
0	Input Channel 0	Green
1	Input Channel 1	Green
2	Input Channel 2	Green
3	Input Channel 3	Green
CJ	Input Channel CJ	Green

3.3.3 Channel Status LED

Status	LED	To indicate
No Signal	Channel LED Off, CJ LED Off	Input Sensor Open or Input Range Over
Normal Operation		Normal Operation
On Signal	Channel LED On, CJ LED Off	Sensor Connected and Input Range Valid
Normal Operation		Normal Operation
On Signal	Channel LED On, CJ LED On	Sensor Connected and Input Range Valid
Normal Operation		Normal Operation
Connected External CJC		External CJ Enable

3.3.4 Environment Specification

Environmental Specification	
Operation Temperature	-40°C ~ 70°C
UL Temperature	-20°C ~ 60°C
Storage Temperature	-40°C ~ 85°C
Relative Humidity	5% ~ 90% Non-condensing
Operating Altitude	2,000m
Mounting	DIN Rail
General Specification	
Shock Operating	IEC 60068-2-27: 2008/ 15g, 11bs
Vibration Resistance	Based on IEC 60068-2-6 DNVGL-CG-0039: 2016/ 6 vibration Class B, 4g
Industrial Emissions	EN61000-6-4: 2007 +A1: 2011
Industrial Immunity	EN61000-6-2: 2005
Protection Class	Variable / IP20
Installation Position	Vertical and horizontal installation is possible
Product Certifications	CE, UL, EAC

3.3.5 Specification

Items	Specification																																																
Input Specification																																																	
Inputs Per Module	4 Channels																																																
Indicators	4 Green Input Status LEDs , 1 Green Input CJ Status LED																																																
Sensor Types	Thermal Couple Input Range																																																
	<table border="1"> <thead> <tr> <th>Type</th> <th>Maximum Input Range</th> <th>Recommended Input Range</th> </tr> </thead> <tbody> <tr> <td>K</td> <td>-270 ~ 1372°C</td> <td>-200 ~ 1200°C</td> </tr> <tr> <td>J</td> <td>-210 ~ 1200°C</td> <td>-40 ~ 1100°C</td> </tr> <tr> <td>T</td> <td>-270 ~ 400°C</td> <td>-200 ~ 350°C</td> </tr> <tr> <td>B</td> <td>30 ~ 1820°C</td> <td>600 ~ 1700°C</td> </tr> <tr> <td>R</td> <td>-50 ~ 1768°C</td> <td>0 ~ 1600°C</td> </tr> <tr> <td>S</td> <td>-50 ~ 1768°C</td> <td>0 ~ 1600°C</td> </tr> <tr> <td>E</td> <td>-270 ~ 1000°C</td> <td>-200 ~ 800°C</td> </tr> <tr> <td>N</td> <td>-270 ~ 1300°C</td> <td>-200 ~ 1250°C</td> </tr> <tr> <td>L</td> <td>-200 ~ 900°C</td> <td>-100 ~ 850°C</td> </tr> <tr> <td>U</td> <td>-200 ~ 600°C</td> <td>-100 ~ 550°C</td> </tr> <tr> <td>C</td> <td>0 ~ 2310°C</td> <td>100 ~ 2100°C</td> </tr> <tr> <td>D</td> <td>0 ~ 2490°C</td> <td>100 ~ 2200°C</td> </tr> <tr> <td>10uV Input</td> <td colspan="2">-81.0 ~ 81.0mV, 10uV/1 Count</td> </tr> <tr> <td>1uV Input</td> <td colspan="2">-32.7 ~ 32.7mV, 1uV/1 Count</td> </tr> <tr> <td>2uV Input</td> <td colspan="2">-65.5 ~ 65.5mV, 2uV/1 Count</td> </tr> </tbody> </table>	Type	Maximum Input Range	Recommended Input Range	K	-270 ~ 1372°C	-200 ~ 1200°C	J	-210 ~ 1200°C	-40 ~ 1100°C	T	-270 ~ 400°C	-200 ~ 350°C	B	30 ~ 1820°C	600 ~ 1700°C	R	-50 ~ 1768°C	0 ~ 1600°C	S	-50 ~ 1768°C	0 ~ 1600°C	E	-270 ~ 1000°C	-200 ~ 800°C	N	-270 ~ 1300°C	-200 ~ 1250°C	L	-200 ~ 900°C	-100 ~ 850°C	U	-200 ~ 600°C	-100 ~ 550°C	C	0 ~ 2310°C	100 ~ 2100°C	D	0 ~ 2490°C	100 ~ 2200°C	10uV Input	-81.0 ~ 81.0mV, 10uV/1 Count		1uV Input	-32.7 ~ 32.7mV, 1uV/1 Count		2uV Input	-65.5 ~ 65.5mV, 2uV/1 Count	
	Type	Maximum Input Range	Recommended Input Range																																														
	K	-270 ~ 1372°C	-200 ~ 1200°C																																														
	J	-210 ~ 1200°C	-40 ~ 1100°C																																														
	T	-270 ~ 400°C	-200 ~ 350°C																																														
	B	30 ~ 1820°C	600 ~ 1700°C																																														
	R	-50 ~ 1768°C	0 ~ 1600°C																																														
	S	-50 ~ 1768°C	0 ~ 1600°C																																														
	E	-270 ~ 1000°C	-200 ~ 800°C																																														
	N	-270 ~ 1300°C	-200 ~ 1250°C																																														
	L	-200 ~ 900°C	-100 ~ 850°C																																														
	U	-200 ~ 600°C	-100 ~ 550°C																																														
	C	0 ~ 2310°C	100 ~ 2100°C																																														
	D	0 ~ 2490°C	100 ~ 2200°C																																														
10uV Input	-81.0 ~ 81.0mV, 10uV/1 Count																																																
1uV Input	-32.7 ~ 32.7mV, 1uV/1 Count																																																
2uV Input	-65.5 ~ 65.5mV, 2uV/1 Count																																																
Module Accuracy (Need 20 minute preheating to get enhanced accuracy.)	Recommend Input Range - $\pm 0.1\%$ Recommended Scale @ 25°C ambient - $\pm 0.3\%$ Recommended Scale @ -40°C ~ 70°C C/D Type Recommend Input Range - $\pm 0.3\%$ Recommended Scale @ -40°C ~ 70°C External Cold Junction(PT100) - $\pm 2^\circ\text{C}$ Recommended Scale @ -40°C ~ 70°C																																																
Connection Method	2-Wire																																																
Conversion Time	Average Conversion Time < 30ms																																																
Data Format	16 Bits Integer (2' complement)																																																
Calibration	Not Required																																																

Cold Junction Temperature	Internal - TMP275AIDGKR: -40°C ~ 125°C External - PT100: -45°C ~ 95°C
Calibration	Not Required
Diagnostic	Sensor open or range over, then conversion data = 0x8000 (-32768) *Connected External CJ: CJ LED On. Not Connected External CJ: CJ LED Off.

General Specification	
Power Dissipation	Max. 130mA @ 5Vdc
Isolation	I/O to Logic: Isolation Field power: Not Connected
UL Field Power	Supply voltage : 24Vdc nominal, Class 2
Field Power	Not used, Field Power passes through to the next module
Wiring	I/O Cable Max. 2.0mm ² (AWG 14)
Torque	0.8Nm (7lb-in)
Weight	60g
Module Size	12mm x 99mm x 70mm
Environment Condition	Refer to 'Environment Specification'

* To increase precision of measurement, the connection between RIO3-TC4T and compensation reference sensor is recommended using by terminal block.

3.3.6 Mapping Data into the Image Table

Input Module Data

Analog Input Ch0
Analog Input Ch1
Analog Input Ch2
Analog Input Ch3

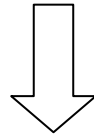

Input Image Value

Bit No	Bit7	Bit6	Bit5	Bit4	Bit3	Bit2	Bit1	Bit0
Byte 0	Analog Input Ch0 Low byte							
Byte 1	Analog Input Ch0 High byte							
Byte 2	Analog Input Ch1 Low byte							
Byte 3	Analog Input Ch1 High byte							
Byte 4	Analog Input Ch2 Low byte							
Byte 5	Analog Input Ch2 High byte							
Byte 6	Analog Input Ch3 Low byte							
Byte 7	Analog Input Ch3 High byte							

If the input of channel is open or over-ranged, its conversion data will be 0x8000 (-32678)

3.3.7 Configuration Parameter – 8 Bytes

Byte	Decimal Bit	Description	Default Value
0	00-07	The selection Sensor Type =00h: Type K, 0.1°C/count =01h: Type J, 0.1°C/count =02h: Type T, 0.1°C/count =03h: Type B, 0.1°C/count =04h: Type R, 0.1°C/count =05h: Type S, 0.1°C/count =06h: Type E, 0.1°C/count =07h: Type N, 0.1°C/count =08h: Type L; 0.1°C/count =09h: Type U, 0.1°C/count =0Ah: Type C, 0.1°C/count =0Bh: Type D, 0.1°C/count =80h: 10uV Input, -81.0~81.0mV, 10uV / 1count =81h: 1uV Input, -32.7~32.7mV, 1uV / 1count =82h: 2uV Input, -65.5~65.5mV, 2uV / 1count =Others: Reserved	00: Type K
1	00	Temperature Type 0: Celsius(°C), 1: Fahrenheit(°F)	00: Celsius (°C) Cold Junction Compensation 0.1°C Normal Filter
	01*	0: Cold Junction Compensation 1: Disable Cold Junction Compensation	
	02	Data Resolution 0: 0.1°C, °F/bit, 1: 1°C, °F/bit	
	03	Reserved	
	04	Filter Type 0: Normal Filter, 1: Enhanced Filter	
	05-07	Reserved	
2	00-07	Internal Cold Junction[1] Offset Data Low Byte	0000
3	00-07	Internal Cold Junction[1] Offset Data High Byte	
4	00-07	Internal Cold Junction[2] Offset Data Low Byte	0000
5	00-07	Internal Cold Junction[2] Offset Data High Byte	
6	00-07	External Cold Junction Offset Data Low Byte	0000
7	00-07	External Cold Junction Offset Data High Byte	

- Unit of Cold Junction Temperature is 0.1°C/°F. Value 254 means 25.4°C or 25.4°F

- *0: Compensation ColdJunction Temperature = ColdJunction Temperature – ColdJunction Temperature Offset

- *1: Compensation Cold Junction Temperature = Cold Junction Temperature Offset

- *If you set a fast filter, the specification accuracy may not be met.

3.3.8 Data Value

Thermocouple Input Range		
Type	Maximum Input Range	Recommended Input Range
Type K	-270 ~ 1372 °C	-200 ~ 1200 °C
Type J	-210 ~ 1200 °C	-40 ~ 1100 °C
Type T	-270 ~ 400 °C	-200 ~ 350 °C
Type B	30 ~ 1820 °C	600 ~ 1700 °C
Type R	-50 ~ 1768 °C	0 ~ 1600 °C
Type S	-50 ~ 1768 °C	0 ~ 1600 °C
Type E	-270 ~ 1000 °C	-200 ~ 800 °C
Type N	-270 ~ 1300 °C	-200 ~ 1250 °C
Type L	-200 ~ 900 °C	-100 ~ 850 °C
Type U	-200 ~ 600 °C	-100 ~ 550 °C
Type C	0 ~ 2310 °C	100 ~ 2100 °C
Type D	0 ~ 2490 °C	100 ~ 2200 °C
10uV	-81.0 ~ 81.0mV, 10uV / 1 Count	
1uV	-32.7 ~ 32.7mV, 1uV / 1 Count	
2uV	-65.5 ~ 65.5mV, 2uV / 1 Count	

$$1^{\circ}F = 1.8^{\circ}C + 32$$

4 Dimension

4.1 10-Pts. Spring Type

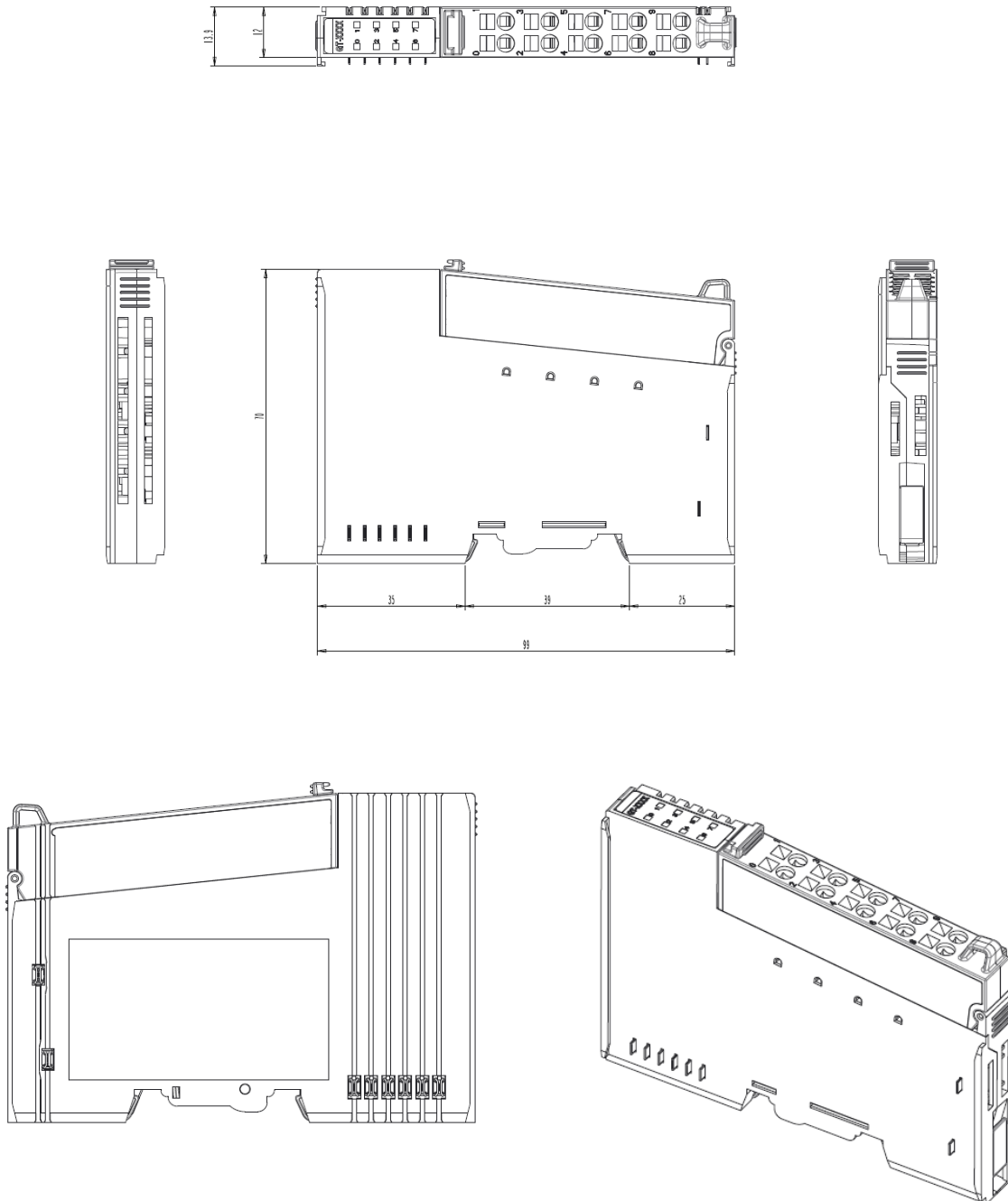

Dimension in mm

4.2 20-Pin Connector Type

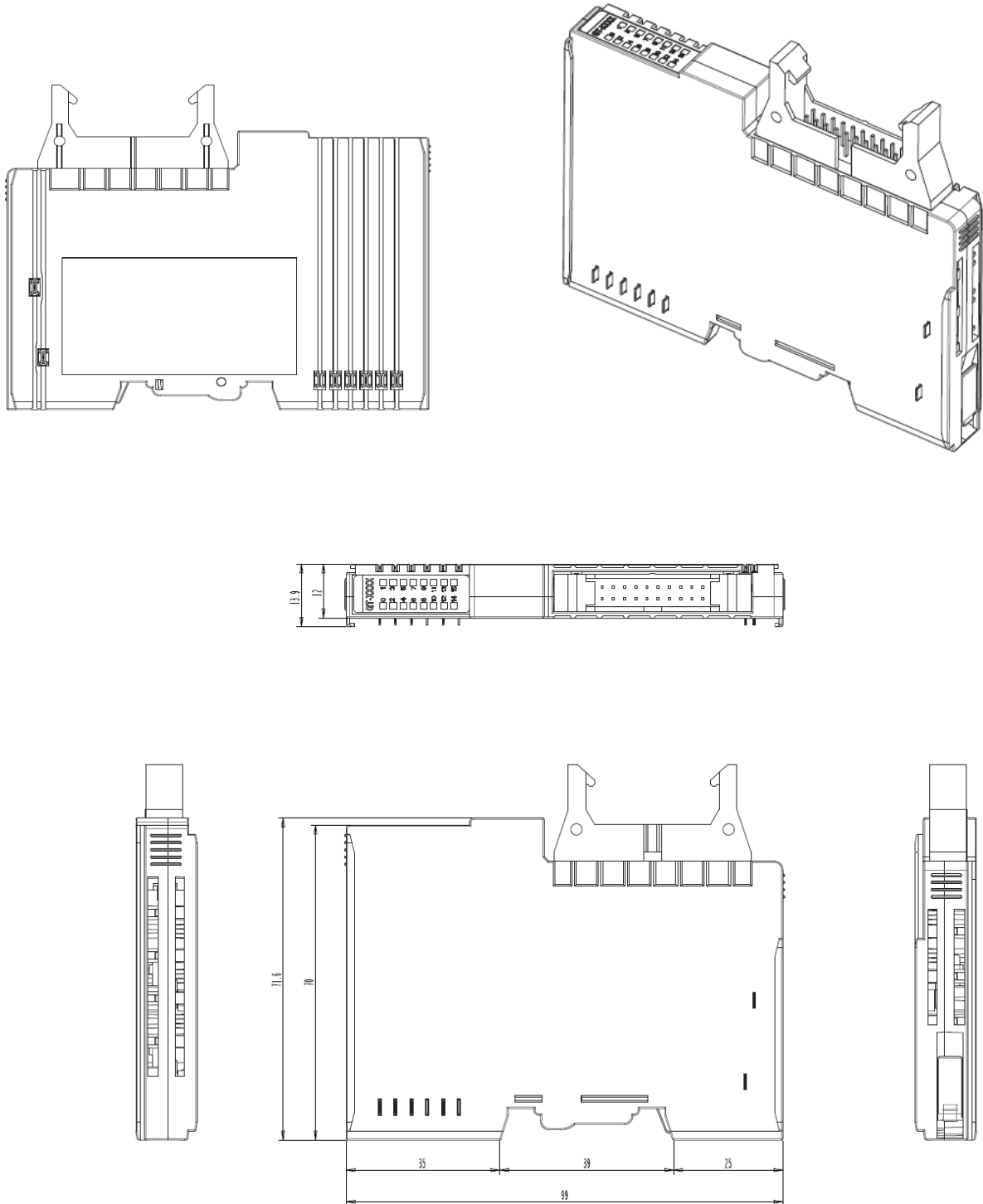

Dimension in mm

5 Mounting

Caution!

Hot surface!

The surface of the housing can become hot during operation. If the device was operated at high ambient temperatures, allow it to be cool before touching it.

Notice!

Perform work on devices only if they are de-energized!

Working on energized devices can damage them. Therefore, turn off the power supply before working on the devices.

5.1 I/O Inserting and Removing Devices

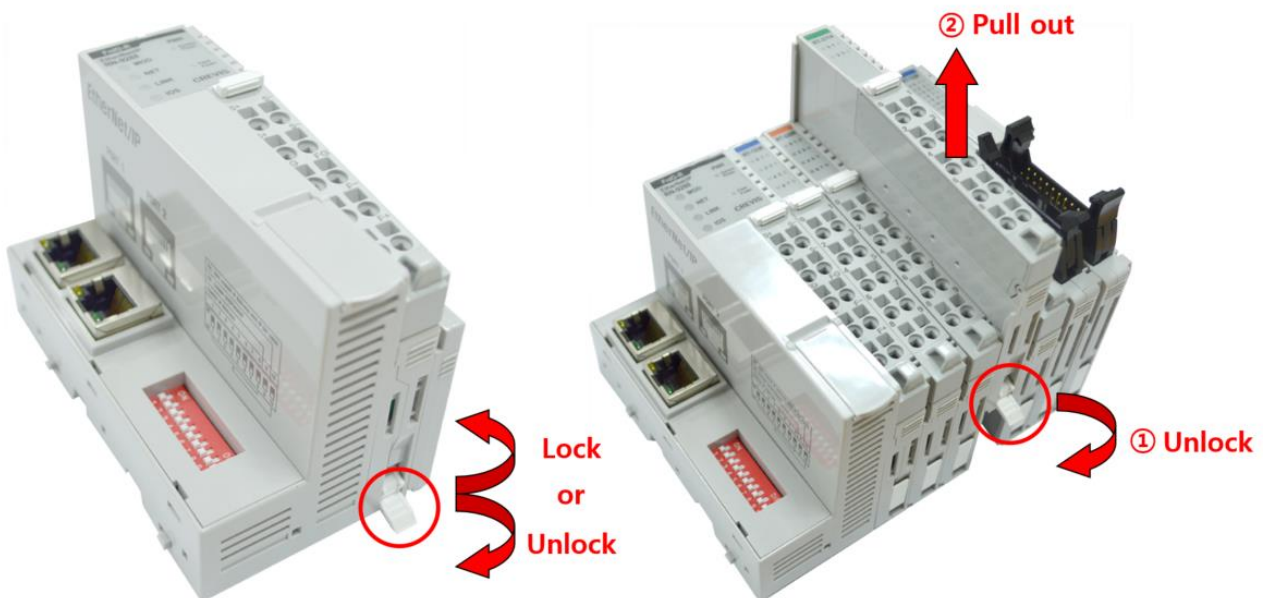

As above figure in order to safeguard the RIO3-Series module from jamming, it should be fixed onto the DIN rail with locking lever. To do so, fold on the upper of the locking lever.

To pull out the RIO3-Series module, unfold the locking lever as below figure.

5.2 RTB (Removable Terminal Block)

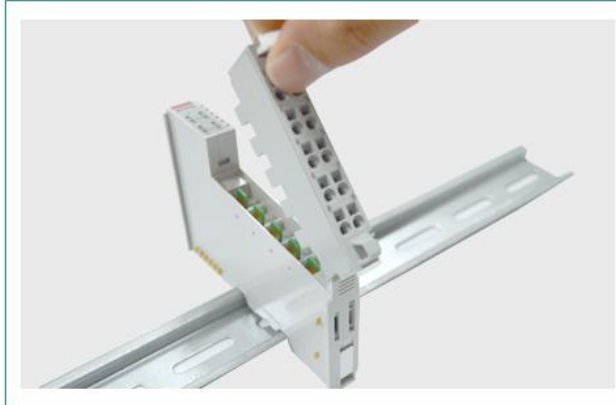
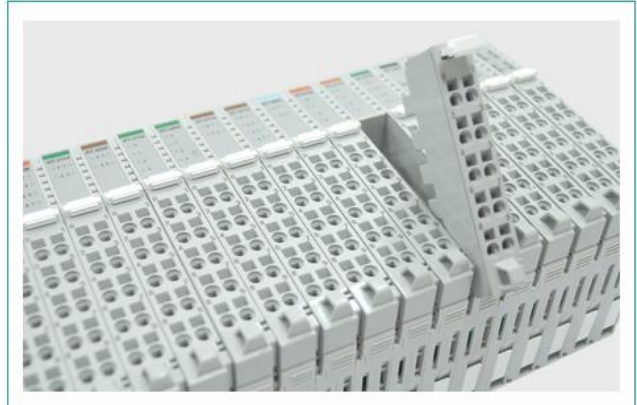
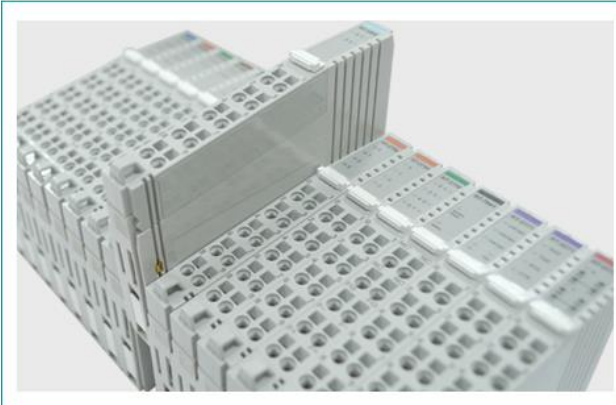

Whole terminal block can be combined and removed for the convenience.
There is a locking switch on the RTB for the easy combination and easy removal.
Easy combination and easy removal for I/O modules on the DIN rail through One Touch Locking Switch.

6 G-Bus Pin Description

Communication between the Network Adapter and the expansion module as well as system / field power supply of the bus modules is carried out via the internal bus. It is comprised of 6 data pin and 2 field power pin.



*Please refer to the table below regarding the pin description from P1 to P8.

No.	Description
P1	Field Power (VCC)
P2	Field Power (GND)
P3	GBUS CLK
P4	GBUS MISO
P5	GBUS MOSI
P6	GBUS Token
P7	System Power (GND)
P8	System Power (VCC)

DANGER



Do not touch data and field power pins in order to avoid soiling and damage by ESD noise.

7 APPENDIX

7.1 Product List

No.	RIO3-Number	Description	ID (hex)
Digital Input Module			
01	RIO3-XDP8	8 Points, Universal, 24Vdc, 10RTB	1238
02	RIO3-XDP16C	16 Points, Universal, 24Vdc, 20P connector	123F
03	RIO3-XDP16T	16 Points, Universal, 24Vdc, 18RTB	12DF
04	RIO3-XDP32C	32 Points, Universal, 24Vdc, 40P connector	12FA
05	RIO3-XY16T	8 Sink Input / 8 Source Output with Diagnostic, 24Vdc	1428
06	RIO3-XAH4	4 Points, 240Vac, 10RTB	1904
Digital Output Module			
07	RIO3-YTP8	8 Points, Source, 24Vdc/0.5A, 10RTB	2328
08	RIO3-YTP16C	16 Points, Source, 24Vdc/0.3A, 20P connector	222F
09	RIO3-YTP16T	16 Points, Source, 24Vdc/0.3A, 18RTB	226F
10	RIO3-YTP32C	32 Points, Source, 24Vdc/0.3A, 40P connector	22CA
11	RIO3-YS4	4 Points, MOS Relay, 240Vdc/ac, 0.5A, 10RTB	2734
12	RIO3-YS8	8 Points, MOS Relay Output Terminal, 240Vdc, 0.5A	2738
13	RIO3-YR4	4 Points, Relay, 24Vdc/2A, 240Vac/2A, 10RTB	2744
Analog Input Module			
14	RIO3-LDC2	2ch load cell input unit, strain gauge	3002
15	RIO3-AX4I	4 Channels, 0~20, 4~20mA, 12bits, 10RTB	3114
16	RIO3-AXH4I	4 Channels, 0~20, 4~20mA, 16bits, 10RTB	3154
17	RIO3-AX8I	8 Channels, 0~20, 4~20mA, 12bits, 10RTB	3118
18	RIO3-AXH8I	8 Channels, 0~20, 4~20mA, 16bits, 10RTB	3158
19	RIO3-AX16IC	16 Channels, 0~20, 4~20mA, 12bits, 20P connector	311F
20	RIO3-AX16IT	16 Channels, 0~20, 4~20mA, 12bits, 18RTB	317F
21	RIO3-AX4V	4 Channels, 0~10, 0~5, 1~5Vdc, 12bits, 10RTB	3424
22	RIO3-AXH4V	4 Channels, 0~10, 0~5, 1~5Vdc, 16bits, 10RTB	3464
23	RIO3-AX8V	8 Channels, 0~10, 0~5, 1~5Vdc, 12bits, 10RTB	3428
24	RIO3-AXH8V	8 Channels, 0~10, 0~5, 1~5Vdc, 16bits, 10RTB	3468
25	RIO3-AX16VC	16 Channels, 0~10, 0~5, 1~5Vdc, 12bits, 20P connector	342F
26	RIO3-AX16VT	16 Channels, 0~10, 0~5, 1~5Vdc, 12bits, 18RTB	347F
27	RIO3-RTD4T	4 Channels, RTD, 10RTB	3704
28	RIO3-RTD8C	8 Channels, RTD, 20P connector	3708
29	RIO3-TC4T	4 Channels, Thermocouple, 10RTB	3804
30	RIO3-E3AC	AC Measurement	3901
Analog Output Module			
31	RIO3-AY4I	4 Channels, Current Output, 4~20mA, 12bits	4214
32	RIO3-AYH4I	4 Channels, Current Output, 4~20mA, 16bits	4254

33	RIO3-AY8I	8 CHANNELS CURRENT OUTPUT, 4~20mA, 12BIT	4218
34	RIO3-AY4V	4CH, 0~10Vdc, 12Bits, 10RTB	4424
35	RIO3-AYH4V	4CH, 0~10Vdc, 16Bits, 10RTB	4464
36	RIO3-AY8V	8CH, 0~10Vdc, 12Bits, 10RTB	4428
37	RIO3-AY16VC	16CH, 0~10Vdc, 12Bits, 20P Connector	442F
38	RIO3-AY16VT	16CH, 0~10Vdc, 12Bits, 18RTB	447F
Special Module			
39	RIO3-CU24L	High Speed Counter, 2CHs, 24Vdc, Encoder Input, 10RTB	
40	RIO3-RS232	1CH, RS 232, RTS/CTS, Full Duplex Type, 10RTB	5211
41	RIO3-RS485	1CH, RS 485, Half Full Duplex Type, 10RTB	5231
42	RIO3-PWM2	PWM Output, 2CHs, 0.5A/24Vdc, Source, 18RTB	5442
43	RIO3-PO2	Pulse Output, 2CHs, 0.5A/24Vdc, Source, 18RTB	5642
Power Module			
44	RIO3-SHD	Shield Module	7408
45	RIO3-0VDC	Common for 0Vdc	7508
46	RIO3-PSD	Power Expansion, In 24Vdc, Out 1A/5Vdc	7511
47	RIO3-24VDC	Common for 24Vdc	7518
48	RIO3-VDC	Common for 0Vdc, 24Vdc	7588
49	RIO3-PS	Field Power, 5/24/48 Vdc, 110/220 Vac	7641

7.2 Glossary

System Power: The power for starting up CPU.

Field Power: The power for input and output line.

Terminator Resistor: Resistor for prevention reflected wave.

EDS: Electronic Data Sheet.

Sink: The method of in/output power supply if a device has no power source.

Source: The method of in/output power supply if a device has the power source.