

PacDrive™

Power Supply PS-5 and Distribution Box DB-5



Legal notice

© All rights reserved to ELAU AG, also in case of patent right applications.
No part of this documentation or the accompanying software and firmware may be reproduced, transferred, paraphrased, saved to a storage medium or translated to another language or computer language without the written consent of ELAU AG. Any possible measure was taken to ensure that this product documentation is complete and correct. However, since hardware and software are continuously improved, ELAU makes no representations or warranties with respect to the contents of this documentation.

Trademark

PacDrive is a registered trademark of ELAU AG.
All other trademarks mentioned in this documentation are the exclusive property of their manufacturers.

ELAU AG
Dillberg 12
97828 Marktheidenfeld, Germany

Tel.: +49 (0) 9391 / 606 - 0
Fax: +49 (0) 9391 / 606 - 300

E-mail: info@elau.de
Internet: www.elau.de

	<p style="text-align: center;">Manufacturer's declaration According to the EC machine guidelines 98/37/EC</p>	<p style="text-align: center;">ELN 124-00/01.08 page 1/1</p>
---	--	--

The product we delivered:

PacDrive Power Supply PS-5
PacDrive Distribution Box DB-5

is intended for installation in a machine.

Commissioning is forbidden until it is established that the machine in which this product is to be installed complies with the provisions of the EC guideline. The manufacturer guarantees that the product delivered was manufactured in accordance with the applied harmonized standards / specifications.

The following standards were applied:

- **EN 60204-1 (2007)** Safety of machinery: Electrical equipment of machines - General requirements
- **EN 50081-2 (3/1994)** Electromagnetic compatibility. Generic emission standard
- **EN 61000-6-2 (3/2000)** Electromagnetic compatibility. Resistance to jamming

Manufacturer:

ELAU AG
Dillberg 12
97828 Markttheidenfeld, Germany

2008-01-10

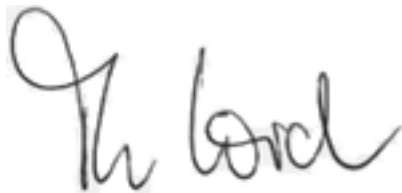

Thomas Cord
Chief Executive Officer

Contents

1	About this Manual	6
1.1	Introduction	6
1.2	Symbols, designator and display format of safety notes	7
2	Safety instructions	8
2.1	Principle	8
2.2	Proper use	9
2.3	Selection and qualification of personnel	10
2.4	Residual risks	11
3	Overview	14
3.1	PacDrive System	14
4	Indicators, control elements, diagnosis	16
4.1	Indicators and control elements	16
4.1.1	PacDrive Power Supply PS-5	16
4.1.2	PacDrive Distribution Box DB-5	20
4.2	Example of a diagnostic message	21
5	Transport, storage, unpacking	22
5.1	Transport	22
5.2	Storage	22
5.3	Unpacking	22
5.4	Type Plate	23
6	Installation and maintenance	25
6.1	Initial start-up	25
6.2	Configuration, homing and programming	28
6.3	EMC Rules	29
6.4	Maintenance, repair, cleaning	30
6.5	Spare part inventory	30

6.6	Order numbers	31
6.6.1	Power Supply PS-5	31
6.6.2	Distribution Box DB-5	31
6.6.3	Options	31
6.6.4	Connection cable	32
6.7	Device replacement	33
6.7.1	PS-5	34
6.7.2	DB-5	35
6.8	Cable replacement	36
7	Planning	37
7.1	PacDrive PS-5 Mains Connection	37
7.2	Wiring notes	37
8	Technical data	40
8.1	Data tables	40
8.1.1	PacDrive Power Supply PS-5	40
8.1.2	PacDrive Distribution Box DB-5	41
8.2	Electrical connections	42
8.2.1	PacDrive Power Supply PS-5	42
8.2.2	PacDrive Distribution Box DB-5	45
8.3	Dimensions	46
9	Hybrid Connector iSH-HCN1	47
9.1	Technical data	47
9.2	Electrical connections	48
9.3	Dimensions	49
10	Appendix	50
10.1	Contact addresses	50
10.2	Product training courses	50
10.3	Changes	51
10.4	Fault report form	52

1 About this Manual

1.1 Introduction

Read this manual before you work on the ELAU component for the first time. Take particular note of the safety instructions. As described in section 2.4, only those persons who meet the Selection and qualification of employees are allowed to work on this unit.

A copy of this manual must always be available for personnel who are entrusted to work on the component.



This manual is intended to help you use the ELAU component and its intended applications safely and properly.

Follow the instructions in this manual. Doing so helps avoid hazards, minimize repair costs and downtime, extend service life and increase reliability.



You must also observe the rules and regulations on accident prevention and environmental protection that apply in the country where the product is used and at the installation location.

1.2 Symbols, designator and display format of safety notes

This manual divides the safety instructions into four various categories. Hazards and possible results will be categorized using a certain combination of symbols and signal words.

Symbol / Signal word	Meaning
 DANGER	Indicates an immediate hazardous situation that can lead to death or serious bodily injury if the safety regulations are not observed.
 WARNING	Indicates a potentially hazardous situation that can lead to serious injury or extensive property damage if the safety regulations are not observed.
 CAUTION	Indicates a potentially hazardous situation that may result in minor bodily harm or property damage if the safety regulations are not observed.
CAUTION	Indicates a potentially dangerous situation that may result in property damage if the safety regulations are not observed.

The following symbols and designators are used in this document:

Symbol/Character	Meaning
	Information symbol: After this symbol, you will find instructions and useful tips on using the components.
	Marker: After this symbol, you will find references for further information.
	Orientation aid: Information serving as an orientation aid regarding the section's contents follows this symbol..
Keyword	If the descriptive text contains technical terms (such as parameters), they are highlighted in bold.
<code>lBufSelect: AXIS_BUF_SELECTION; (* Buffer Auswahl *)</code>	Program code is written in a different font.
▪	First level bullet point or the requirement of a instruction
–	Second level bullet point.
▶	Activity symbol: The text after this symbol contains instructions. Follow the instructions in sequence from top to bottom.
✓	Result symbol: The text after this symbol contains the result of an action.

2 Safety instructions



This section contains general requirements for safe work. Each person who uses or works on the ELAU component must read and follow these general safety instructions.

If activities involve residual risks, a specific note is made at the appropriate points. The note details the potential hazard and describes preventative measures to avoid it.

2.1 Principle

The ELAU component is are state of the art and conform to recognized technical safety regulations. Nevertheless their use can present a hazard to life and limb or cause property damage, if:

- You do not use them as intended
- Work on them is not performed by specialists or other trained personnel
- You change or modify them inappropriately
- You neglect to test the protective measures in use after the installation, commissioning or repair
- You do not observe the safety notes and safety regulations.

The installation requires you to provide for appropriate protective device in compliance with the local and national standards. Commissioning without appropriate protective devices is expressly forbidden.

Operate the ELAU component only when they are in a flawless technical condition. Observe the regulations, act with safety and hazards in mind, and follow the instructions in this manual In order for of the component to run perfectly and safely, they must be transported, stored, installed, and assembled correctly and serviced carefully. If circumstances occur that impact safety or cause changes in the operating performance of the ELAU component, switch it off immediately and contact the responsible service engineer. As a supplement to this description, please observe:

- The regulative, warning, and instruction signs as well as the warning instructions on the component, the connected components, and all signs in the switching cabinet
- the operating instructions of the other components
- The generally applicable local and national safety and accident prevention regulations.
- the applicable laws and ordinances

2.2 Proper use

The ELAU component is are intended to be installed in a machine or assembled with other components to form a machine or system. You may only use them in accordance with the installation and operating conditions described in the documentation. Use only the options and add-ons specified in the documentation. You may not use any third-party devices or components that are not expressly approved by ELAU.

The ELAU components must not be used in the following environments:

- in dangerous (explosive) atmospheres
- in mobile, movable or floating systems
- in life support systems
- in domestic appliances

The ELAU component is part of the PacDrive System. The PacDrive System is the complete control system comprising of

- PacDrive Controller of C- or P-Series,
- PacDrive Servo amplifier MC-4 and
- PacDrive Motor.

For proper use, you must also:

- Observe the operating instructions and other documents and
- adhere to the inspection and maintenance instructions.

The operating conditions at the installation location must be checked and maintained in accordance with the required technical data (performance data and ambient conditions). Commissioning is prohibited until it is guaranteed that the usable machine or system in which the component is installed meets all requirements of EC Directive 98/37/EC (machinery directive).

In addition, the following standards, directives and regulations are to be observed:

- DIN EN 60204 Safety of machinery: Electrical equipment of machines
- DIN EN 292 Part 1 and Part 2 Safety of machinery: Basic Concepts, General Principles for Design
- DIN EN 50178 Electronic equipment for use in high-current electrical systems
- EMC directive 89/336/EEC : DINT

2.3 Selection and qualification of personnel

This description is geared exclusively toward technically qualified personnel, who have detailed knowledge in the field of automation technology. Only qualified personnel can recognize the importance of the safety instructions and implement them consistently.

The description is mainly for construction and application engineers from the engineering and electro-technics division as well as service and commissioning engineers.

Professional or training personnel

Work on the component may only be carried out by qualified professional or by trained staff under the instruction and supervision of a qualified person in accordance with electrical regulations. Work may only be carried out by qualified professional or by trained staff under the instruction and supervision of a qualified person in accordance with electrical regulations. Qualified persons are

- Evaluate the transferred work,
- Recognize possible hazards and
- Take appropriate safety measures.

2.4 Residual risks

Health risks arising from of the component have been reduced by means of safety technology and design engineering. However a residual risk remains, since the component works with electrical voltage and electrical currents.

Touching electrical parts

If parts have contact with voltages greater than 50 V, it can be a hazard for personnel. When electrical devices are in operation, certain parts of these devices must necessarily carry dangerous voltages.

DANGER

High voltage!
Electric shock, fire or explosion

- Observe the general construction and safety regulations for working on high-current electrical systems.
- After installation, check the fixed connection of the ground conductor to all electrical units to ensure that connection complies with the connection diagram.
- Generally, and also for brief measurements and inspections, operation is only allowed using a fixed connection from the ground conductor to all electrical components.
- Disconnect the unit from the power supply before working on electrical parts with a voltage greater than 50 volts. Prevent the unit from being switched back on. Wait at least 5 minutes after switching off before accessing the components. Check the voltage with a voltage meter before accessing the unit to be sure that the voltage is less than 50 volts.
- Do not touch the electrical connection points of the components when the unit is switched on.
- Before enabling the device, safely cover the live components to prevent contact.
- The following provides protection against indirect contact (DIN EN 50178, Section 5.3.2).

High leakage current

DANGER

High leakage current
Risk of death

- The leakage current is greater than 3.5 mA. This is why units require a fixed connection to the power supply network (in accordance to DIN EN 50178 - Equipping high-current electrical systems).

Touching hot surfaces

WARNING

Hot surfaces

Risk of burns from surface temperatures up to 100 °C.

- Wear safety gloves or wait until the surface temperature has cooled to allow safe contact!
- Attach protective cover or touch guard.

Dangerous Movements

There can be different causes of dangerous movements:

- Wiring or cabling errors
- Errors in the application program
- Component errors
- Error in the measured value and signal transmitter
- Operation error

Personal safety must be guaranteed by primary equipment monitoring or measures. Don't just rely on the internal monitoring of the drive components. Monitoring or measures should be implemented based on the specific characteristics of the equipment, in line with a risk and error analysis. This includes the valid safety regulations for the equipment. Under no circumstances must the technical safety devices be removed. Do not make any modifications to a protective device that may put it out of operation. Protect existing work stations against unauthorized operation. Effectively restrict access to the control terminals to allow access only to authorized persons.

DANGER

Dangerous Movements!

Risk of death, serious injury or property damage!

- Prevent entry to a danger zone, for example with protective fencing, mesh guards, protective coverings, or light barriers.
- Ensure the protective devices are properly dimensioned.
- Position EMERGENCY OFF switches so that they are easily accessible and can be quickly reached. The functionality of EMERGENCY OFF equipment should be checked before start-up and during maintenance periods.
- Prevent unintentional start-ups by disconnecting the power connection of the drive using the EMERGENCY OFF circuit or using a safe start-up lock out.
- Before accessing or entering the danger zone, safely bring the drives to a stop.
- While working on the system, power down the electrical equipment using the main switch and prevent it from being switched back on.
- Avoid operating high-frequency, remote control, and radio devices close to the unit and system electronics and their feed lines. If the use of such devices cannot be avoided, the system and the installation must be checked for possible malfunctions in all usage scenarios prior to the initial start-up. Where applicable, it is necessary to carry out a special EMC check of the system.

"Safe separated extra-low voltage"

PELV Protective Extra-Low Voltage

The signal voltage and control voltage of the PacDrive™ devices are <33 Volts. In this range, the specification as a PELV system in accordance with IEC 60364-4-41 includes a protective measure to guard against direct and indirect contact with danger-

ous voltage through **the safe separation** of the primary and secondary sides in the system/machine. ELAU strongly recommends providing the system/machine with safe isolation.

DANGER

**High voltage due to incorrect connection!
Risk of death or serious injury!**

- Please ensure that only devices, electrical components or lines that have sufficient, safe electrical separation from the connected circuits in accordance with the standards (EN 50178 / 1998 edition - Electronic equipment for use in power stations) are connected to the signal voltage connectors of this component.
- Ensure that the existing electrical separation is maintained throughout the entire circuit.

FELV Functional Extra-Low Voltage When using ELAU components in systems that do not have safe separation as a protective measure against direct or indirect contact of dangerous voltages, all connections and contacts (e.g. PacDrive controller, Sub-D connector, serial interface) that do not meet protection class IP2X require a permanent cover. The cover or the device connection of the connected device must be designed so that it can only be removed by using a tool. The protective measures have to be adhered on all connected devices.

3 Overview

3.1 PacDrive System

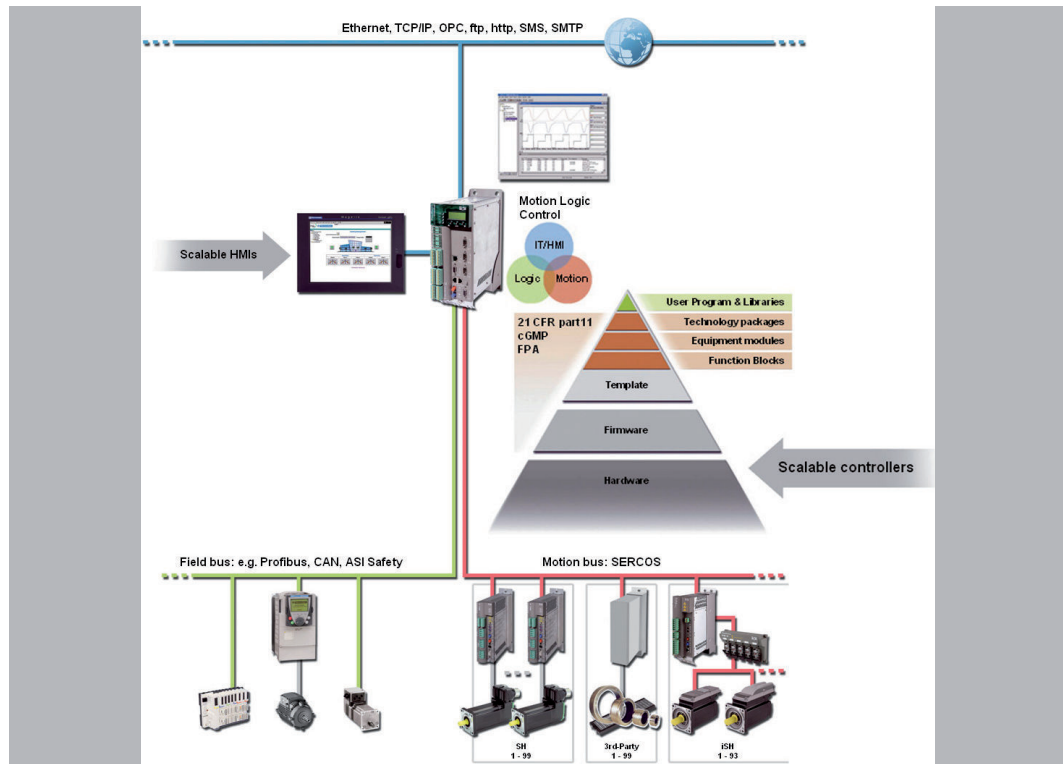

Figure 3-1: PacDrive System Overview

PacDrive Controller Family



The PacDrive controller, microprocessor-based control hardware with the VxWorks real-time operating system, centrally implements the PLC and motion functions. A PacDrive controller synchronizes, coordinates, and creates the motion functions for maximum

- 8 drives for the PacDrive controller C200
- 2 drives for the PacDrive controller C200 A2
- 16 drives for the PacDrive controller C400
- 8 drives for the PacDrive controller C400 A8
- 99 drives for the PacDrive controller C600

of a food and packaging machine.

Many different HMIs are used for the HMI tasks. Whether it is low-cost clear text or IPC, it is no problem for the flexible PacDrive Controller.

The PacDrive P600 controller is additionally equipped with a full-fledged PC. Due to its PC-based architecture, it can perform HMI tasks with no problem in addition to the usual motion functions.

PacDrive Power Supply PS-5



The PacDrive PS-5 power supply unit features modern technology and a compact and closed construction for switching cabinet installation. Each Pac Drive iSH has a Pac-Drive PS-5 that can be quickly installed with a single connection line. Which means that the PS-5 fits seamlessly into the extremely flexible, modular drive concept.

Highlights

- Integrated mains filter and bleeder
- Intermediate circuit power for up to 25 iSH (depending on the application)
- Integrated SERCOS interface
- fully diagnosable due to integrated controller
- simple to assemble

PacDrive Distribution Box DB-5



PacDrive DB-5 is the link between PS-5 and iSH. Optionally, 1 to 4 iSH motors can be connected depending on the number of drives. When operating more than 4 drives simply expand the system using one or more DB-5s.

Highlights

- 1-4 connections for iSH motors or easily expandable with more DB-5s
- Easy to expand

PacDrive Intelligent Servo Module iSH



The innovative iSH combines the motor, power amplifier, and the digital servo controller for an axis in a space-saving housing. Due to its compact construction with integrated controller it is perfectly suitable for peripheral set-up. It is available with single or multi-turn encoders and configures itself with the aid of the electronic type plate in the iSH itself.

Highlights

- compact design
- 3.5 times peak torque
- Integrated SERCOS interface
- High-resolution single or multi-turn encoder
- Protection class IP65
- simple wiring
- superior reliability

4 Indicators, control elements, diagnosis

The PacDrive™ system supports the user with its comprehensive diagnostic system.

The diagnostic messages can be read out with the Automation Toolkit **EPAS-4**. The PacDrive™ system contains a powerful message logger in which additional diagnostic information is recorded.

Diagnostic messages are usually displayed by a control panel on the machine. If an "error" occurs, read the diagnostic message on this unit and then contact the machine manufacturer.

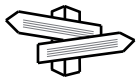

Detailed information on diagnosis is available in the Online Help of the Automation Toolkit **EPAS-4**.

4.1 Indicators and control elements

4.1.1 PacDrive Power Supply PS-5

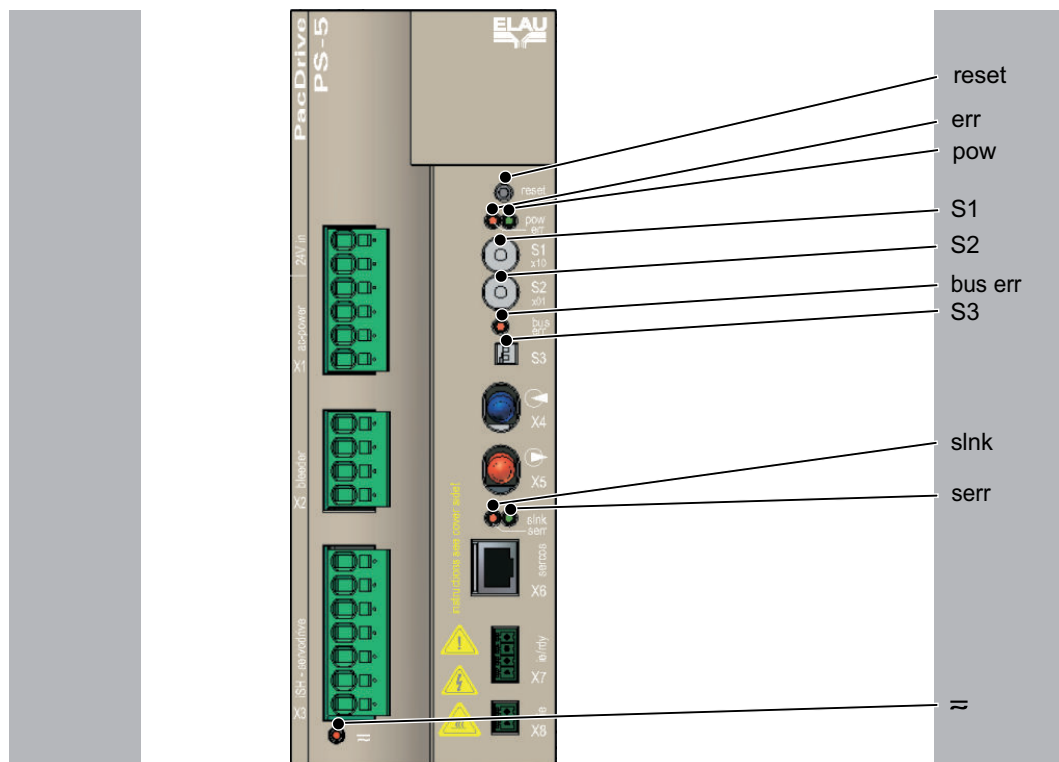

Figure 4-1: PacDrive PS-5 display elements and operating elements



pow (control voltage display)

The "pow" LED indicates the state of the control voltage.

OFF	Control voltage (24 V) is missing or is too low, not ready, fatal system error
Flashes slowly (0.5 Hz)	Bootloader is active, firmware is defective (Flashes in sync with err LED).
Flashes briefly (3 Hz, 30 ms ON)	Identifying the device (IdentifyDevice parameter) (Flashes in sync with err LED).
ON	Device ready, error diagnosis by means of PacDrive controller possible



err (error display)

The error LED (err) indicates errors.

OFF	No error
Flashes slowly (0.25 Hz)	SERCOS error
Flashes slowly (0.5 Hz)	Bootloader is active, firmware is defective (Flashes in sync with pow LED).
Flashes quickly (2 Hz)	General error or device not entered in the PLC configuration as a real device.
Flashes long Flashes for a long time (0.5 Hz, 1.8 s ON)	SERCOS ring interruption
Flashes quick Flashes briefly (3 Hz, 30 ms ON)	Identifying the device (IdentifyDevice parameter) (Flashes in sync with pow LED).
ON	Fatal system error

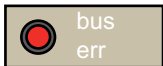

bus err (SERCOS bus error display)

The error LED (err) indicates errors.

OFF	Normal operation
ON / Flashes	Bus error (problem with fiber-optic cable connection, e.g. transmitting power is too low or too high, cable break, etc.)

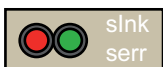

slnk (SERCOS link display)

The "slnk" LED indicates the state of the SERCOS bus (to X7 SERCOS via copper cable).

OFF	SERCOS ring break
ON	SERCOS ring OK

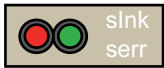

serr (SERCOS bus error display)

The "serr" LED indicates errors (for X7 SERCOS via copper cable).

OFF	Normal operation
Flashes	iSH err LED display for the directly connected iSH .
ON	<ul style="list-style-type: none"> • Error in an DB-5 connected with aiSH or bus error (connection problem, cable break, etc.) • Identification of a subordinate iSH active (parameter IdentityDevice) • No configured real (parameter RealTimeBusAdr 1 ... 99) iSH is connected to DB-5.



Residual DC bus voltage display

This LED indicates dangerous DC bus voltage.

OFF	DC bus voltage < 50 V DC
ON	Dangerous DC bus voltage >= 50 V DC.

CAUTION

Observe the safety instructions when working with Dangerous DC bus voltage.



reset button

Button for resetting the PacDrive device. Only the PacDrive **PS-5** is restarted.

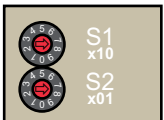

S1/S2 address setting with rotary switch

The two-digit SERCOS address (00 ... 99) must identify every SERCOS slave in the ring unambiguously.

S1	Tens position of the SERCOS address
S2	Digits position of the SERCOS address

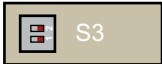

S3

S3 - fiber optic cable intensity

The transmitter intensity of the fiber-optic light source can be changed with the DIL-switch at front plate of the PacDrive PS-5. The transmitter intensity depends on how long the cable to the next slave is.





Cable length [meter]	Curr_P_Gain	switch position
0.1 - 1	1	
1.1 - 20	2	
20.1 - 40	3	
40.1 - 50	4	

Table 4-1: The transmitter intensity with assigned cable length.

4.1.2 PacDrive Distribution Box DB-5

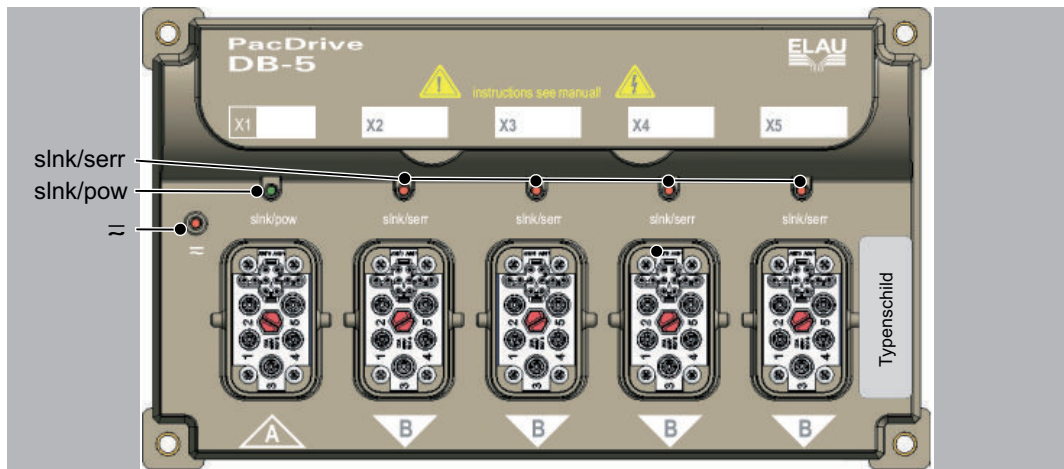

Figure 4-2: PacDrive DB-5 display elements and operating elements



Residual DC bus voltage display

This LED indicates dangerous DC bus voltage.

OFF	DC bus voltage < 50 V DC
ON	Dangerous DC bus voltage \geq 50 V DC.

CAUTION

Observe the safety instructions when working with Dangerous DC bus voltage.



slnk/pow (X1 status display)

The "state" LED indicates the state of the control voltage.

OFF	No power supply of the DB-5 (PS-5 off)
Flashes	SERCOS ring break
ON	SERCOS ring OK

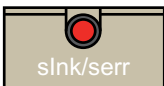

slnk/serr (X2...X5 status display)

The "state" LED indicates the state of the control voltage.

OFF	SERCOS ring break or device switched off by the IEC function Sercos-SlaveShutdownModeSet().
GREEN	SERCOS ring OK
GREEN flashes briefly (3 Hz, 30 ms ON)	Identifying the connected iSH (IdentifyDevice parameter)
RED	Error in connected DB-5 or fatal system error in connected iSH
Flashing RED	Display of the iSH err-LED

4.2 Example of a diagnostic message

2121 Bleeder Temperature Too High

Diagnostic class (standard): 2

Diagnostic code 121

Reaction: B

The bleeder is overloaded.

- The drive has incorrect dimensions.
- ▶ Check drive sizing.

- Hardware error: The braking resistor or addressing is defective.
- ▶ Contact ELAU customer service.

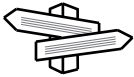

The meaning of the diagnostic code is more thoroughly explained in the online help section of the EPAS-4 automation toolkit.

5 **Transport, storage, unpacking**

5.1 **Transport**

- Avoid heavy shocks and/or vibrations during transport.
- Check the units for visible transport damage and inform the shipping company immediately if necessary.

5.2 **Storage**

- Store devices in a clean, dry room.
- The air temperature at the storage location must be between - 25 °C and + 70 °C.
- Possible temperature variations at the storage location must be maximum 30 K per hour.

5.3 **Unpacking**

- Remove the packaging.
- Check that delivery is complete.
- Check the delivered goods for transport damage.

5.4 Type Plate

ELAU

www.elau.de

Made in Germany

PS-5/...

Input 1 1AC / 3AC 220 - 480 V
10 / 20 A 48 - 62 Hz

Input 2 24 VDC
13 A

Output 1 max. 680 VDC
10 / 20 A

Output 2 24 VDC
12 A

TUV NORD
Safety Approved
SAS1736/08

CE

QC
Passed

UL LISTED
C US (IND. CONT.EQ.) 72KL

Schneider
Electric

PS-5 technical type plate

ELAU

www.elau.de

Made in Germany

DB-5/...

Input 1 max. 680 VDC
10 / 20 A

Input 2 24 VDC
12 A

Output 1 max. 680 VDC
10 / 20 A

Output 2 24 VDC
12 A

type rating enclosed type 1 rating
IP 65

TUV NORD
Safety Approved
SAS1736/08

CE

QC
Passed

UL LISTED
C US (IND. CONT.EQ.) 72KL

Schneider
Electric

DB-5 technical type plate

Label	Meaning
PS-5 / DB-5	Device type, see type key
Input 1	Rated voltage and rated current of the power supply
Input 2	Rated voltage and rated current of the electronics
Output 1	Rated voltage and rated current of the power supply
Output 2	Rated voltage and rated current of the electronics

Table 5-1: Explanation of the technical type plate

PS-5 POWER SUPPLY iSH
 13130265 HW: 232201
 833373.0010 1907 SW: 00.24.00

Made in Germany

DB-5 DISTRIBUTION BOX iSH
 13130266-001 HW: 1102
 858367.0010 1907

Made in Germany

PS-5 logistic type plate

DB-5 logistic type plate

Label PS-5	Label DB-5	Meaning
PS-5 POWER SUPPLY iSH	DB-5 DISTRIBUTION BOX iSH	Device type, see type key
13130265	13130266-001	Item no.
833373.0010 1907	858367.0010 1907	Serial Number
HW	HW	Hardware version
SW		Software version

Table 5-2: Explanation of the logistical type plates

6 Installation and maintenance

We strongly recommend that you contact ELAU personnel for initial start-up. This is not only for guarantee reasons, but also for:

- the equipment will be checked,
- the optimal configuration recorded and
- operating staff can be instructed.

6.1 Initial start-up

DANGER

**High leakage current
Risk of death**

- The leakage current is greater than 3.5 mA. This is why units require a fixed connection to the power supply network (in accordance to DIN EN 50178 - Equipping high-current electrical systems).

This is how you proceed with the commissioning:

- Testing*
- ▶ Check that delivery is complete.
 - ▶ Check device for sound condition.
Only operate undamaged devices.
 - ▶ Check data against type plates.



For further information (see 6.7 Device replacement).

- SERCOS
adress*
- ▶ Use an appropriate tool to set the predetermined SERCOS address (0-99) on the front of the motor.



Be extremely careful not to assign an address more than once in a SERCOS ring. Each drive must have its own unique SERCOS address.

- Installation*
- ▶ Observe requirements for the installation location.
 - ▶ Observe requirements for the protection class and the EMC rules.
 - ▶ Install device.



For more information about the electrical connections of the PS-5 (see 8.2.1 PacDrive Power Supply PS-5).

- PS-5
to electricity*
- ▶ Establish the connection for X1 and X2 as specified in the wiring diagram.
 - ▶ Connect prefabricated cable (**PS-5/DB-5**) to the connector X3, X6 and X8.
 - ▶ Connect **PS-5** at connectors X4 and X5 via 2 fiber optic cables to the PacDrive controller.

- DB-5** ▶ Remove the dummy plug from the X1 connector.
to electricity ▶ Remove the protective covering from the connecting cable for **PS-5/DB-5**.
 ▶ **PS-5/DB-5** connecting cable into the X1 connection.
 ▶ If another **DB-5** is connected, plug prefabricated connecting cable "**DB-5/DB-5**" into a connector X2 ... X5 and use connector X1 to connect the next **DB-5**.

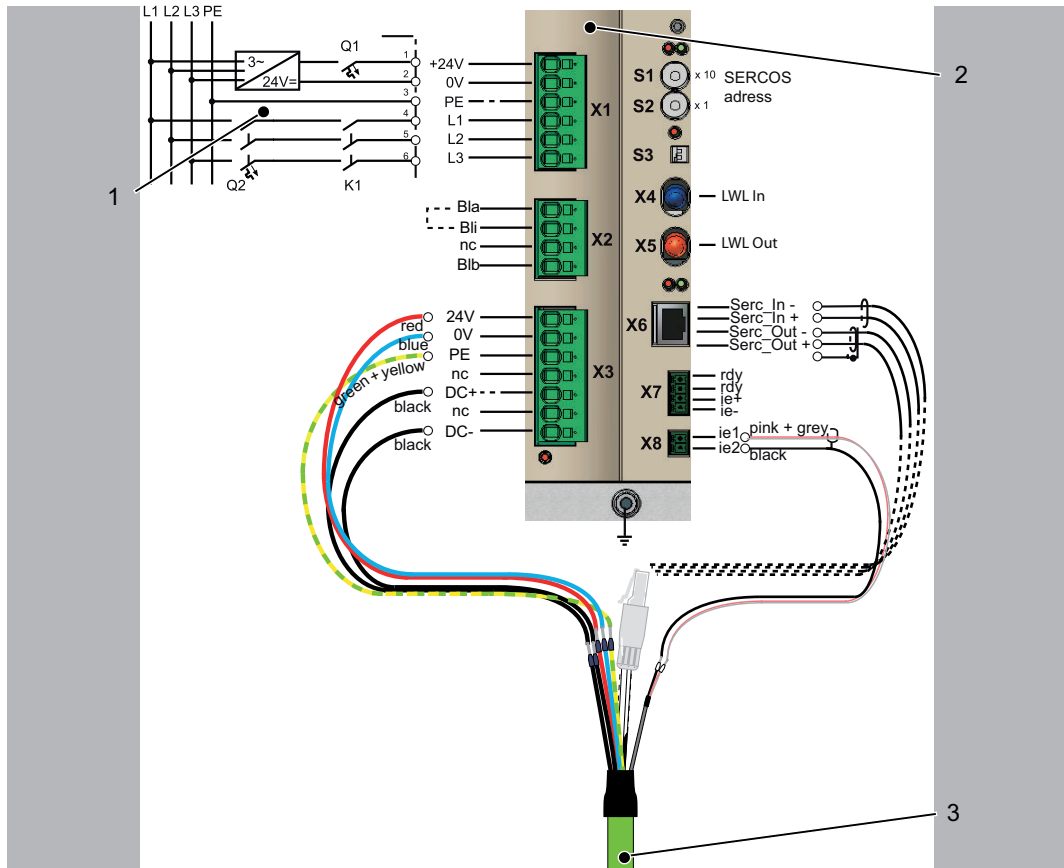

1	3-phase connecting power
2	PS-5 Front
3	Connection Cable PS-5/DB-5



For more information see Technical Data and Maintenance.

for wear & continue

- ▶ Check brake function (if present).
- ▶ Check brake function during operation at least once a year.
- ▶ Check safety functions such as EMERGENCY OFF end switch.

- ▶ Resume system operation according to the operating manual (from the packaging machine manufacturer and servo amplifier).



Information on the connection of the PacDrive iSH to the PacDrive Distribution Box **DB-5** is available in the operating manual "PacDrive Intelligent Servo Module iSH and Optional Modules".

CAUTION

Observe the following restrictions if you use ELAU copper- (motor cables, feedback cables and hybrid cables) as well as fiber optic cables. For "permanently flexible" copper and hybrid cables, observe the guidelines for dragchains.

Non-observance of the notes and instructions can lead to a defect of cables.

Restrictions	Copper cable	Hybrid cable	Fiberoptic conductor
Minimum bending radius (permanently wired cables)	3 x cable diameter	iSH: 5 x cable diameter (14,3 mm) SCL: 5 x cable diameter	20 x cable diameter *
Minimum bending radius (cables with an unrestricted range of motion)	-	iSH: 7.5 x cable diameter (14,3 mm)	-
Minimum bending radius (permanently flexible cables)	12 x cable diameter	iSH: 12 x cable diameter (14,3 mm) SCL: 7.5 x cable diameter	-- **
Permissible temperature range (fixed cables (according to DIN VDE))	-50 °C ... +90 °C	-50 °C ... +90 °C	0 °C ... 80 °C
Permissible temperature range (moved cables (according to DIN VDE))	-40 °C ... +90 °C	-40 °C ... +90 °C	-- **
Number of bending cycles	5 mn cycles ***	5 mn cycles ***	-- **

When laying fiber optic conductors, a minimum bending radius of 15 x cable diameter is allowed for a short period of time.

** Fiber-optic conductors must not be used for "permanently flexible" applications.

*** At maximum velocities of 2 m/s and maximum accelerations of 5 m/s²

Table 6-1: Properties of conductors used by ELAU



Use lower velocities and smaller bend radii to enhance service life of a cable.

6.2 Configuration, homing and programming

The PacDrive™ system is adapted to your task using the EPAS-4 automation tool-kit.

The system will be configured and programmed according to IEC 61131-3 in EPAS-4.

CAUTION

Complex functionality of PacDrive™ system and the machine

Property damage

- Program changes may only be carried out by trained personnel with detailed knowledge of the system.
- Changes may only be carried out by your machine supplier or by ELAU employees.
- ELAU AG is not liable for damages caused by unauthorized program changes.

6.3 EMC Rules

To control and regulate the motors, the mains voltage is stored by rectification in the DC bus of the servo amplifier. This stored energy is supplied to the motor by targeted switching on and off using six semiconductor switches. The steep increase/decrease in voltage places considerable demands on the dielectric strength of the motor winding. An important additional aspect to observe is the electromagnetic compatibility (EMC) with other system components. The high rate of change of the clocked voltage generates harmonics of great intensity up into the high frequency range.

CAUTION

Electromagnetic fields!

Interference or breakdown of system possible!

- Observe the following rules during installation to eliminate excessive interference effects and their consequences as much as possible.
- During installation, select the earthing option with the lowest resistance for high frequency operation (e.g. unpainted sub plate in switch cabinet).
- Ensure largest contact surface area possible (skin effect). If necessary remove any existing paint.
- Lay the grounding in a star configuration from the central earthing point to the corresponding connections. Current loops of earthing are prohibited and can cause unnecessary interference.
- Use shielded cable only.
- Ensure large shielding transitions. (Connecting shielding via PIN contacts of plug-in connectors is not permitted.)
- Observe the circuit suggestions.
- Shorten motor cable to minimum length.
- Do not lay any cable loops in the switch cabinet.
- In conjunction with electronic controllers, no inductive loads may be switched without suitable fault clearance.
- Appropriate interference suppression is achieved during direct current operation by using recovery diodes and by using protector type-based, industry-standard quenching circuits during alternating current activity.
- Only a fault clearance element placed directly at the inductivity serves the purpose. In some cases even more interference may be generated by the shock of the switching current on the interference suppression lines. It is much easier to avoid sources of interference than to eliminate the effects of existing interference.
- Contacts that do not switch suppressed inductive loads should never be arranged in a room with ELAU PacDrive components. The same applies for connection lines that do not lead suppressed, switched inductances and lines that run parallel to them. Isolate the controller from such interference sources using a Faraday cage (separately partitioned switching cabinet).
- Mains filters and motor filters may be used depending on the combination of the servo amplifier/motor and the cable length.
Refer to the project planning guide for the PacDrive™ M system.

6.4 Maintenance, repair, cleaning

Repair

Quick detection and correction of faults during machine downtime help keep production downtime to a minimum.

Proceed as follows in case of repair:

- ▶ Fill in the fault report form in the attachment (can also be sent per Fax).
- ▶ When possible, replace defective parts (see 6.7 Device replacement).

CAUTION

To avoid damage in transport and to guarantee that the repair process flows smoothly, follow the method outlined in the chapter on "Device Replacement".

- ▶ Send the defective part back to ELAU.

Cleaning

When correctly installed the the component is largely maintenance free. For removing dust that has been attracted through the cooling air flow, the ELAU component must be switched voltage free, removed and then blown-out using dried compressed air (maximum 1 bar).

6.5 Spare part inventory

Keeping a stock of the most important components is an important requirement for equipment to function constantly and be ready for operation at all times.

CAUTION

- You may only exchange units with the same hardware configuration and the same software version.

Indicate the following information on the spare part order:

Item name:	e.g. PacDrive iSH-070/60/011
Item no.:	e.g. 66012102-xxx
Hardware code:	e.g. HW: 22300301
Software version:	e.g. SW: 00.24.21



You will find this information on the type plate and in the controller configuration of the PacDrive System.

6.6 Order numbers

6.6.1 Power Supply PS-5

Order number	Item name
13 13 02 65	PacDrive Power Supply PS-5

6.6.2 Distribution Box DB-5

Order number	Item name
13 13 02 66 - 001	PacDrive Distribution Box DB-5

6.6.3 Options

Order number	Item name	Explanations
KT10659	DIO-4 M12 DISTRIBUTOR	Sensor/actuator box for iSH-DIO8
15 15 44 17	iSH-HCN1	Hybrid connector for disconnection point to connect machine modules; cable bushing at switching cabinet. See also cable E-MO-121.
13 13 02 67	iSH-DIO8	Optional I/O module
51 13 03 25	iSH-DIS1 iSH	Deactivation of Inverter Enable circuit on iSH

6.6.4 Connection cable

Order number	Item name	Explanations
15 15 45 13 - XXX	E-MO-117	Connection PS-5/DB-5 or iSH-HCN1/DB-5 (DB-5 bottom cable outlet)
15 15 45 14 - XXX	E-MO-118*)	Connection DB-5/DB-5 or DB-5/iSH (iSH left cable outlet) (DB-5 bottom cable outlet)
15 15 45 15 - XXX	E-MO-119*)	Connection DB-5/iSH (iSH right cable outlet) (DB-5 bottom cable outlet)
15 15 45 16 - XXX	E-MO-120*)	Connection DB-5/iSH (straight cable outlet iSH) (DB-5 bottom cable outlet)
15 15 45 17 - XXX	E-MO-121	Connection DB-5/iSH-HCN1 (DB-5 bottom cable outlet)
15 15 45 18 - XXX	E-MO-124*)	Connection DB-5/iSH (iSH left cable outlet) (DB-5 straight cable outlet)
15 15 45 19 - XXX	E-MO-125*)	Connection DB-5/iSH (iSH right cable outlet) (DB-5 straight cable outlet)
15 15 45 20 - XXX	E-MO-126*)	Connection DB-5/iSH (straight cable outlet iSH) (DB-5 straight cable outlet)
15 15 45 21 - XXX	E-MO-127	Connection PS-5/iSH-HNC1
KA99051-030	I/O cable M12 angled 3.0m	Connection iSH-DIO8/DIO-4 (8-pin connector with cable (open line end))

- *) - Cable lengths up to 2 m (5 m) in increments of 10 cm (50 cm)
 - The maximum length from the **PS-5** to the last **DB-5** is 20 m.
 - The maximum length from **DB-5** to the motor must not exceed 5 m!

6.7 Device replacement

CAUTION

Opening of drive!
 Faulty replacement!
 Possible damage to the drive!
 Manufacturer's warranty expired!

- Do not open drive to put it into operation or replace it.
- In addition to the following instructions, you must observe the machine manufacturer's specifications when replacing the drive.

DANGER

High voltage!
 Electric shock, fire or explosion!

- Before working on electrical equipment, always put the main switch in the "OFF" position and secure it against being switched back on.
- Make sure that the drives are at a standstill because potentially fatal voltage can occur on the motor lines in generator operation.
- Disconnect the plug-in connectors that are not live.
- Disconnect and plug in power connector cables only when the system is deactivated.
- Before working on the unit, discharge the DC bus and use a voltage meter to make sure that there is no voltage.
- If you are using prefabricated cables not manufactured by ELAU, check that the assignment of the new cables complies with the connection diagram of the machine manufacturer.

CAUTION

Electrostatic discharge!
 Damage to component possible!

- Touch circuit boards only on edges.
- Do not touch any of the circuit points or components.
- Discharge any present static charge by touching a grounded metallic surface such as a grounded housing.
- Prevent electrostatic charges; e.g., by wearing appropriate clothing.

6.7.1 PS-5

How to replace the ELAU component:

- ▶ Take preliminary measures.
- ▶ Put main switch in "OFF" position to free system of voltage.
- ▶ Prevent main switch from being switched back on.

DANGER

High voltage even after disconnecting from mains.
Electric shock, fire or explosion!

- After disconnecting from the mains, wait at least 5 minutes for the built-in capacitors to discharge.
- Measure the voltage on the DC bus to make sure it has dropped below 50 V. (The LED for residual DC bus voltage is not a safe indicator of the absence of DC bus voltage.)
- Disconnect and plug in power connector cables only when the system is deactivated.

WARNING

Hot surfaces
Risk of burns from surface temperatures up to 100 °C.

- Wear safety gloves or wait until the surface temperature has cooled to allow safe contact!
 - Attach protective cover or touch guard.
- ▶ Disconnect cables from the PS-5.
 - ▶ Remove the screws from the top and bottom of the housing.
 - ▶ Remove PacDrive PS-5.

CAUTION

Electrostatic discharge!
Potential damage to components
Warranty claim null and void

- Use the original or similar packaging to send back components.
 - Components must be packaged in ESD packaging/film.
- ▶ Install New PS-5 and tighten screws.
 - ▶ Connect PS-5 according to machine's circuit diagram.
 - ▶ Put the system back in operation.

CAUTION

Keep a logbook for recording the maintenance history of the machine and note in it the components replaced (as per IEC62061, 7.2.k) 1)).

6.7.2 DB-5

How to replace the ELAU component:

- ▶ Take preliminary measures.
- ▶ Put main switch in "OFF" position to free system of voltage.
- ▶ Prevent main switch from being switched back on.

DANGER

High voltage even after disconnecting from mains.
Electric shock, fire or explosion!

- After disconnecting from the mains, wait at least 5 minutes for the built-in capacitors to discharge.
 - Measure the voltage on the DC bus to make sure it has dropped below 50 V. (The LED for residual DC bus voltage is not a safe indicator of the absence of DC bus voltage.)
 - Disconnect and plug in power connector cables only when the system is deactivated.
- ▶ Disconnect connector on X1.
 - ▶ **iSH** Disconnect connector.
 - ▶ Replace **DB-5**.
 - ▶ **iSH** Plug in connector.
 - ▶ Plug connector into X1.

CAUTION

Keep a logbook for recording the maintenance history of the machine and note in it the components replaced (as per IEC62061, 7.2.k 1)).

6.8 Cable replacement

DANGER

High voltage!
Electric shock, fire or explosion!

- Before working on electrical equipment, always put the main switch in the "OFF" position and secure it against being switched back on.
 - Make sure that the drives are at a standstill because potentially fatal voltage can occur on the motor lines in generator operation.
 - Disconnect the plug-in connectors that are not live.
 - Disconnect and plug in power connector cables only when the system is deactivated.
 - Before working on the unit, discharge the DC bus and use a voltage meter to make sure that there is no voltage.
 - If you are using prefabricated cables not manufactured by ELAU, check that the assignment of the new cables complies with the connection diagram of the machine manufacturer.
-
- ▶ Open main switch.
 - ▶ Prevent main switch from being switched back on.
 - ▶ Disconnect / connect cables of PS-5 (see replacement of PacDrive PS-5).
 - ▶ Disconnect / connect cables of DB-5 (see replacement of PacDrive DB-5).

7 Planning

7.1 PacDrive PS-5 Mains Connection

Power supply grounding requirements

grounded PacDrive PS-5 may be operated without potential separation on AC networks with a grounded star point.

ungrounded Operating on ungrounded mains (IT networks) or mains without a grounded neutral point increases the hazard of impermissible excess voltage between external conductors and the PacDrive servo amplifier housing. For this reason, use an isolating transformer when operating on such networks. The star point on the output side as well as the PacDrive PS-5 PE connection must be grounded.

Meet UL conformity as follows:

- ▶ Use a fuse (Type: maximum 40 A, 600 VAC) in the feed line.
- ▶ Operate the power supply only on a circuit capable of delivering not more than 5000 rms symmetrical amperes.
- ▶ For 24 V supply, use a fuse with max. 15 A.

7.2 Wiring notes

Cable bushing at switching cabinet

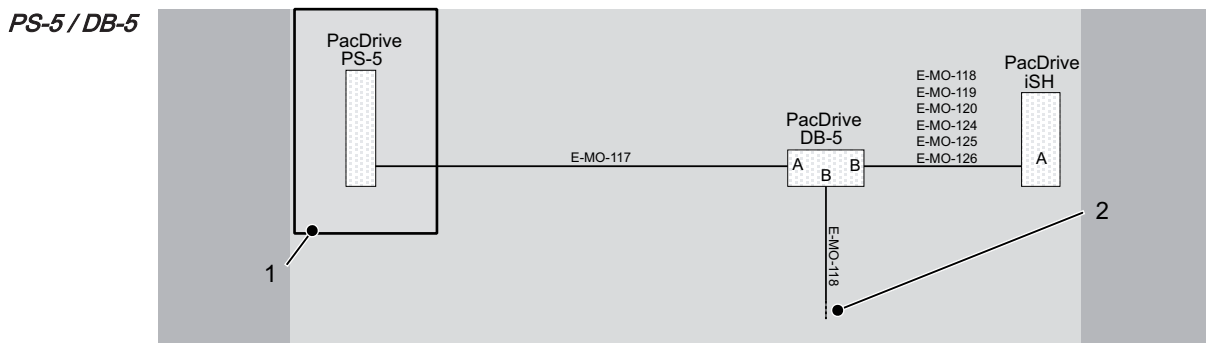

Figure 7-1: PS-5/DB-5 cable gland

1	Switch cabinet
2	Connection cable to another DB-5

DB-5 / DB-5 To enable cable bushing from DB-5 to DB-5 through a cable channel or pipe, use a iSH-HCN1 if possible. That enables you to connect the iSH-HCN1 both between PS-5 and DB-5 as well as between DB-5 and DB-5. Depending on the arrangement, different cable variations may be needed. The following figure illustrates the possible positions of the iSH-HCN1.

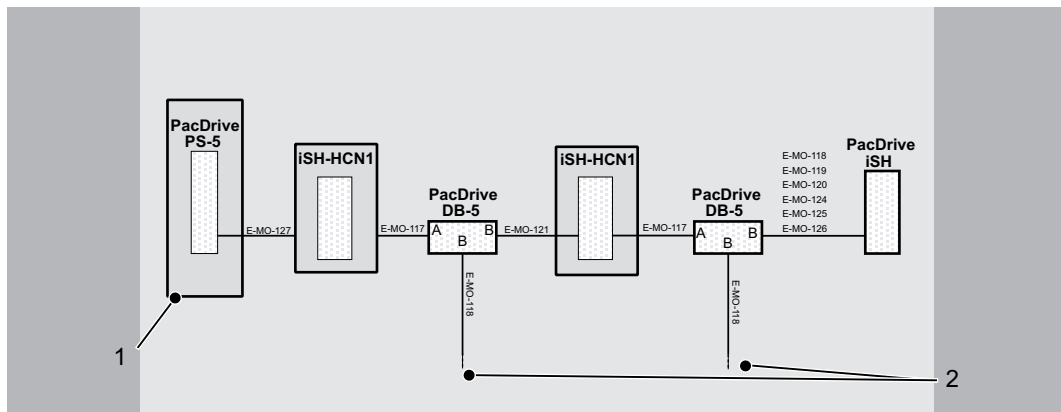

Figure 7-2: DB-5 -> DB-5 cable gland cable

1	Switch cabinet
2	Connection cable to another DB-5

CAUTION

The protection class of iSH-HCN1 is IP20.

Due to the "Inverter Enable" function, a minimum of IP54 is required.

Install iSH-HCN1 into a housing or a switching cabinet to attain a minimum of protection class IP54.



Observe the following safety instructions when wiring the iSH-HCN1.

⚠ DANGER

Incorrect wiring

Loss of Inverter Enable Function in case of misuse!

- Do not confuse ie+ and ie-.
- Check the wiring after installation.

⚠ DANGER

High voltage!

Electric shock, fire or explosion!

- Before working on electrical equipment, always put the main switch in the "OFF" position and secure it against being switched back on.
- Make sure that the drives are at a standstill because potentially fatal voltage can occur on the motor lines in generator operation.
- Disconnect the plug-in connectors that are not live.
- Disconnect and plug in power connector cables only when the system is deactivated.
- Before working on the unit, discharge the DC bus and use a voltage meter to make sure that there is no voltage.
- If you are using prefabricated cables not manufactured by ELAU, check that the assignment of the new cables complies with the connection diagram of the machine manufacturer.

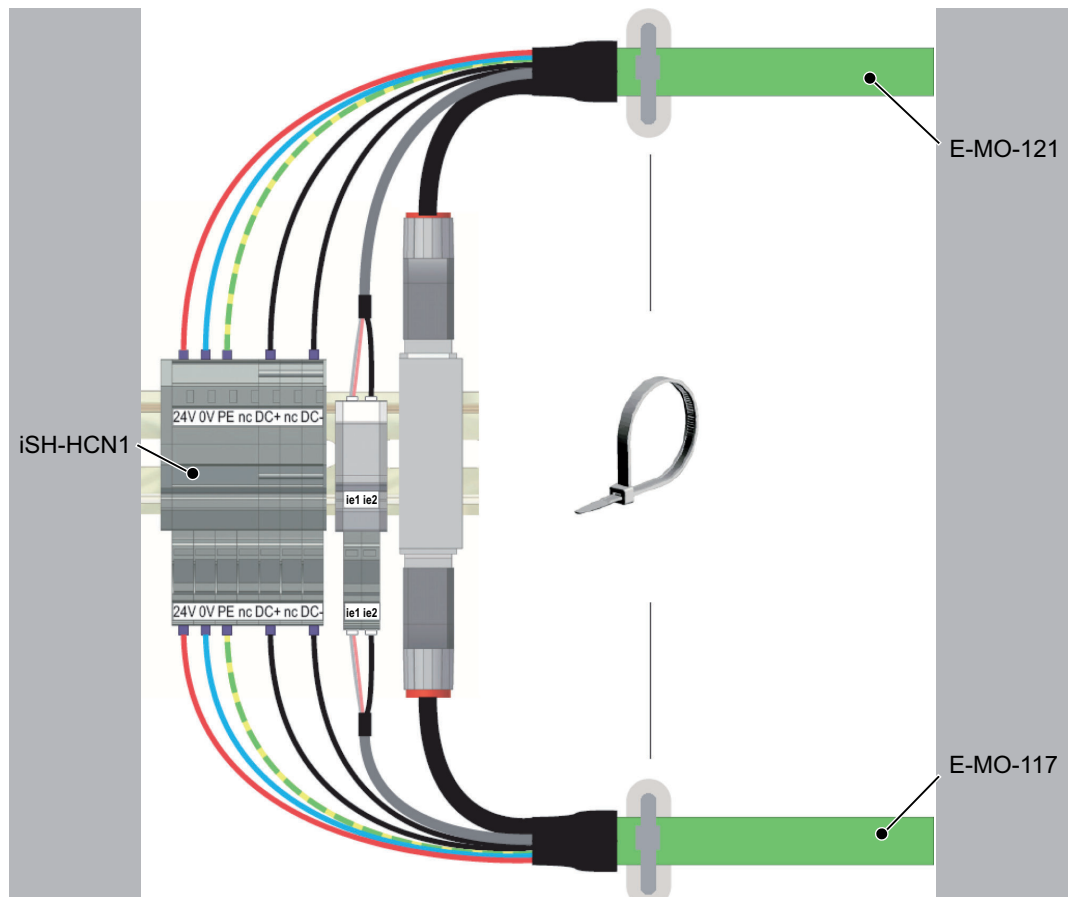

Figure 7-3: iSH-HCN1 wiring

8 Technical data

8.1 Data tables

8.1.1 PacDrive Power Supply PS-5

Parameters	Value
Item name	PS-5 POWER SUPPLY iSH
Order number	13 13 02 65
Power supply - Rated supply voltage - Rated supply voltage - Control voltage / control current	Three-phase current 3 AC / 1 AC 220 V (-10%) bis 480 V (+5%) 48 .. 62 Hz DC 24 V (-15%..+25%) / max. 13 A Own consumption max. 1A
DC circuit - DC bus voltage - Excess voltage - UBleeder ON - UBleeder OFF - Excess voltage	DC 270 V to 680 V 700 μ F DC 830 V DC 810 V DC 860 V
Bleeder (internal) - Resistance - Permanent power - Peak power	23 ohm 200 W 28 kW
Motor connection - DC bus voltage - Permanent current - DC bus peak current (1 s) - Control voltage - Permanent current - Peak current (1 s) - Number of connectable DB-5	DC 270 V to 680 V 20 A (for power supply of 3 AC...) 10 A (for power supply of 1 AC...) 40 A DC 24 V (like input voltage) 12 A 24 A max. 10
Stray power - Electronics - Power unit	25 W 15 W / A
Inputs ie + / ie - (X7) - Input voltage/current - Input filter	DC 20..30 V / 1.5 A no test pulses permitted See "Intelligent Servo Module iSH and Option Module Operating Manual"
Outputs ie1 / ie2 (X8) - Output voltage/current	AC 10..15 V _{eff} / 2 A / 100 kHz See "Intelligent Servo Module iSH and Option Module Operating Manual"
Outputs rdy (X7) - Relay outputs	DC 20..30 V / 2 A See "Intelligent Servo Module iSH and Option Module Operating Manual"

Parameters	Value
Weight	4.2 kg
Ventilation	Internal fan
Ambient conditions	
- Protection class	IP 20
- Ambient temperature during operation	+5 ...+45 °C (+55°C with reduced power -2% per K with INC and ISC)
- During storage and transport	-25 .. +70 °C
- Insulation	Degree of pollution 2, dewing not permitted
- Excess voltage category	K III, T2 (DIN VDE 0110)
- Excess voltage resistance	Class 1 (DIN VDE 0160)
- Radio interference level	Class A EN 55011 / EN 61800 - 3
- Shock	Class 3M3 (DIN EN 60068-2-27)
- Vibration	Class 3M3 (DIN EN 60068-2-6)
Approval	CE, cULus

Table 8-1: Technical data for PacDrive Power SupplyPS-5

8.1.2 PacDrive Distribution Box DB-5

Parameters	Value
Item name	DB-5 DISTRIBUTION BOX iSH
Order number	13 13 02 66 - 001
Power supply	
- DC bus voltage / DC bus current	DC 270 V to 680 V / 20 A
- Control voltage / control current	DC 24 V (-15%..+25%) / max 12 A
- Control voltage with brakes	DC 24 V (-10%..+6%)
Weight	0.85 kg
Ventilation	Natural convection
Ambient conditions	
- Protection class	IP 65
- Ambient temperature during operation	+5 ..+40 °C
- During storage and transport	-25 .. +70 °C
- Insulation	Degree of pollution 2, dewing not permitted
- Excess voltage category	K III, T2 (DIN VDE 0110)
- Excess voltage resistance	Class 1 (DIN VDE 0160)
- Radio interference level	Class A EN 55011 / EN 61800 - 3
- Shock	Class 3M6 (DIN EN 60068-2-27)
- Vibration	Class 3M6 (DIN EN 60068-2-6)
Approval	CE, cULus

Table 8-2: Technical data for PacDrive Distribution Box DB-5

8.2 Electrical connections

8.2.1 PacDrive Power Supply PS-5

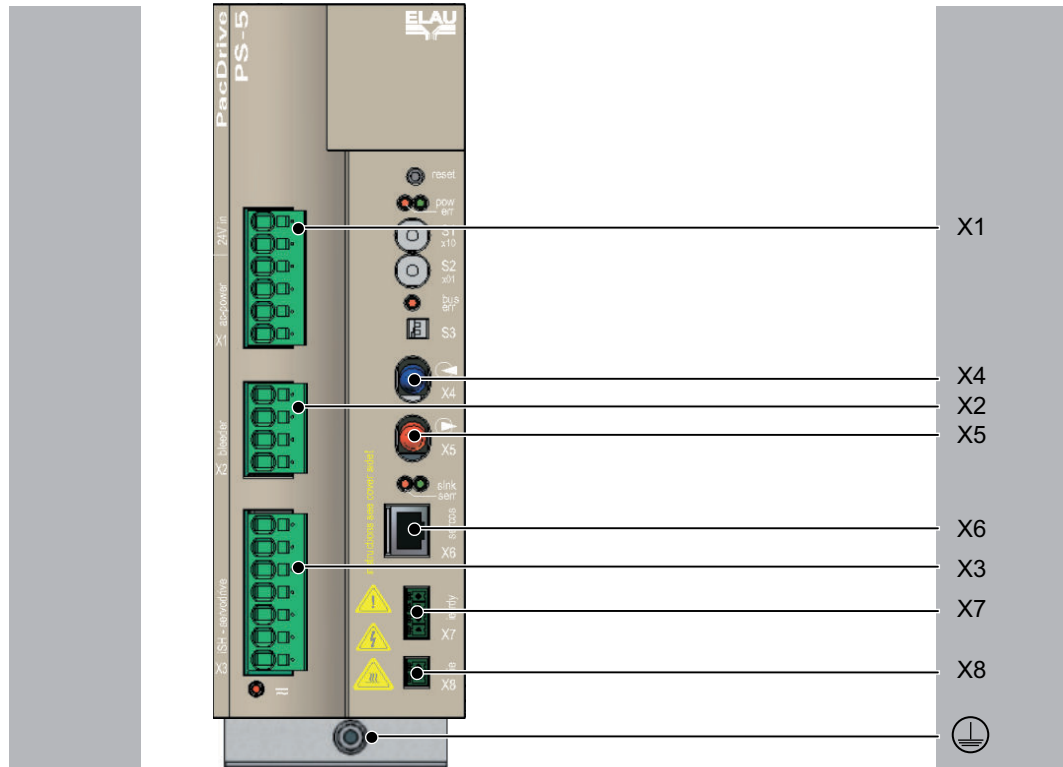

Connection	Meaning	max. terminal cross-section [mm ²]/ [AWG]		max. tightening torque [Nm]
X1	Control voltage/ Mains connection	rigid: 0.2 - 10 mm ² flexible: 0.2 - 6 mm ²	24 - 8	-
X2	Bleeder	rigid: 0.2 - 10 mm ² flexible: 0.2 - 6 mm ²	24 - 8	-
X3	iSH connection	rigid: 0.2 - 10 mm ² flexible: 0.2 - 6 mm ²	24 - 8	-
X4	SERCOS LWL IN	-	-	0.8 Nm
X5	SERCOS LWL OUT	-	-	0.8 Nm
X6	SERCOS Connection	-	-	-
X7	Control signals	rigid: 0.14 - 1.5 mm ² flexible: 0.14 - 1.5 mm ²	28 - 16	-
X8	Control signals	rigid: 0.14 - 1.5 mm ² flexible: 0.14 - 1.5 mm ²	28 - 16	-
⊥	Shielded connector	-	-	1 Nm

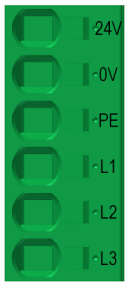

Pin	Designation	Meaning
1	24 V	Control voltage
2	0 V	Control voltage
3	PE	Ground conductor
4	L1	Mains supply
5	L2	Mains supply
6	L3	Mains supply

Table 8-3: X1 - Control voltage and mains connection

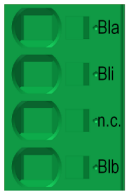

Pin	Designation	Meaning
1	Bla	Bleeder A (external)
2	Bli	Internal bleeder
3	n.c.	not connected
4	Blb	Bleeder B (external)

Table 8-4: X2 - Bleeder connection (brake resistor)

CAUTION

Excess voltage in DC bus due to wiring error!

Non-observance of the notes and instructions can lead to a defect in the device.

- A bleeder must always be connected to the PS-5.
- The internal bleeder is addressed by means of a jumper from Pin 1 "Bleeder A" to Pin 2 "Internal bleeder".
- An external bleeder is connected to Pin 1 "Bleeder A" and Pin 4 "Bleeder B".
- Remove jumper from Pin 1 to Pin 2 for the internal brake resistor if you connect an external brake resistor.



Pin	Designation	Meaning
1	24 V	Control voltage
2	0 V	Control voltage
3	PE	Ground conductor
4	n.c.	not connected
5	DC +	DC circuit +
6	n.c.	not connected
7	DC-	DC circuit -

Table 8-5: X3 - iSH connection

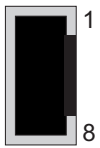

Pin	Designation	Meaning
1	SERC_OUT +	SERCOS Out +
2	SERC_OUT -	SERCOS Out -
3	SERC_IN +	SERCOS In +
4	nc	not connected
5	nc	not connected
6	SERC_IN -	SERCOS In -
7	nc	not connected
8	nc	not connected

Table 8-6: X6 - SERCOS connection

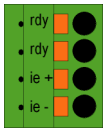

Pin	Designation	Meaning
1	rdy	Ready
2	rdy	Ready
3	ie +	Inverter Enable for 24 V supply
4	ie -	Inverter Enable for 0 V supply

Table 8-7: X7 - Inputs / outputs



Pin	Designation	Meaning
1	ie1	Inverter Enable
2	ie2	Inverter Enable

Table 8-8: X8 - Inverter Enable outputs

CAUTION

Wiring error

The PacDrive iSH may be damaged!

- Only connect the ie1/ie2 signal of the hybrid cable to the AC voltage ie1/ie2 on PS-5 connector X8.

8.2.2 PacDrive Distribution Box DB-5

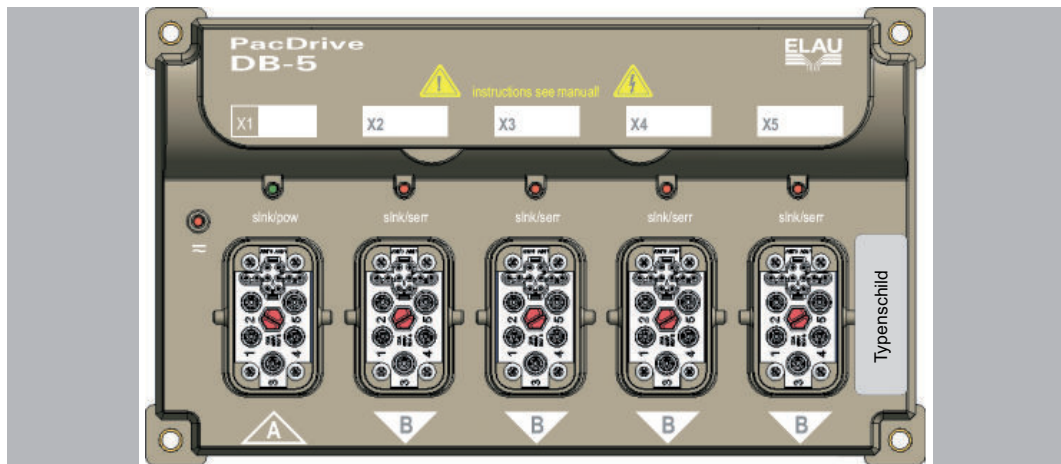

Connection	Meaning	max. terminal cross-section [mm ²]/ [AWG]
X1	Input (PS-5 or DB-5)	pre-fabricated ELAU cable
X2	Output (DB-5 or iSH)	pre-fabricated ELAU cable
X3	Output (DB-5 or iSH)	pre-fabricated ELAU cable
X4	Output (DB-5 or iSH)	pre-fabricated ELAU cable
X5	Output (DB-5 or iSH)	pre-fabricated ELAU cable

Table 8-9: Connection overview *PacDrive Distribution Box DB-5*

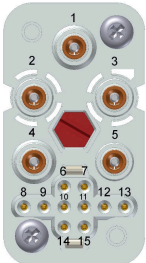

Pin	Designation A	Designation B	Meaning
3	PE	PE	Ground conductor
4	DC-	DC-	DC circuit -
1	DC +	DC +	DC circuit +
5	0 V	0 V	Control voltage
2	24 V	24 V	Control voltage
16	SERC_OUT +	SERC_IN +	SERCOS input / output
13	SERC_OUT -	SERC_IN -	SERCOS input / output
20	ie1	ie1	Inverter Enable
19	ie2	ie2	Inverter Enable
17	SERC_OUT_S	SERC_IN_S	SERCOS shield
14	SERC_IN_S	SERC_OUT_S	SERCOS shield
12	-	-	not connected
11	-	-	not connected
18	SERC_IN +	SERC_OUT +	SERCOS input / output
15	SERC_IN -	SERC_OUT -	SERCOS input / output

Table 8-10: *PacDrive DB-5 connectors*

CAUTION

Always use the supplied covers for unused connections as protection against dangerous voltages and to guarantee protection class IP 65.

8.3 Dimensions

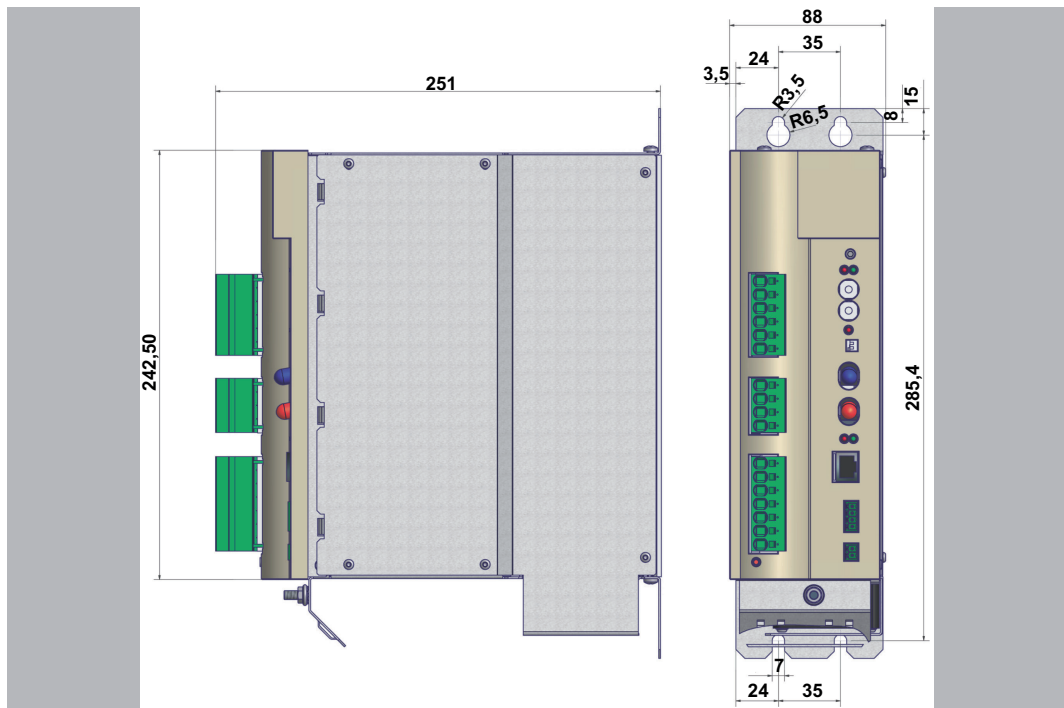

Figure 8-1: Dimensions of the PacDrive Power Supply PS-5

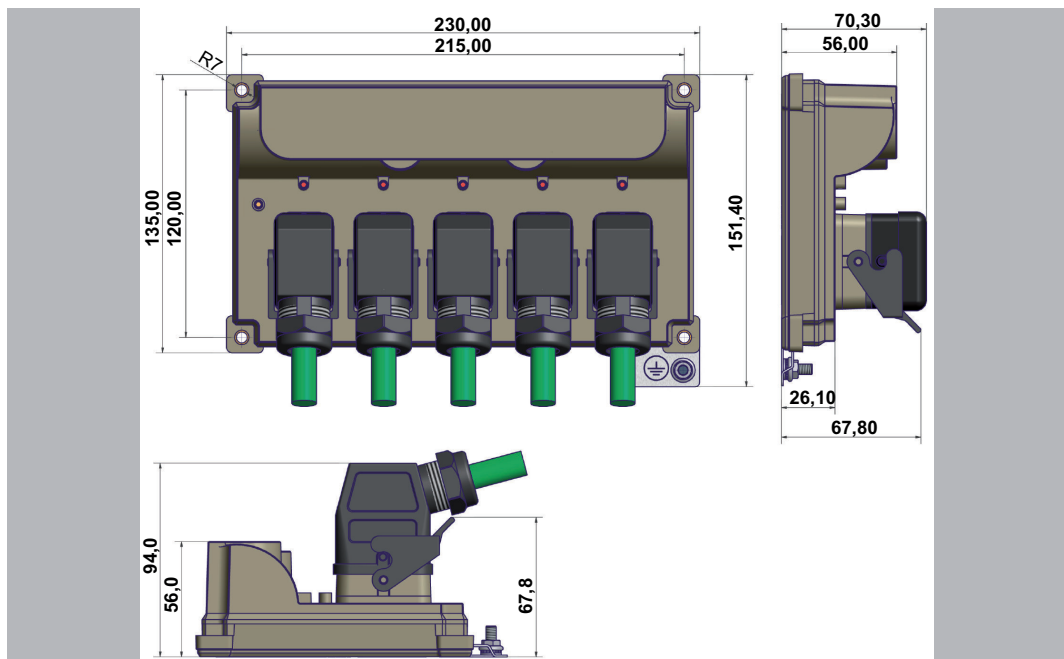

Figure 8-2: Dimensions of the PacDrive DB-5 Distribution Box

9 Hybrid Connector iSH-HCN1

To enable cable gland between a **DB-5** in the switching cabinet and a **DB-5** outside of the switching cabinet by using a cable channel or pipe, **iSH-HCN1** is required.

9.1 Technical data

Parameters	Value
Item name	iSH-HCN1
Order number	15 15 44 17
Control voltage (24 V/0 V)	
- Control voltage	DC 24 V
- Permanent current	12 A
- Peak current (1 s)	24 A
DC bus (DC+ / DC-)	
- DC bus voltage	DC 270 V to 680 V
- Permanent current	20 A
- DC bus peak current (1 s)	40 A
Inverter Enable (ie1 / ie2)	
- Voltage	AC 10..15 V eff
- Current	2 A
Weight	0.1 kg
Ambient conditions	
- Protection class	IP 20
- Ambient temperature during operation	+5 to +45 °C (+55 °C during reduced power -2% per K for INC and ISC)
- During storage and transport	-25 .. +70 °C
- Insulation	Degree of pollution 2 ..., dewing not permitted

Table 9-1: Technical data for iSH-HCN1

9.2 Electrical connections

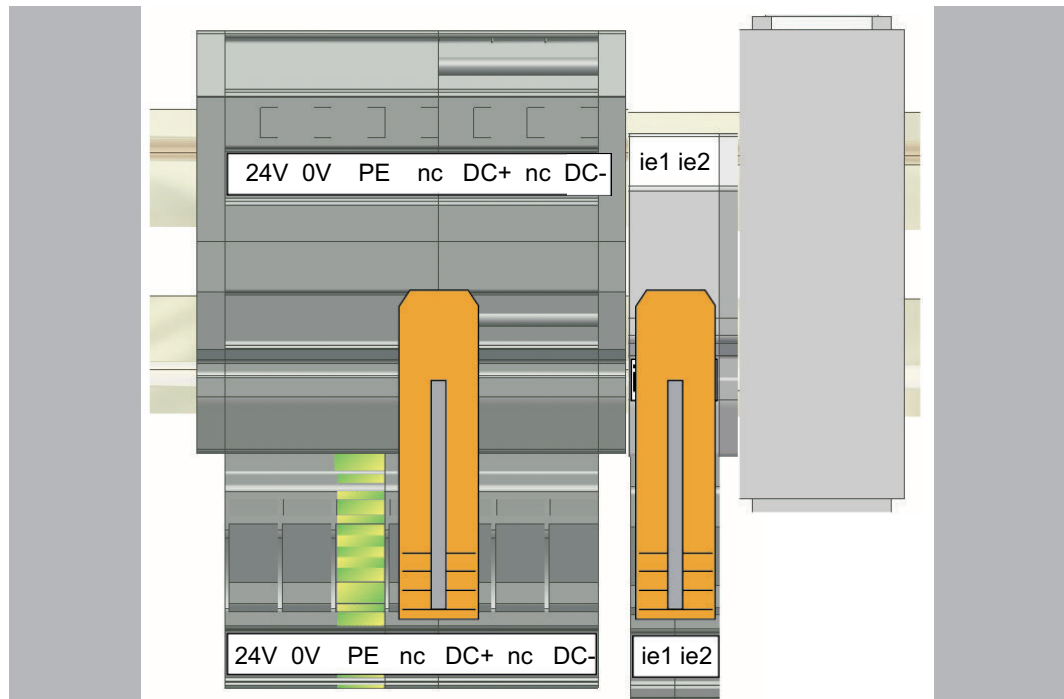

Figure 9-1: iSH - HCN1- Electrical connections



The DIN rail is not part of the iSH-HCN1.

Designation	Meaning	Color	Cross-section
24 V	Control voltage	red	2.5 mm ²
0 V	Control voltage	blue	2.5 mm ²
PE	Ground conductor	green/yellow	2.5 mm ²
nc	not connected		
DC +	DC circuit +	black "DC+"	2.5 mm ²
nc	not connected		
DC-	DC circuit -	black "DC-"	2.5 mm ²
ie1	Inverter Enable for 24 V supply	grey+ pink	0.25 mm ²
ie2	Inverter Enable for 0 V supply	black	0.25 mm ²

Table 9-2: Connections to iSH-HCN1

9.3 Dimensions

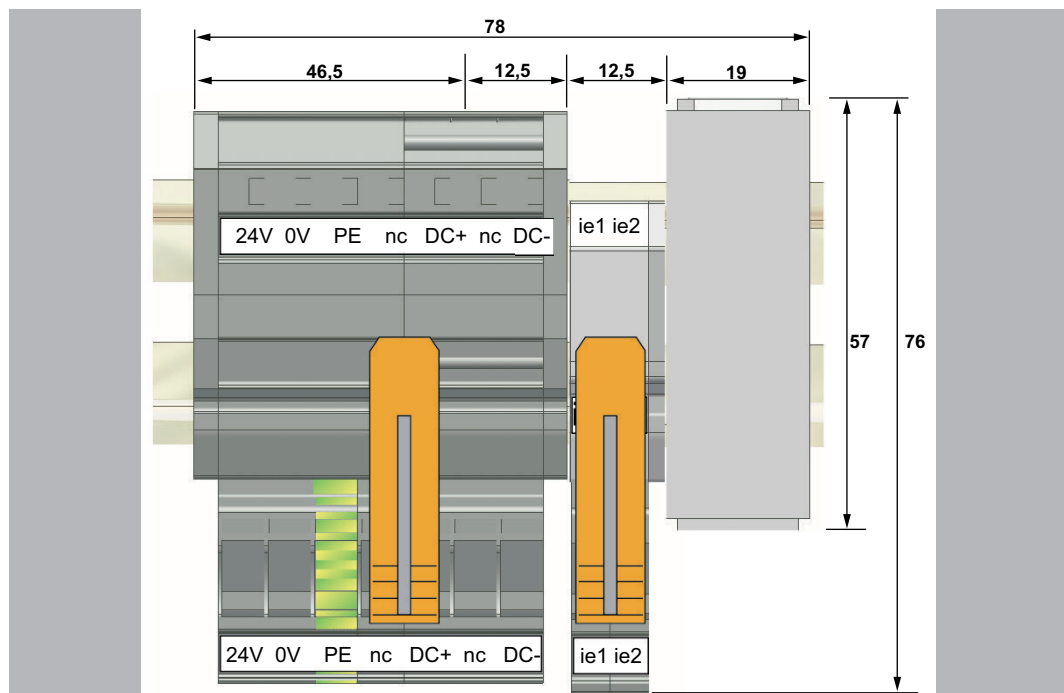

Figure 9-2: iSH-HCN1 dimension diagram

10 Appendix

10.1 Contact addresses

ELAU AG Deutschland

Dillberg 12
97828 Marktheidenfeld, Germany
Tel.: +49 (0) 9391 / 606 - 0
Fax: 09391/606-300
E-mail: info@elau.de
Internet: www.elau.de

ELAU AG Customer Service

Post office box 1255
97821 Marktheidenfeld, Germany
Tel.: +49 (0) 9391 / 606 - 142
Fax: +49 (0) 9391 / 606 - 340
E-mail: info@elau.de
Internet: www.elau.de

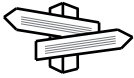

See the ELAU homepage (www.elau.de) for additional contact addresses.

10.2 Product training courses

We also offer a number of training courses about our products.

Our seminar leaders with several years of experience will help you take advantage of the extensive possibilities offered by the PacDrive™ system.



See the ELAU homepage (www.elau.de) for further information and our current seminar schedule.

10.3 Changes

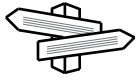

The latest product documentation, application notes and the change service are always available on the ELAU homepage.

11/2007

- New edition of the operating manual

07/2008

- Restructuring of documentation
- Revising the manufacturer's declaration
- Update of technical type plate
- Revising of the graphics
- Specification of bend cycles and bend radii of cables
- Update new connection cable

10.4 Fault report form

This fault report is required without fail to enable efficient processing.

Send the fault report to your ELAU AG-representative or to:

ELAU AG
 Customer Service Department
 Dillberg 12
 97828 Marktheidenfeld
Fax: +49 (0) 93 91 / 606 - 340

Return address:

Company:	City:	Date:
Department:	Name:	Tel.:

Specifications regarding product in question

Item name:

Item no.:

Serial number:

Software version:

Hardware code:

Parameters included Yes No

IEC - Program included: Yes No

Information about machine on which the error occurred:

Machine manufacturer:

Type:

Operating hours:

Machine no.:

Date of commissioning:

Manufacturer / Type of machine control:

.....

How did the error present:

.....

.....

.....

Additional information:

Condition of error:
 is always available

Causes:
 unknown

Accompanying side effects:
 problems in the mechanism

Index

C

Changes 51
Cleaning 30
Configuration 28
Contact addresses 50

D

Diagnosis 16
Dragchains 27

E

EMC Rules 29
Error Number 21

F

Fiber-optic conductors 27

H

Homepage 2, 50
Hybrid cable 27

I

Imprint 2

M

Maintenance 30
Minimum bending radius 27

P

Proper use 9

Q

Qualification of personnel 10

R

Risk classification 7

S

Seminars 50
Service addresses 50
Storage 22
Symbols 7

T

Technical data 41
Trademark 2
Training courses 50