



ACS 6000
Medium Voltage Drives

3 to 27 MVA

Service and Maintenance Manual

Document No.: 3BHS202077 ZAB E01 Rev. C

Issued: 21-01-2005

ABB reserves all rights to this document, also in the event of patent issue or registration of any other industrial property protection right. Misuse, in particular duplication and forwarding to third parties, is not permitted.

This document has been checked with due care and attention. However, should the user find any errors, these should be reported to ABB.

ABB aims to maintain the most modern standard, therefore, entries in this manual may differ from the actual product.

Chapter 1 - Introduction and Safety	1-1
1.1 Introduction	1-1
1.2 Safety	1-1
Chapter 2 - Checking IGCTs and Diodes	2-1
2.1 Safety	2-1
2.2 Checking IGCTs	2-1
2.2.1 Required Tools and Accessories	2-1
2.2.2 Test Procedure	2-1
Step 1	2-1
Step 2	2-2
2.3 Checking Diodes in 7/ 9 MVA Phase Modules	2-4
Chapter 3 - Changing Diodes and Thyristors in LSU	3-1
3.1 Required Tools and Accessories	3-1
3.2 Safety	3-2
3.3 Replacing Diodes and Thyristors	3-3
Chapter 4 - Changing 3/5 MVA Phase Modules	4-1
4.1 Required Tools and Accessories	4-1
4.2 Removing a Phase Module	4-2
Using the Hoist	4-6
Using a Crane	4-7
4.3 Installing a Phase Module	4-8
Chapter 5 - Changing RC-IGCTs in 3/5 MVA Phase Modules	5-1
Chapter 6 - Changing Clamp Diodes in 3/5 MVA Phase Modules	6-1
6.1 Required Tools and Accessories	6-1
6.2 Changing Procedure	6-1

Chapter 7 - Changing 7/9 MVA Phase Modules **7-1**

7.1	Required Tools and Accessories	7-1
7.2	Removing a Phase Module	7-2
7.3	Installing a Phase Module	7-5

Chapter 8 - Changing Diodes and IGCTs in 7/9 MVA Phase Modules **8-1**

8.1	Required Tools and Accessories	8-1
8.2	Overview	8-2
8.3	Safety	8-4
8.4	Replacing Clamp and NP Diodes	8-5
8.4.1	Preparatory Steps	8-5
8.4.2	Replacing Clamp Diodes	8-8
	Upper Clamp Diode	8-8
	Lower Clamp Diode	8-9
8.4.3	Replacing NP Diodes	8-11
	Removing Upper NP Diode	8-11
	Removing Lower NP Diode	8-12
	Assembling the Stack	8-12
8.4.4	Finishing Steps	8-13
8.5	Replacing Free Wheeling Diodes	8-14
8.6	Replacing IGCTs	8-16

Chapter 9 - Changing Thyristors in EXU **9-1**

9.1	Required Tools and Accessories	9-1
9.2	Safety	9-1
9.3	Replacing Thyristors in EXUs for Brushless Excitation	9-2
9.3.1	Preparatory Steps	9-2
9.3.2	Treating a New Thyristor before Installation	9-3
9.3.3	Mounting a New Thyristor	9-3
9.4	Replacing Thyristors in EXUs for Direct Excitation	9-5
9.4.1	Preparatory Steps	9-5
9.4.2	Treating a New Thyristor before Installation	9-6
9.4.3	Mounting a New Thyristor	9-6
9.5	Deflection Diagram	9-7

Chapter 10 - Changing Semiconductors in VLU **10-1**

10.1	Required Tools and Accessories	10-1
10.2	Safety	10-1
10.3	Replacing the Semiconductors	10-2

10.3.1	Preperatory Steps	10-2
10.3.2	Replacing Upper Diode	10-2
10.3.3	Replacing IGCTs	10-3
10.3.4	Replacing Lower Diode	10-5
10.3.5	Finishing Steps	10-5

Chapter 11 - Changing IGCTs in DIU **11-1**

11.1	Required Tools and Accessories	11-1
11.2	Safety	11-1
11.3	Removing an IGCT	11-2
11.4	Installing an IGCT	11-5

Chapter 12 - Replacing Printed Circuit Boards **12-1**

12.1	Safety	12-1
12.2	Replacing an AMC3 Board	12-2
12.3	Changing the AMC3 Flash Memory	12-4
12.4	Replacing an INT Board	12-7
	Transferring the EPLD Chips	12-10
	Transferring the Pulse Pattern Flash	12-10
12.5	Replacing a CVMI Board	12-12

Chapter 13 - Function of LEDs **13-1**

13.1	AMC Board	13-1
13.2	INT Board	13-3
13.3	GUSP	13-5
13.4	IGCT	13-6

Chapter 14 - Tightening Torques and Threaded Connections **14-1**

14.1	Water Cooling Unit	14-1
14.1.1	Tightening Torque for Pipe Coupling (WCU Type 29 and 52)	14-1
14.1.2	Tightening Torque for Pumps (WCU Type 29 and 52)	14-1
14.1.3	Tightening Torque for Flanges (WCU Types 29, 52, 80, 106, 120)	14-3
14.2	Pipe Joints and Busbar Connections	14-3

Chapter 1 - Introduction and Safety

1.1 Introduction

The manual must be thoroughly read and understood before maintenance work on the ACS 6000 is started.

The manual is addressed to qualified persons who are responsible for maintaining and servicing the ACS 6000. Hence all general and safety instructions given in the ACS 6000 User's Manual must be complied with.

1.2 Safety



Danger: The ACS 6000 is a high voltage device.

High voltage can cause physical injury and death.

Maintenance, parts replacement and other work on the ACS 6000 must only be carried out by qualified personnel in compliance with local regulations.



Danger: Do not access the ACS 6000 or work on the motor or the power cables, if the drive system is energized and not properly grounded!

After switching off the mains and after the motor has come to a stop, wait approximately 5 minutes for the DC link capacitors to discharge. The light **GND.- SWITCH UNLOCKED** must be on before grounding the ACS 6000.



Danger: Make sure that the main power cannot be applied by accident.

Rack out the main circuit breaker and lock it.



Danger: Some loads can cause the motor to rotate!

Therefore, always disconnect, short-circuit or block the motor before work is started.



Danger: Before power is applied to the drive, check that:

- Mains and motor connections are ok
 - Auxiliary power and control cable connections are ok
 - No tools or other foreign objects are left in the cabinet
 - All doors including the door of the power cable section are closed
-

Chapter 2 - Checking IGCTs and Diodes

2.1 Safety

IGCTs and diodes of phase modules can only be tested after the converter has been deenergized and grounded.



Danger: The ACS 6000 is a high voltage device.

Make sure that the drive has been completely deenergized and that power cannot be applied by accident.

Failure to do so may result in injury or death.

2.2 Checking IGCTs

2.2.1 Required Tools and Accessories

To test IGCTs the following is needed:

- Fiber optic cable (approx. 2 m long)
- Multimeter

2.2.2 Test Procedure

The IGCT to be tested can stay in the phase module. The test is carried out in two steps:

- Step 1*
- 1 Deenergize and ground the ACS 6000 but leave the power supply for the gate units on.
 - 2 Check the IGCT for burned components. In this case the whole IGCT must be replaced. Check that both LEDs are on. See *Figure 2-1* (*Figure 2-1* depicts the horizontal fitting position of IGCTs as applied in 7/9 MVA phase modules).

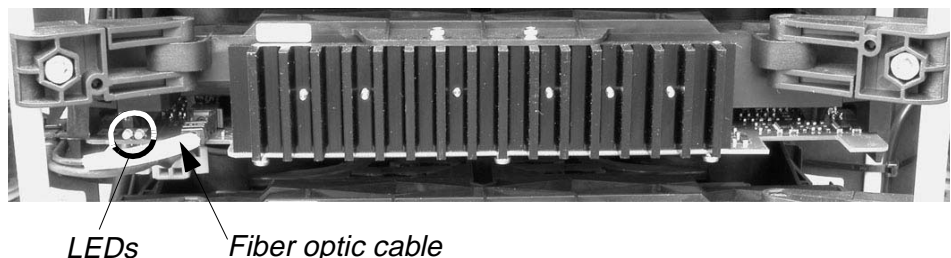

Figure 2-1 IGCT



Note: When checking be careful not to disconnect the fiber optic cable while the IGCT is energized to prevent an undefined control state.

3 Test the IGCT by measuring the voltage between gate and cathode.



Note: When measuring be careful not to shorten gate and cathode/anode of the IGCT. A short circuit will destroy the semiconductor.

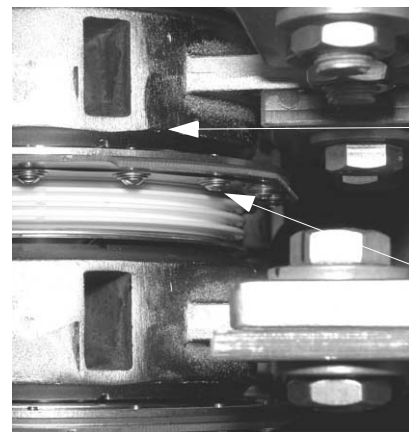

Side view

Cathode

Gate

Measuring results:

Step 1: -20 VDC

Step 2: +0.7 VDC

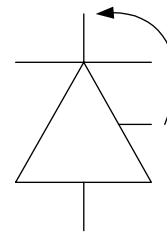

Figure 2-2 Testing IGCTs

To avoid shortening gate and cathode:

- Use short tipped probes
- Hold one probe against the cooler on the cathode side and the other probe against a screw head on the gate side (see *Figure 2-2*).

Result of the measurement: approx. -20 VDC (see *Figure 2-2*).

- 4** Disconnect the power supply of the gate unit (one of the following circuit breakers in COU: -Q1041, -Q1042, -Q1043, see wiring diagram).
- 5** Wait approx. 20 sec. for the capacitors of the gate unit to discharge.

- Step 2**
- 1** Verify that the power supply of the gate unit is off.
 - 2** Switch off the auxiliary power supply pertaining to the INT board in the cabinet.
 - 3** Connect a temporary fiber optic cable at one end to the gate unit and at the other end to a permanent light transmitter of the INT board.
 - Inside ARU: connector A714 (see *Figure 2-3*)
 - Inside INU: connector A712 or A713 (see *Figure 2-3*)

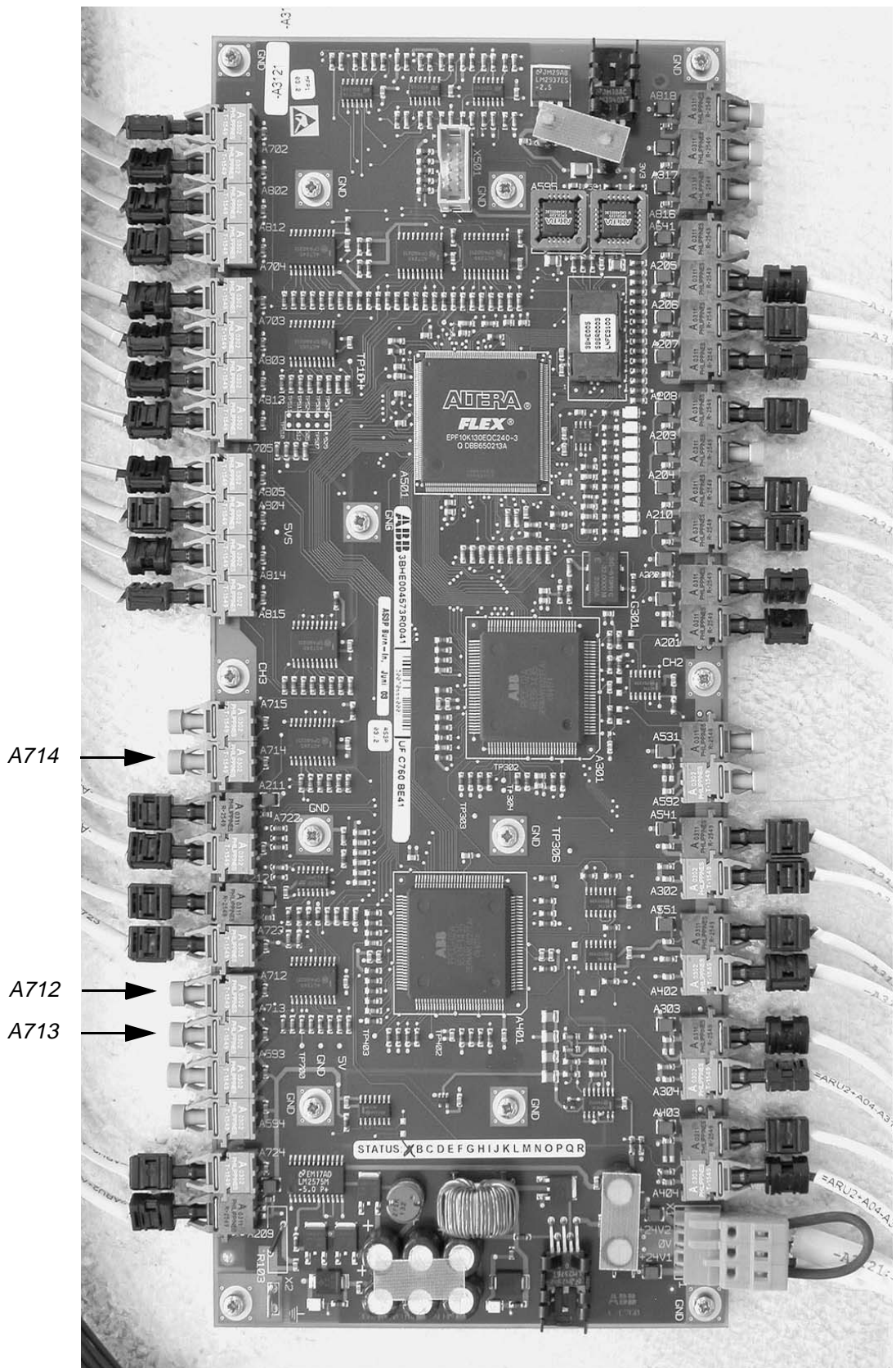

Figure 2-3 INT Board

- 4 Switch on the auxiliary power to the gate unit.
- 5 Switch on the power supply of the INT board to apply a constant light to the IGBT.
- 6 Measure the voltage between gate and cathode.
Expected result of the measurement: approx. +0.7 VDC (see also *Figure 2-2*).



Note: It is important that the following steps 5 and 6 are carried out in the stated sequence to prevent damage of the gate unit.

- 7 Disconnect the auxiliary power.
- 8 Disconnect the temporary fiber optic cable.
- 9 Reconnect the original fiber optic cable.
- 10 Switch on the auxiliary power supply.
- 11 Wait approx. 20 sec until both LEDs on the gate unit have lighted up.

2.3 Checking Diodes in 7/ 9 MVA Phase Modules

To test a diode the phase module needs to be disconnected from the busbar connectors. Water hoses, optical fibers and gate unit power supply leads can stay in place. The diodes can be accessed from the front of the phase module.

- 1 Deenergize and ground the ACS 6000.
- 2 Switch off the auxiliary power supply.
- 3 Remove the two fastening bolts at the bottom on each side of the phase module.
- 4 Disconnect the phase module from the rear busbar connectors. Pull it towards the front of the cabinet until the lower water hose just touches the support frame (see circle in *Figure 2-4*).
- 5 Check that the phase module is completely disconnected from the busbar connectors.



Note: When pulling out the phase module take care that fiber optic cables and gate unit supply leads are not damaged.

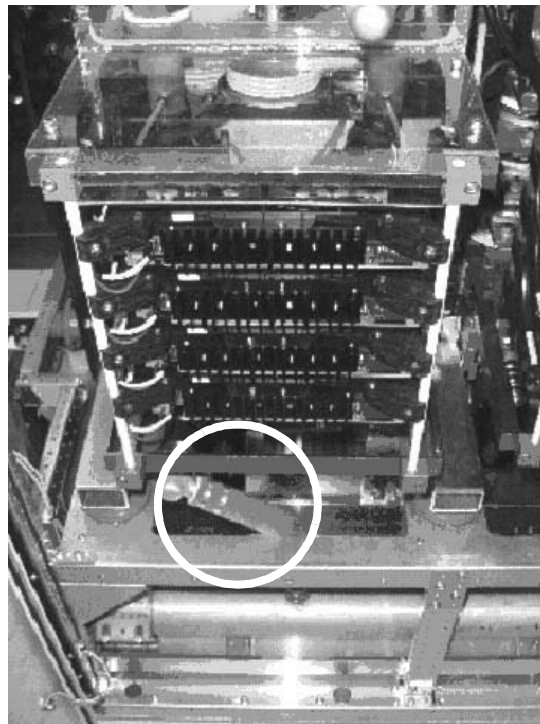

Figure 2-4 Extracting the Phase Module

- 6 Check the diode using the multimeter in diode verification mode and suitable probes.

Expected result of the measurement:

Table 2-1 Voltage Measurement

<i>Diode</i>	<i>Voltage between Anode/Cathode</i>	<i>Voltage between Cathode/Anode</i>
VR1, VR4, VC1, VC2	~ 0.2.....0.3 V	out of range (diode is blocking)
VR2, VR3, VN1, VN2	~ 0.2.....0.3 V	~ 2.2.....2.3 V

If uncertain, verify the result by checking another diode of the same phase module or of another phase module.



Chapter 3 - Changing Diodes and Thyristors in LSU

3.1 Required Tools and Accessories

The tools listed below are part of the tool set (ident. no. 3BHS130246) delivered with the ACS 6000.

- Spreader tool



Figure 3-1 Spreader Tool

- ½ " reversible ratchet
- 100 mm ½ " extension bar
- 13 mm ½" hex socket
- Clamp pressure loading spanner
- Cable ties

3.2 Safety

- 1 Deenergize and ground the ACS 6000.
- 2 Stop the cooling water pumps and make sure that they cannot be switched on by accident.



Danger: The ACS 6000 is a high voltage device.

Make sure that the cabinet has been completely deenergized and that power cannot be applied by accident.

Failure to do so may result in injury or death.



Note: After switching off the mains and after the motor has come to a stop, allow the DC link capacitors to discharge. The light **GND.- SWITCH UNLOCKED** must be on, before grounding the ACS 6000.

- 3 Switch off the auxiliary power. Refer to the wiring diagram to identify the circuit breaker.

3.3 Replacing Diodes and Thyristors

The replacement of diodes and thyristors is explained using the example of a 9 MVA LSU.



Note: When replacing diodes or thyristors of the rectifier, the clamping pressure of the stack must be released. Do not to release the pressure all at once, as otherwise all semiconductors in the stack will become misaligned. They must then be recentered in a time consuming procedure. The misalignment results from the flexible busbar connectors at the rear of the stack, which push the coolers to which they are connected to the front, thus misaligning the semiconductors. It is therefore highly recommended that the instructions below are followed.

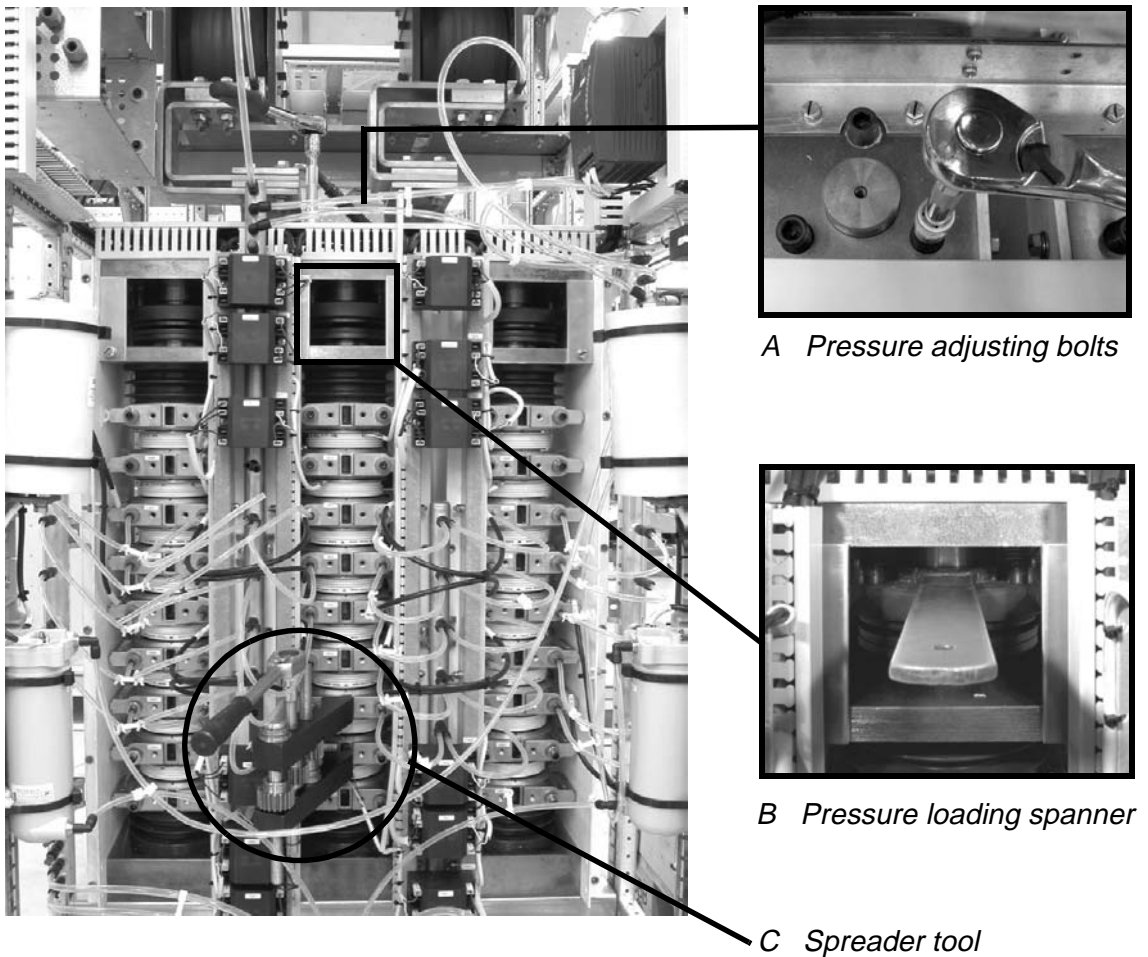

Figure 3-2 LSU Rectifier

- 1 Deenergize the drive. See section 3.2 *Safety*.
- 2 Insert the clamp pressure loading spanner (see B in *Figure 3-2*).
- 3 Insert the spreader tool into the openings of the coolers above and below the diode or thyristor which is to be replaced (see *Figure 3-2*).



Note: Do not use the extensions available for the spreader tool. The extensions cause the cooler above the faulty semiconductor to be depressed by the flexible connectors at the rear of the stack, thus squeezing the semiconductor.



Note: When replacing a semiconductor which is next to a pulse transformer, remove the wires before inserting the spreader tool. The wires can be easily caught in the gears of the spreader tool.

- 4 **Alternately** release the clamping pressure and then spread the spreader tool to maintain the pressure in the stack above the semiconductor to be changed.

Proceeding in this manner prevents the semiconductors from becoming misaligned.

- 5 Remove the semiconductor as soon as the clearance above the semiconductor is big enough.
- 6 Prepare the new semiconductor for reassembly.

Check the contact surfaces of the new diode for any dirt. If necessary, clean the contact surfaces with an appropriate solvent (e. g. alcohol). Using a fluff-free cloth wipe the surfaces paying attention not to scratch the surfaces.



Note: Do not use any grease or any electrical joint compound.

- 7 Insert the new semiconductor into the stack and center it.
Pay attention to the correct polarity. Always verify the polarity with the corresponding wiring diagram.
- 8 Alternately close the gap between the new semiconductor and the cooler and increase the pressure in the stack until the pressure adjustment spanner can be removed.
- 9 Reconnect any disconnected wires.

In case a stack becomes misaligned, the coolers can be pushed back into place and the semiconductors can be centered using a fixture as illustrated in *Figure 3-3*.

The two horizontal bars are fixed to the frame of the cabinet. By means of the adjustment bolts, the wooden bar is pushed against the coolers thus pushing the coolers back into place and holden them there. The semiconductors can be centered one by one starting at the bottom of the stack. The spreader tool is used to create the clearance for moving the semiconductors into place. Since the space is very narrow it is recommended to use a piece of wire shaped into a half moon to move the semiconductors.

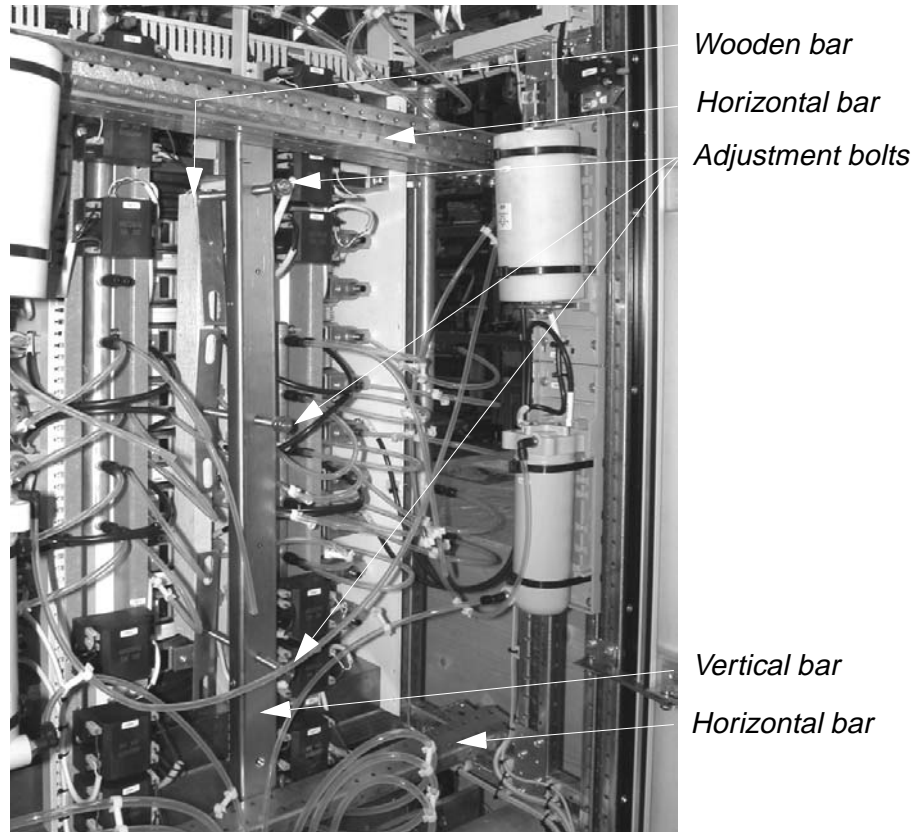

Figure 3-3 *Fixture*

Chapter 4 - Changing 3/5 MVA Phase Modules

4.1 Required Tools and Accessories

The tools listed below are part of the tool set (ident. No. 3BHS130246) delivered with the ACS 6000.

- Lifting device (customer crane or ACS 6000 hoist), two rails

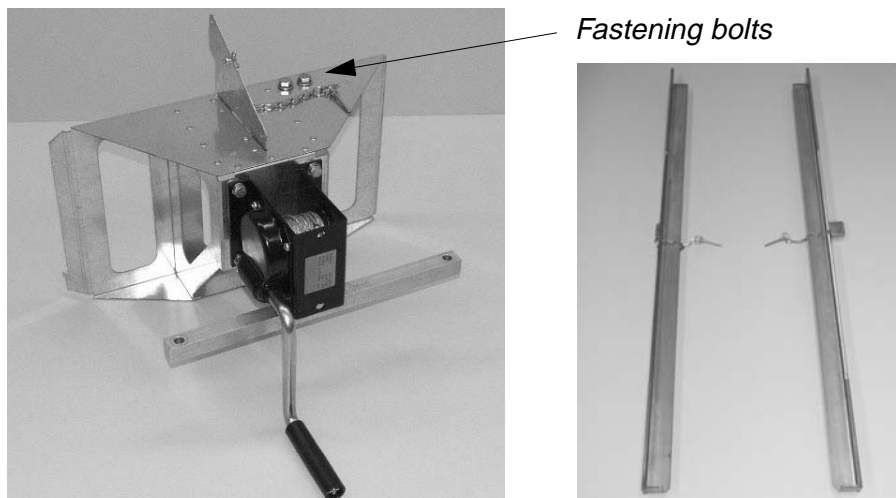

Figure 4-1 ACS 6000 Hoist and Rails

- Two eyebolts (DIN 580, M12) for lifting the phase module by means of an overhead crane
- Wrench with extension bar (approx. 80 cm) and 10 mm ball end hex driver for replacing the phase module
- 18 mm ring spanner to unscrew the clamp pressure loading gauge attached to the side of the phase module
- 12 mm hex driver to open the pressure adjustment bolt of the stack
- Side cutter
- Torque wrench
- MOLYKOTE (type D) assembly grease and RHODORSIL (type 4) silicone paste

4.2 Removing a Phase Module

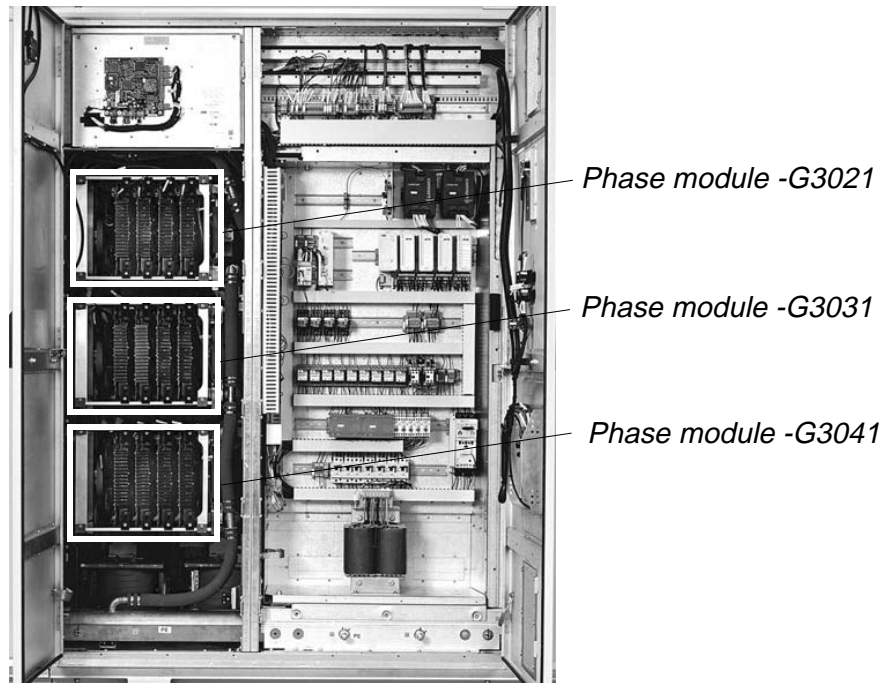

Figure 4-2 Phase Modules

- 1 Deenergize and ground the ACS 6000.
- 2 Stop the cooling water pumps and make sure that they cannot be switched on by accident.



Danger: The ACS 6000 is a high voltage device.

Make sure that the cabinet has been completely deenergized and that power cannot be applied by accident.

Failure to do so may result in injury or death.



Note: After switching off the mains and after the motor has come to a stop, allow the DC link capacitors to discharge. The light **GND.- SWITCH UNLOCKED** must be on, before grounding the ACS 6000.

- 3 Switch off the auxiliary power supply of the IGCTs. Refer to the wiring diagram to identify the circuit breaker.

- 4 Disconnect all cooling water input and output couplings of the three phase modules (see arrows in *Figure 4-3 a*). To disconnect the water hose pull the locking sleeve of the coupling towards the front of the cabinet (see arrow in *Figure 4-3 b*).

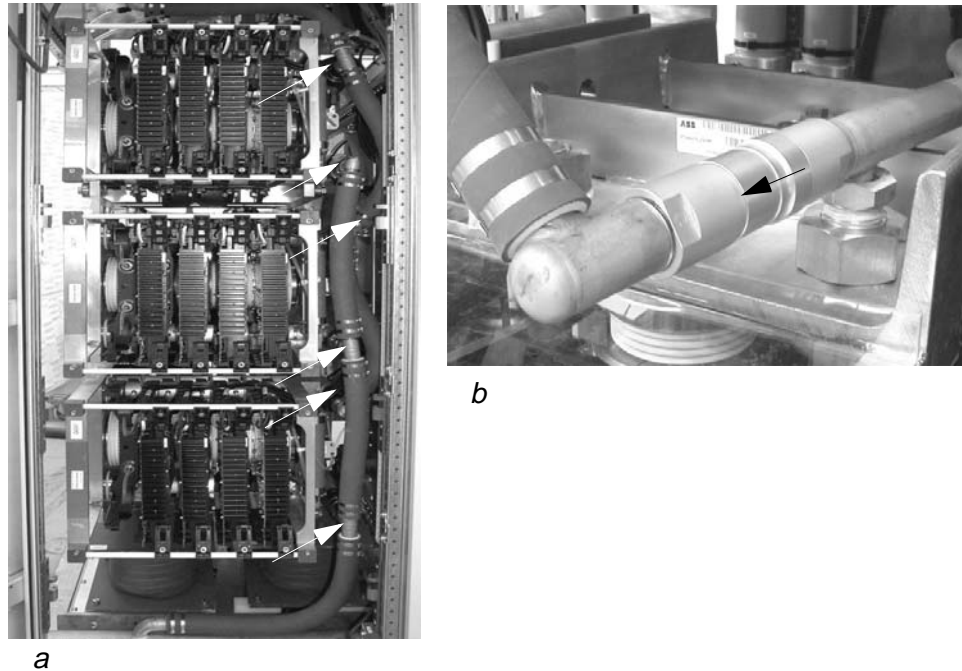

Figure 4-3 Water Hose Couplings

- 5 Carefully cut off the cables ties which fasten the fiber optic cables and power supply leads.
- 6 Disconnect the fiber optic cables (4) and the power supply leads (4) from the module to be changed (see arrows *Figure 4-4*).

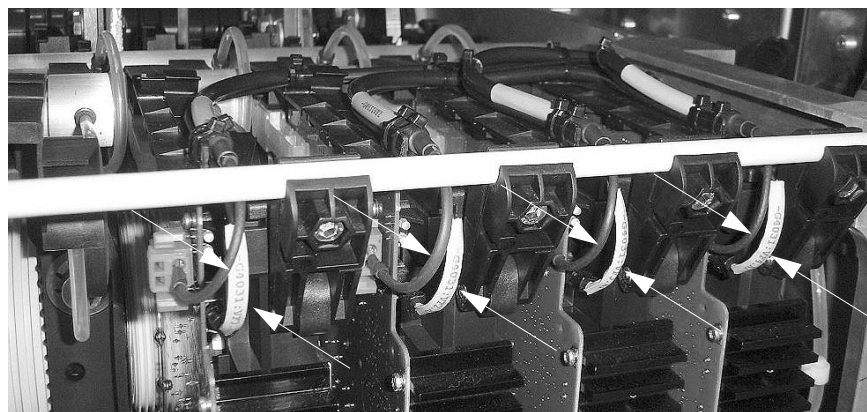

Figure 4-4 Disconnecting Fiber Optics and Power Supply Cables

- 7 Slide each rail under the phase module to be changed until the rail inserts properly into the bracket at the back of the module.

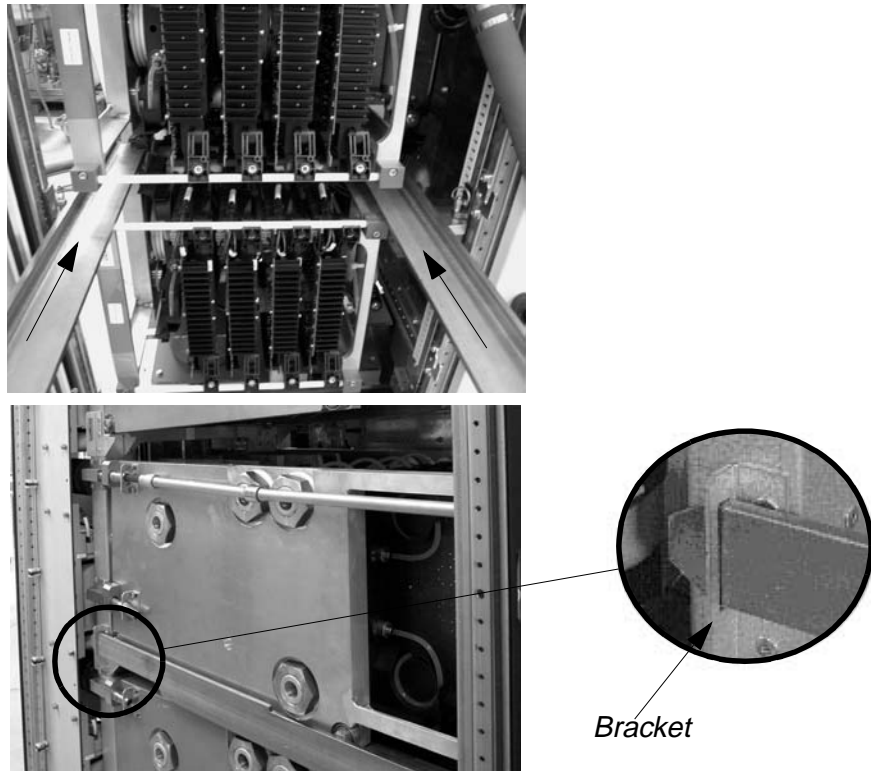

Figure 4-5 Mounting the Rails

- 8 Secure the rails by inserting the safety pins at the front, one on each side of the phase module.



Figure 4-6 Safety Pin

- 9** Unscrew the fastening bolts at the back. There are two bolts on each side. Unscrew the lower fastening bolts and then the upper fastening bolts (see *Figure 4-7*). The phase module will be lowered and the wheels of the module will touch the rails.

Required tools:

- Wrench
- 80 cm extension
- 10 mm ball end hex driver

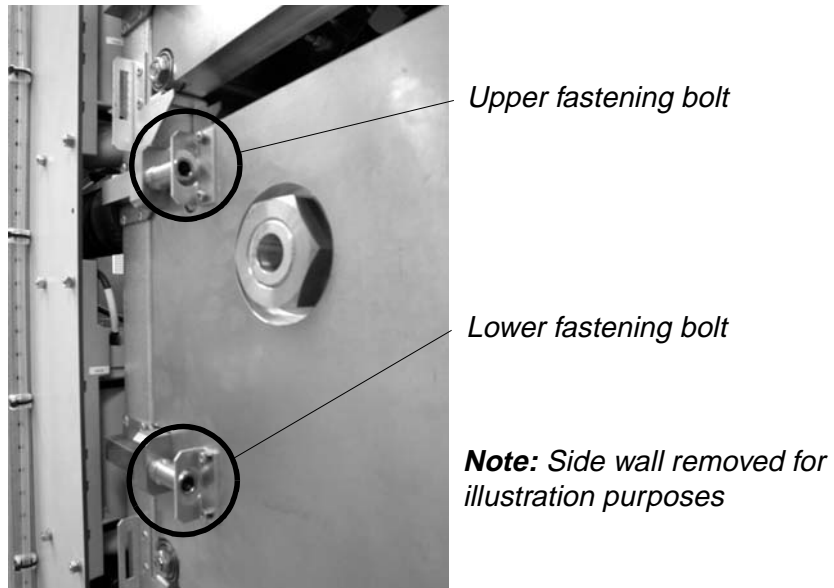

Figure 4-7 Fastening Bolts

- 10** Extract the phase module from the cabinet.
- 11** Lift the phase module from the rails.
- 1 Continue with step **12** when using the ACS 6000 hoist.
 - 2 Continue with step **16** when using a crane.

Using the Hoist **12** Attach the hoist to the cabinet at the three connection points (see circles in *Figure 4-8*).

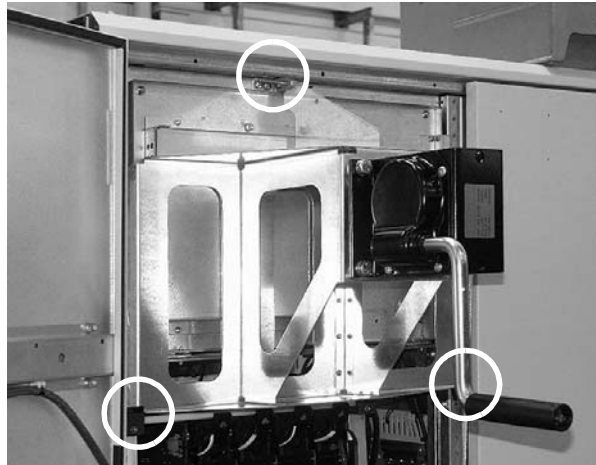

Figure 4-8 Attaching the Hoist

13 Attach the lifting bar to the phase module using two M12 bolts.



Figure 4-9 Lifting Attachments

- 14** Lift the phase module high enough to be able to withdraw the rails.

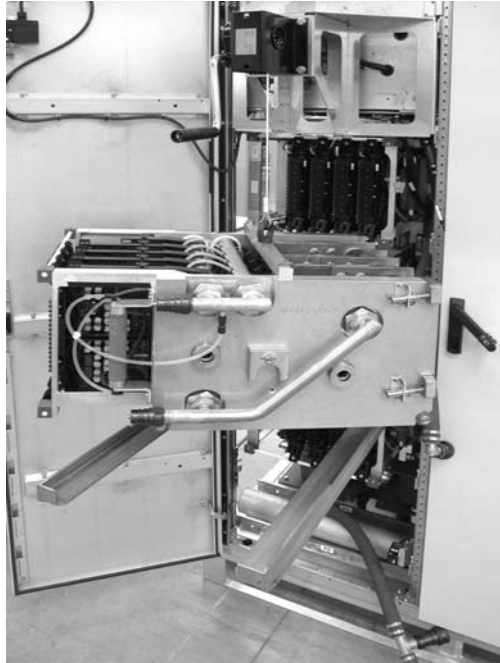

Figure 4-10 Phase Module Attached to Hoist

- 15** After the rails have been removed slowly lower the phase module to the floor.

Using a Crane

- 16** Screw the two eyebolts into the tapped holes of the lifting bar, attach the phase module to the crane and lift it from the rails.



Fastening bolts

Figure 4-11 Phase Module Attached to Crane

4.3 *Installing a Phase Module*

- 1 Grease the four fastening bolts of the phase module with MOLYKOTE (type D).

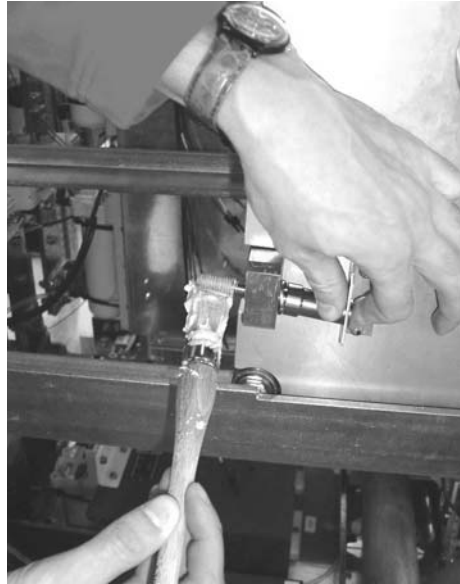

Figure 4-12 Greasing Fastening Bolts

- 2 Grease the ends of the busbar stubs using grease of type RHODORSIL or SILICONPASTE 4. See arrows in *Figure 4-13*.

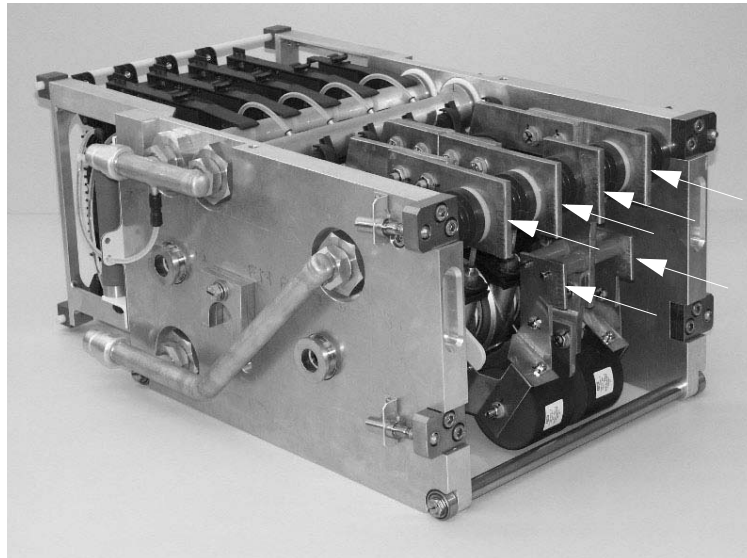

Figure 4-13 Greasing Busbar Stubs

- 3 Lift the phase module onto the rails by means of the ACS 6000 hoist

(see section *Using the Hoist*) or an overhead crane (see section *Using a Crane*).

- 4** Remove the lifting attachments.
- 5** Push the phase module slowly towards the back wall until it stops.
- 6** Screw in the fastening bolts, first the upper bolts and then the lower bolts.
- 7** Tighten all fastening bolts with a torque wrench to the final torque rate of **83 Nm**.
- 8** Remove the rails.
- 9** Connect the fiber optics and power supply cables and fix them with cable ties.
- 10** Check each water hose coupling for damage before connection. If damaged the coupling must be changed.
- 11** Reconnect the water hose couplings. To connect a water hose coupling pull the locking sleeve of the female half of the coupling back as far as possible. While holding it in this position, push it over the fixed male half of the coupling until it stops. Now, let go the locking sleeve and firmly push the female part against the male part until the coupling locks home with a click.
- 12** Power up the drive and confirm its proper functioning.



Chapter 5 - Changing RC-IGCTs in 3/5 MVA Phase Modules

- 1 Follow section 4.2 *Removing a Phase Module* until the phase module has been extracted from the cabinet.
The phase module can remain on the rails for replacing an RC-IGCT.
- 2 Loosen the hexagon fastening bolts (12) (see arrows in *Figure 5-1*) of the RC-IGCTs and pull out the two retaining rods.

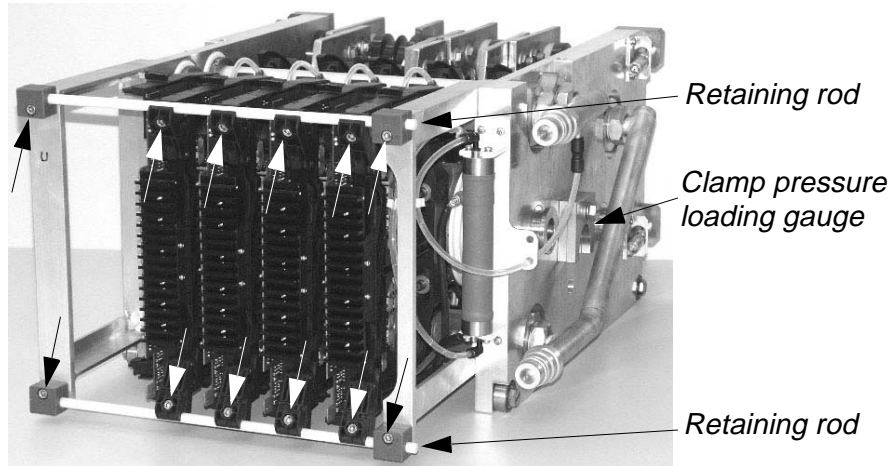

Figure 5-1 Phase Module

- 3 Slide the clamp pressure loading gauge (attached to the side of the phase module, see *Figure 5-1*) under the clamp ring of the pressure adjusting bolt and loosen the bolt to release the clamp pressure of the stack.

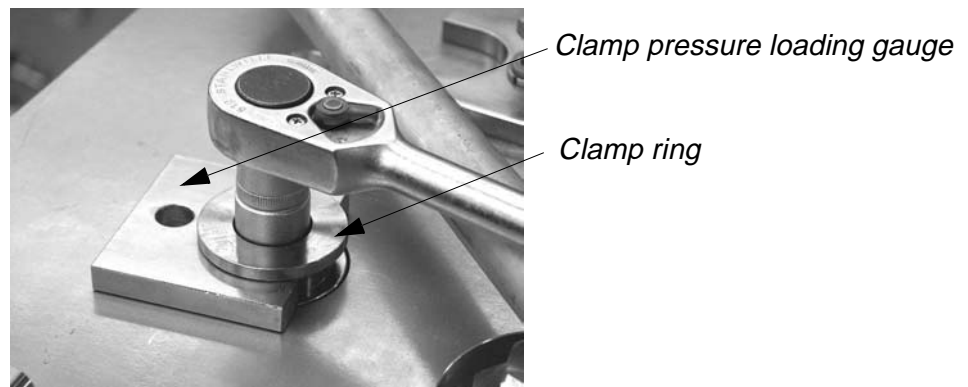

Figure 5-2 Releasing the Clamp Pressure

- 4 Pull out the faulty RC-IGCT.
- 5 In case the new IGCT is not fitted with retaining clamps and guides (see *Figure 5-3*) remove these parts from the faulty IGCT and mount

them on the new IGCT.

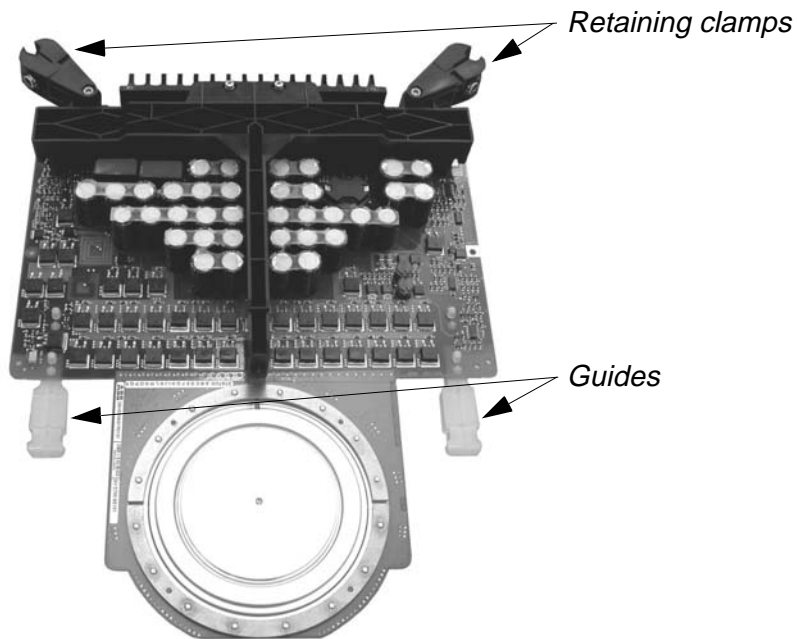

Figure 5-3 IGCT

- 6 Thoroughly clean the contact surfaces of the cooler and the anode and cathode of the new RC-IGCT with an appropriate solvent (e. g. alcohol). Using a fluff-free cloth wipe the surfaces paying attention not to scratch the surfaces.



Note: Do not use any grease or any electrical joint compound.

- 7 Push the new RC-IGCT into the stack.
- 8 Tighten the pressure adjusting bolt until the gauge is released.
- 9 Fasten the gauge in its storage place.
- 10 Remount the retaining rods and fasten the RC-IGCTs.
- 11 Push the phase module back into the cabinet following the instructions in section 4.3 *Installing a Phase Module*.

Chapter 6 - Changing Clamp Diodes in 3/5 MVA Phase Modules

6.1 Required Tools and Accessories

See section 4.1 *Required Tools and Accessories*.

6.2 Changing Procedure

- 1 Remove the phase module from the cabinet. Follow section 4.2 *Removing a Phase Module*.
- 2 Place the module on a flat surface.
- 3 To change the NP diode the phase module needs to be turned onto the side where there are no water connections.

Unscrew the retaining brackets of the fastening bolts (see *Figure 6-1*) before turning the phase module over or place the phase module on two wooden beams (see *Figure 6-2*) to prevent damaging the brackets.

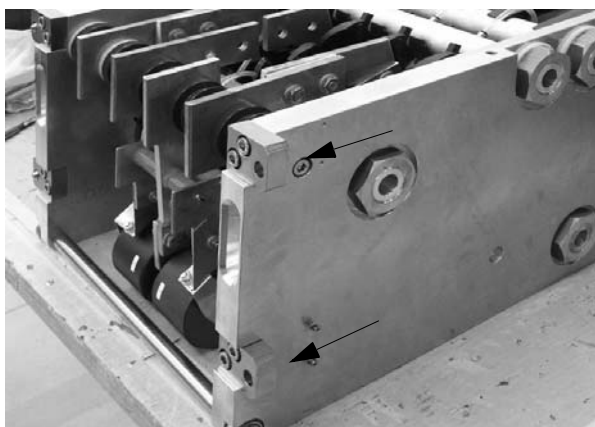

Figure 6-1 Phase Module with Fastening Bolts Removed



Figure 6-2 Phase Module Placed on two Wooden Beams

- 4 Slide the clamp pressure loading gauge under the clamp ring of the pressure adjusting bolt and loosen the bolt to release the clamp pressure of the stack (see Figure 6-3).

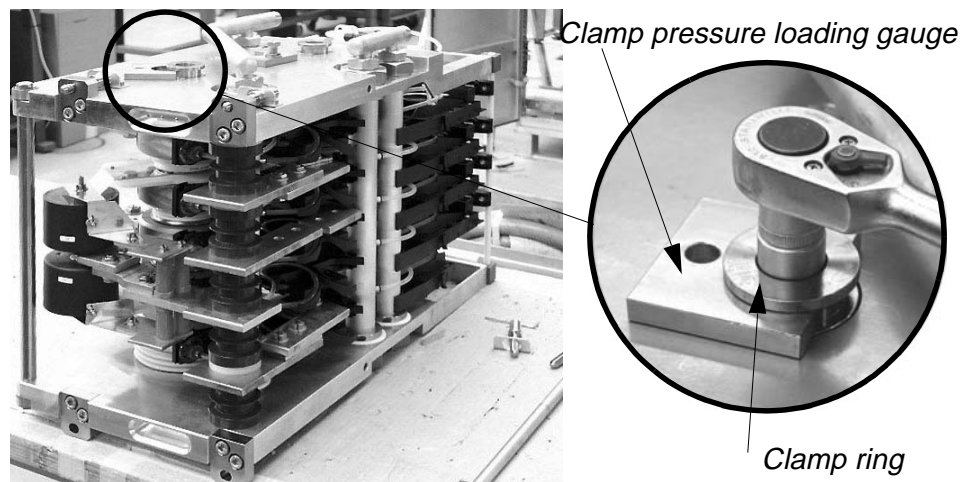

Figure 6-3 Releasing the Clamp Pressure

- 5 Remove the isolator disc at the top of the stack.



Figure 6-4 Removing Isolator Disk

- 6 Lift the cooler which is above the diode to be changed and then remove the diode.

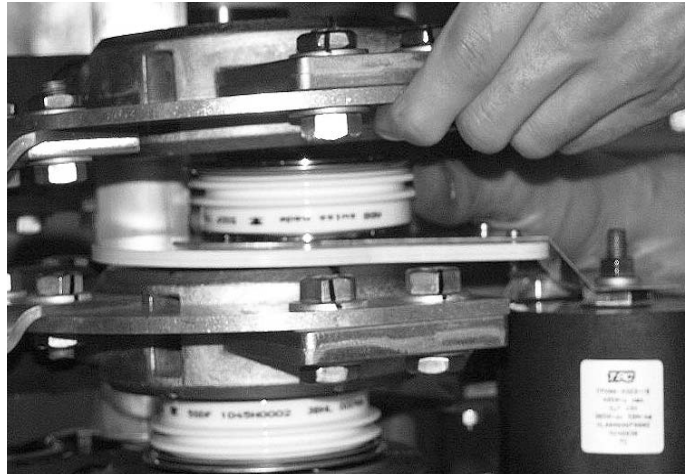

Figure 6-5 Removing the Diode

- 7 Thoroughly clean the contact surfaces of the cooler, the isolator disk and the new diode with an appropriate solvent (e. g. alcohol). Using a fluff-free cloth wipe the surfaces paying attention not to scratch the surfaces.



Note: Do not use any grease or any electrical joint compound.

- 8 Place the new diode in the stack.
- 9 Put the isolator disc back in its place.
- 10 Tighten the pressure adjusting bolt until the clamp pressure loading gauge is released.
- 11 Refit the clamp pressure loading gauge in its storage place on the side of the phase module.
- 12 Turn the phase module back into the proper mounting position.
- 13 Reconnect the mounting brackets with the fastening bolts.
- 14 Lift the module onto the rails and install the phase module following section 4.3 *Installing a Phase Module*.

Chapter 7 - Changing 7/9 MVA Phase Modules

7.1 Required Tools and Accessories

The tools and accessories listed below are part of the tool set (Ident. no. 3BHS130246) delivered with the ACS 6000.

- ACS 6000 lifting table



Figure 7-1 ACS 6000 Lifting Table

- Wrench with extension bar (approx. 80 cm) and 16 mm ball end hex driver for replacing the phase module
- 12 mm hex driver to open the pressure adjustment bolt of the stack
- Side cutter
- Cable ties
- Plastic sheet or cloth to catch dripping water

7.2 Removing a Phase Module

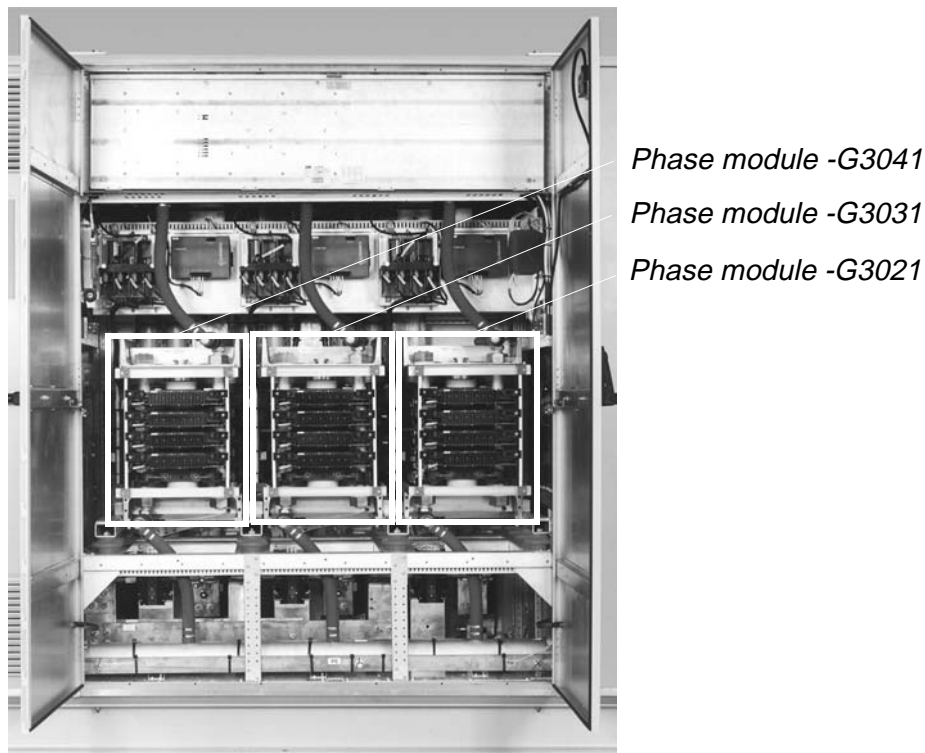

Figure 7-2 Phase Modules

- 1 Deenergize and ground the ACS 6000.
- 2 Stop the cooling water pumps and make sure that they cannot be switched on by accident.



Danger: The ACS 6000 is a high voltage device.

Make sure that the cabinet has been completely deenergized and that power cannot be applied by accident.

Failure to do so may result in injury or death.



Note: After switching off the mains and after the motor has come to a stop, allow the DC link capacitors to discharge. The light **GND.- SWITCH UNLOCKED** must be on, before grounding the ACS 6000.

- 3 Switch off the auxiliary power supply. Refer to the wiring diagrams to identify the circuit breaker.

- 4 Before disconnecting the top water hose, cover the equipment below a coupling with a plastic sheet (see *Figure 7-3*) or hold a towel or cloth underneath the coupling to prevent water from getting inside the phase module or the measuring board below.

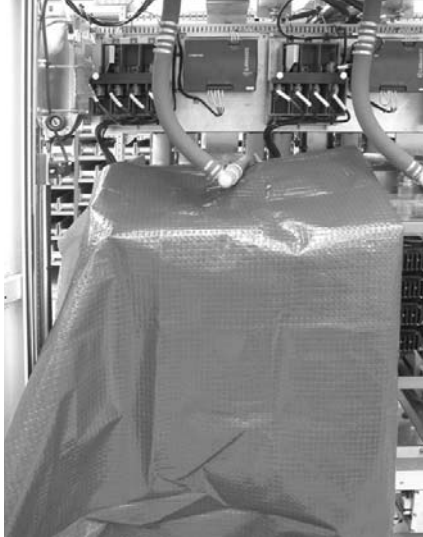

Figure 7-3 Protecting Cover

- 5 Disconnect the upper hose first and then the lower hose. To disconnect the water hose pull the locking sleeve of the coupling towards the front of the cabinet (see arrow in *Figure 7-4*).

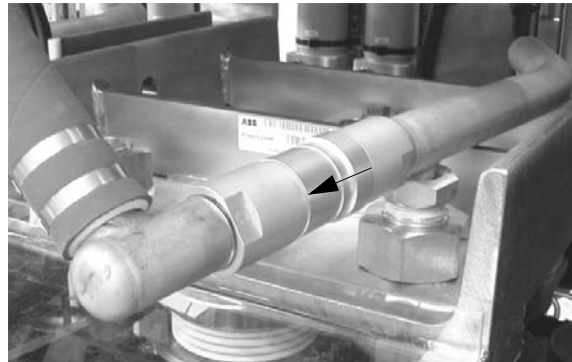

Figure 7-4 Disconnecting a Water Hose

- 6 Wipe off any spilled water immediately.

- 7 Cut off the cable ties on the side of the phase module (see circles in *Figure 7-5*) and then disconnect the fiber optic cables and the power supply leads (see arrows in *Figure 7-5*).

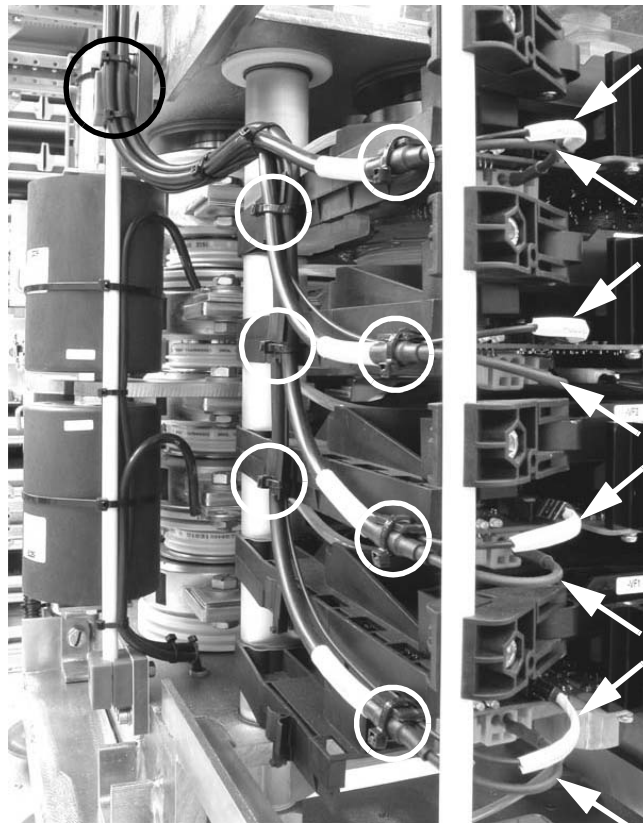
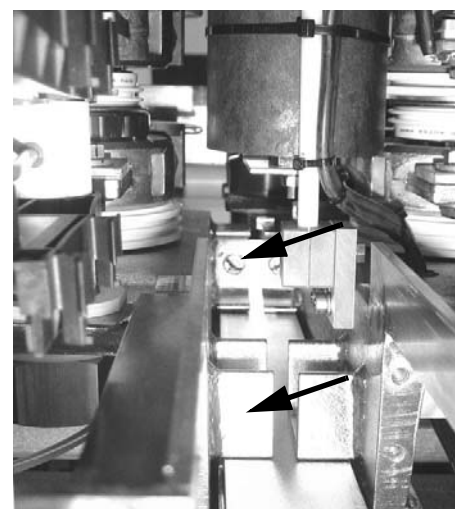

Figure 7-5 Disconnecting Fiber Optics and Power Supply Cables

- 8 Remove the two fastening bolts at the bottom of each side of the phase module. See arrows in *Figure 7-6*.



Left side



Right side

Figure 7-6 Removing the Fastening Bolts

- 9 Position the lifting table in front of the phase module and adjust the height of the table.
- 10 Make sure that the disconnected water hoses, fiber optic cables and power supply leads are well out of the way to prevent damaging them when pulling out the phase module.
- 11 Pull the phase module onto the table.



Note: The phase module is heavy (approx. **90 kg**). It is recommended that two people extract the phase module from the cabinet.

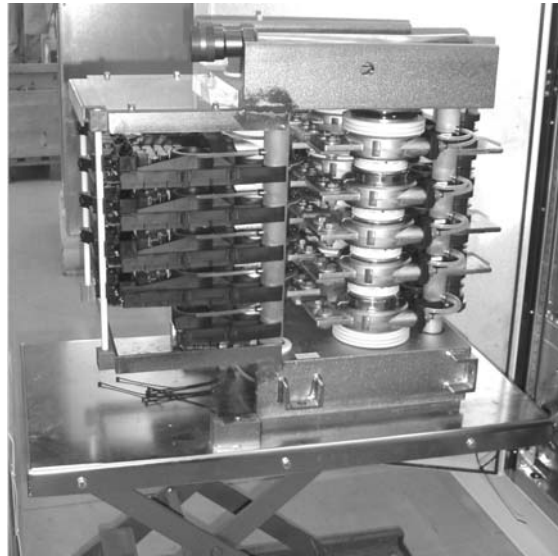

Figure 7-7 Phase Module Removed from Cabinet

7.3 Installing a Phase Module

- 1 Grease the ends of the busbar stubs using grease of type RHODORSIL or SILICONPASTE 4.
- 1 Make sure that the disconnected water hoses, fiber optics and power supply cables are well out of the way before pushing the phase module into the cabinet.
- 2 Position the lifting table and adjust the required height.
- 3 Push the phase module slowly towards the back wall until it locks into the busbars.
- 4 Screw in the fastening bolts (two bolts on each side) and tighten them.
- 5 Cover the equipment below a coupling by a plastic sheet (see Figure 7-3) or hold a towel or cloth underneath the coupling before connecting the water hoses.

- 6** Reconnect the two water hoses. First the bottom hose and then the upper hose.
To connect a water hose coupling pull the locking sleeve of the female half of the coupling back as far as possible. While holding it in this position, push it over the fixed male half of the coupling until it stops. Now, let go the locking sleeve and firmly push the female part against the male part until the coupling locks home with a click.
- 7** Wipe off any spilled water immediately.
- 8** Reconnect the fiber optic and power supply cables (see arrows in *Figure 7-5*).
Do not mix up the cables. The denomination on the label of a cable must correspond to its counterpart on the phase module. Always verify the correct connection with the corresponding wiring diagram.
- 9** Fasten the cables with cable ties (see circles in *Figure 7-5*).
- 10** Power up the drive and confirm its proper functioning.
- 11** If a defective part has to be returned to ABB, particularly if it is still under warranty, follow the procedures as stated in the Warranty Directive (this is recommended even if the warranty period has expired).

Chapter 8 - Changing Diodes and IGCTs in 7/9 MVA Phase Modules

8.1 Required Tools and Accessories

The tools listed below are part of the tool set (ident. no. 3BHS130246) delivered with the ACS 6000.

- Spreader tool



Figure 8-1 Spreader Tool

- Two 23 mm extra thin open end spanners
- Set of hex keys
- 10 mm combination spanner
- 13 mm ratcheting combination wrench
- ¼ " reversible ratchet
- 10 mm ¼" drive socket
- ½ " reversible ratchet
- 100 mm ½ " extension bar
- 12 mm ½" hex socket
- 13 mm ½" drive socket
- 18 mm hex ½" drive socket
- Torque wrench
- Cable ties

8.2 Overview

The phase module must be extracted from the cabinet to replace the clamp, NP and free wheeling diodes but can remain in the cabinet to replace IGCTs.

Refer to *Chapter 7 - Changing 7/9 MVA Phase Modules* for information on removing a phase module from the cabinet.

Refer to *Figure 8-3* to locate the semiconductors.

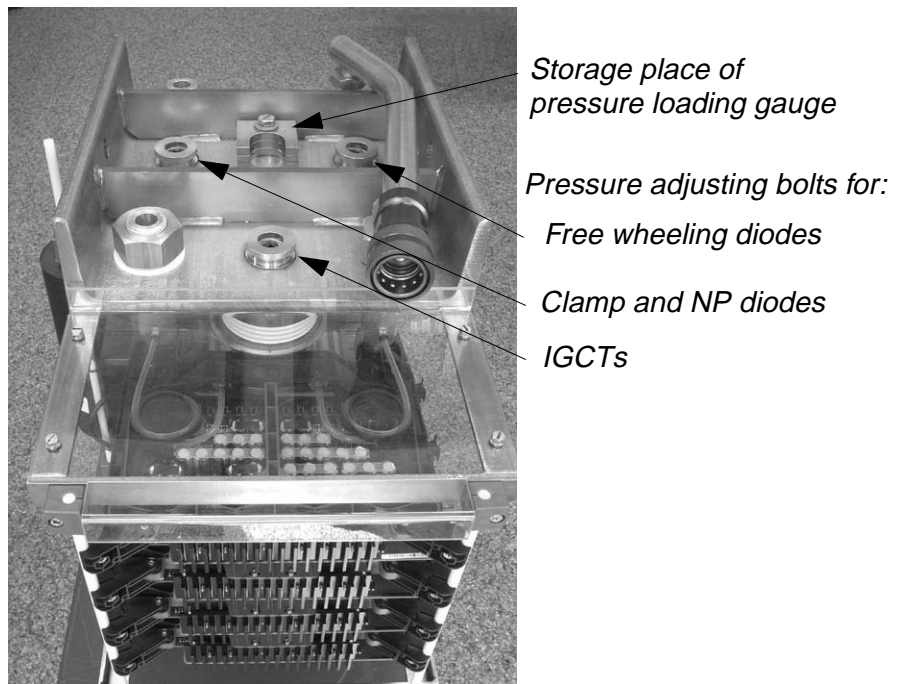

Figure 8-2 Phase Module

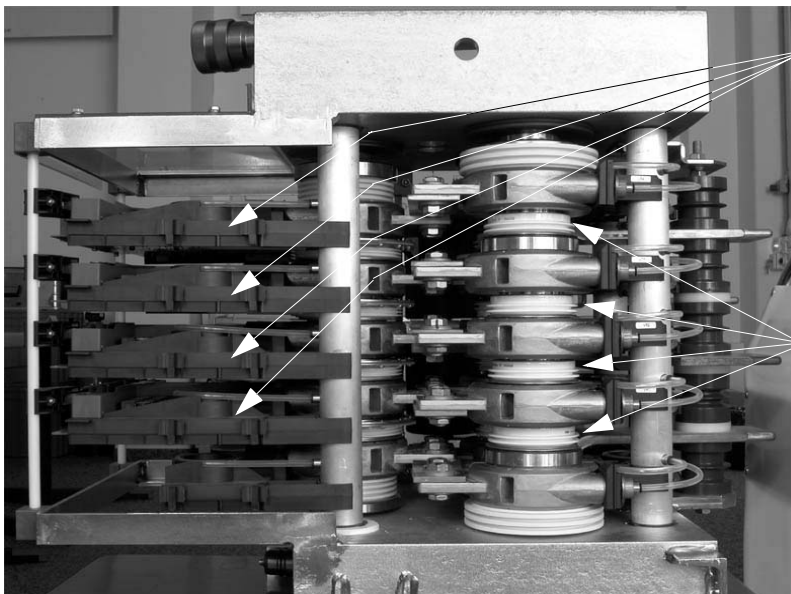
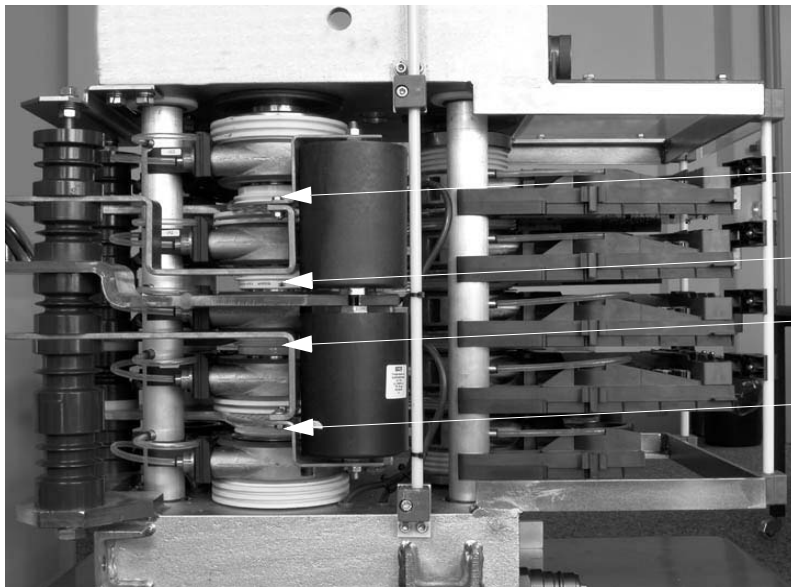

Figure 8-3 Phase Module

8.3 Safety

Before starting any work on the phase module do the following:

- 1 Deenergize and ground the ACS 6000.



Danger: The ACS 6000 is a high voltage device.

Make sure that the cabinet has been completely deenergized and that power cannot be applied by accident.

Failure to do so may result in injury or death.



Note: After switching off the mains and after the motor has come to a stop, allow the DC link capacitors to discharge. The light **GND.- SWITCH UNLOCKED** must be on before grounding the ACS 6000.

- 2 Switch off the auxiliary power supply. Refer to the wiring diagrams to identify the circuit breaker.

8.4 Replacing Clamp and NP Diodes

Clamp and NP Diodes are mounted in the same stack. See *Figure 8-3* to locate the semiconductors.

8.4.1 Preparatory Steps

- 1 Check that the drive has been deenergized and voltages have been removed from the cabinet. See section *8.3 Safety*.
- 2 Slide the clamp pressure loading gauge under the clamp ring of the pressure adjusting bolt and remove the bolt to release the clamp pressure of the stack using the 12 mm ½" hex socket from the tool box.

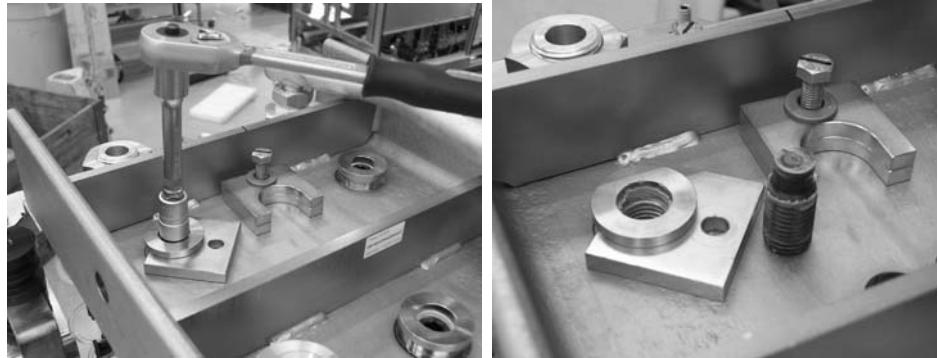

Figure 8-4 Releasing the Clamp Pressure

- 3 Remove the clamp capacitors.
To release the clamp capacitors the nuts and hex head set screws must be removed at the top and at the bottom end (see circles in *Figure 8-5*) and the connection in the middle loosened (see arrow in *Figure 8-5*).

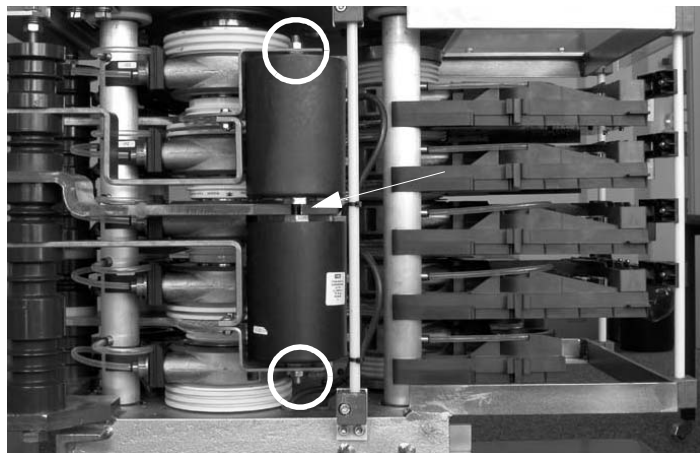

Figure 8-5 Removing Clamp Capacitors

Remove the top nut using the 13 mm wrench while holding the set screw with a 4 mm hex key (see *Figure 8-6*).

Do the same at the opposite end.

Finally remove the set screws at both ends taking care not to apply too much force. Using too much force will destroy the capacitors.



Figure 8-6 Removing the Top Fastening Nut

- 4 Using the two extra thin 23 mm open end spanners slightly loosen the connection between the two capacitors until they are free but do not completely unscrew the threaded pin which connects the capacitors.



Figure 8-7 Loosening the Middle Connection

- 5 Remove the capacitors.

- 6 Remove the top isolator disc from the stack to create more clearance facilitating work on the diodes.

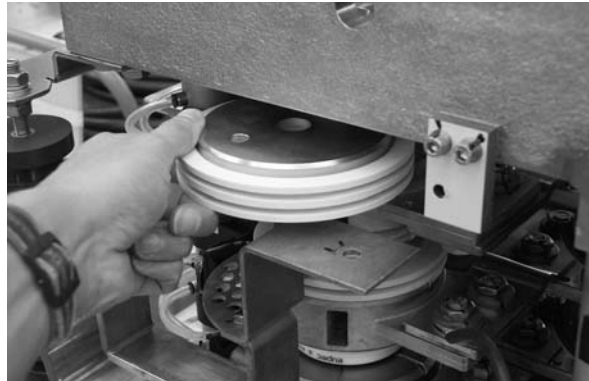

Figure 8-8 Removing Isolator Disc

- 7 Remove the fastening bolts of the upper perforated busbar (see circle in Figure 8-9).

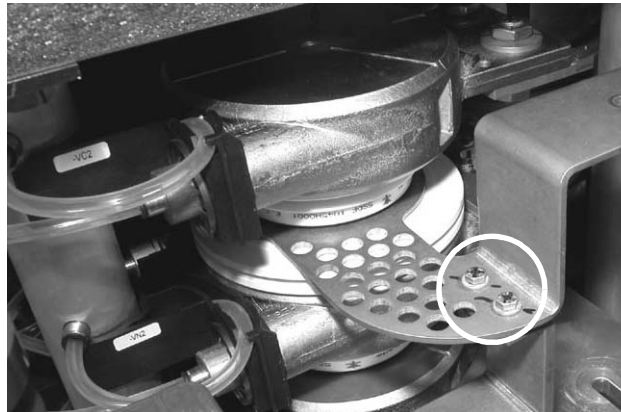

Figure 8-9 Removing Fastening Bolts of Perforated Busbar

- 8 Continue with section 8.4.2 if clamp diodes have to be replaced.
Continue with section 8.4.3 if NP diodes have to be replaced.

8.4.2 Replacing Clamp Diodes

Upper Clamp Diode After the steps of section 8.4.1 *Preparatory Steps* have been carried out do the following:

- 1 Remove the upper clamp diode, the isolator disc and the perforated busbar.

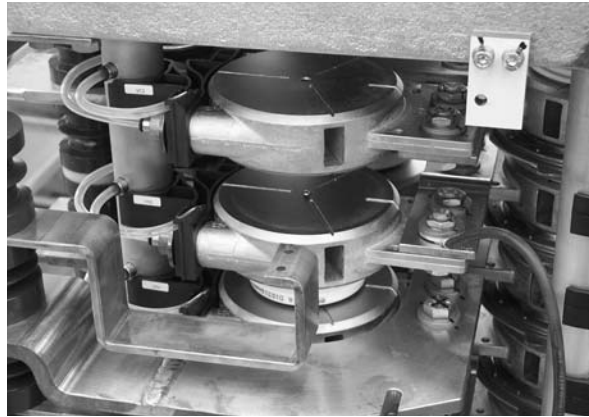

Figure 8-10 Upper Clamp Diode Removed

- 2 Prepare the components for reassembly.

Check the contact surfaces of the new diode, the isolator disk and the coolers for any dirt. If necessary, clean the contact surfaces with an appropriate solvent (e. g. alcohol). Using a fluff-free cloth wipe the surfaces paying attention not to scratch the surfaces.



Note: Do not use any grease or any electrical joint compound.

- 3 Put the new diode, the perforated busbar and the isolator disk on top of each other (mind the correct order) and center them before inserting the parts into the stack.

Pay attention to the correct polarity particularly when exchanging diodes from different suppliers. Always verify the polarity with the corresponding wiring diagram.

- 4 Insert the top isolator disk and center it.

This step must be left out if the lower clamp diode has to be replaced as well.

- 5 Continue with section *Lower Clamp Diode* if the lower diode has to be replaced.

Continue with section 8.4.4 *Finishing Steps* to remount the capacitors, adjusting the clamp pressure and installing the phase module.

Lower Clamp Diode After the steps of section 8.4.1 *Preparatory Steps* have been carried out do the following:

- 6** Remove the fastening bolts of the lower perforated busbar and turn it to the side to make room for the spreader tool.

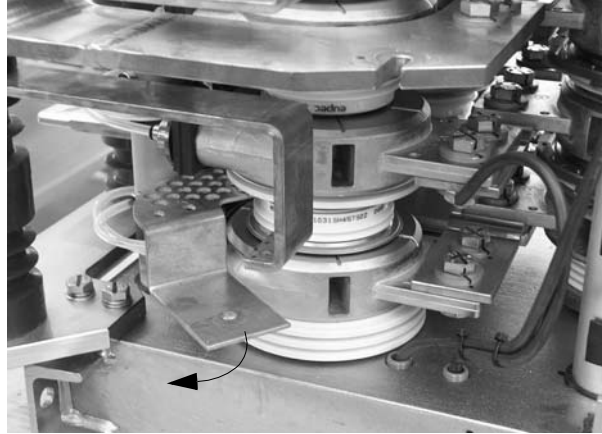

Figure 8-11 Perforated Busbar Turned Aside

- 7** Insert the spreader tool into the openings of the cooler.

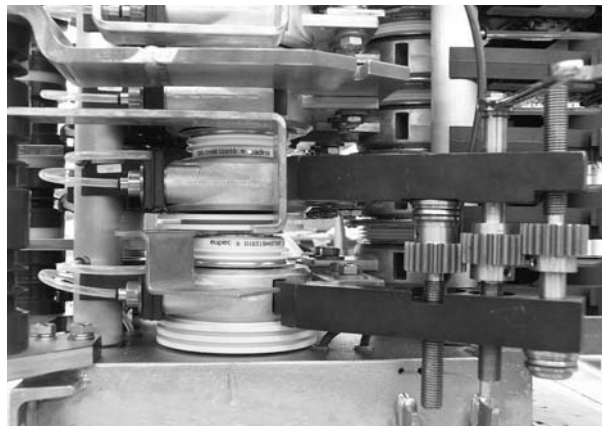

Figure 8-12 Spreader Tool Inserted

- 8** By adjusting the spreader tool push up the cooler above the diode until the diode is free.

Remove the lower clamp diode, the isolator disc and the perforated busbar.



Figure 8-13 Lower Clamp Diode Removed

- 9** Prepare the components for reassembly.

Check the contact surfaces of the new diode, the coolers and the isolator disc for any dirt. If necessary, clean the contact surfaces with an appropriate solvent (e. g. alcohol). Using a fluff-free cloth wipe the surfaces paying attention not to scratch the surfaces.



Note: Do not use any grease or any electrical joint compound.

- 10** Put the isolator disk, the perforated busbar and the new diode on top of each other (mind the correct order) and center them before inserting the parts into the stack.

Pay attention to the correct polarity particularly when exchanging diodes from different suppliers. Always verify the polarity with the corresponding wiring diagram.

When inserting the components be careful to keep them centered.

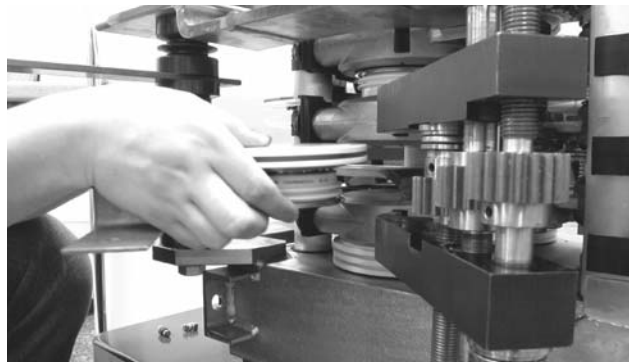

Figure 8-14 Inserting the Diode

- 11** Continue with section 8.4.4 *Finishing Steps*.

8.4.3 Replacing NP Diodes

Removing Upper NP Diode After the steps of section 8.4.1 *Preparatory Steps* have been carried out do the following:

- 1 Turn the u-shaped busbar to the side for easier access to the upper NP diode.

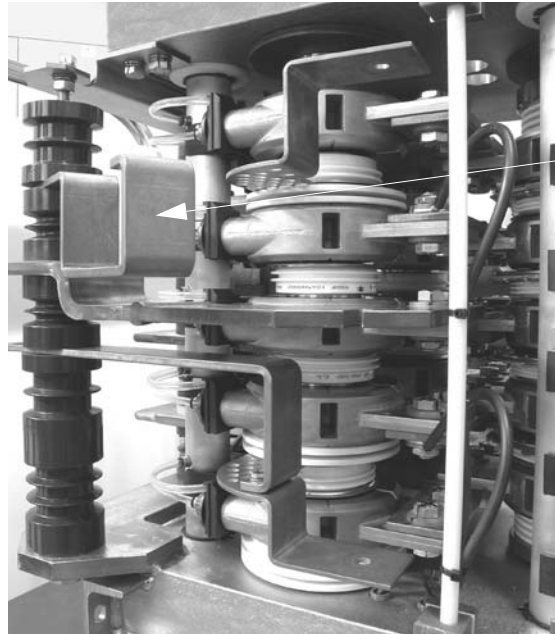

U-shaped busbar

Figure 8-15 Replacing NP Diodes

- 2 Lift the cooler above the diode with one hand and extract the diode from the stack with the other.



Upper NP Diode removed

Figure 8-16 Upper NP Diodes Removed

- 3 Continue with section *Removing Lower NP Diode* if the lower diode has to be replaced.
If not, continue with section *Assembling the Stack*.

Removing Lower NP Diode After the steps of section 8.4.1 *Preparatory Steps* and section *Removing Upper NP Diode* (up to step 3) have been carried out do the following:

- 4 Lift the cooler and the busbar above the NP diode with one hand and extract the diode from the stack with the other hand.

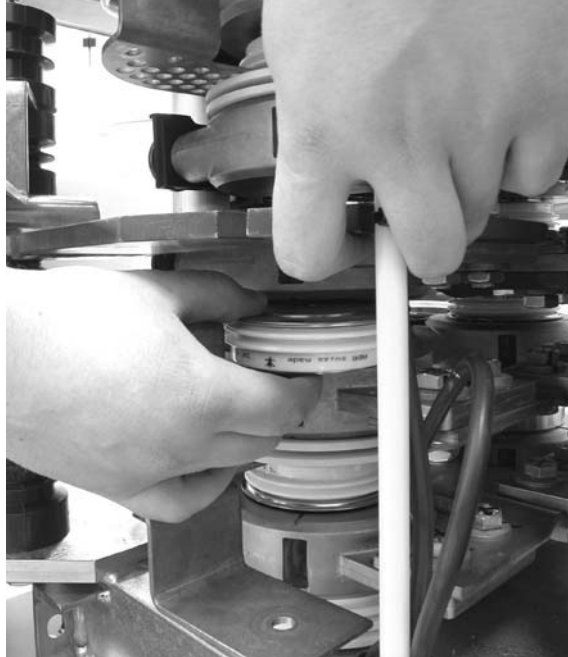

Figure 8-17 Extracting Lower NP Diode

Assembling the Stack

- 1 Check the contact surfaces of the new diode(s) and the coolers for any dirt.
If necessary, clean the contact surfaces with an appropriate solvent (e. g. alcohol). Using a fluff-free cloth wipe the surfaces paying attention not to scratch the surfaces.



Note: Do not use any grease or any electrical joint compound.

- 2 Place the diode(s) in the stack and center it (them).
Pay attention to the correct polarity particularly when exchanging diodes from different suppliers. Always verify the polarity with the corresponding wiring diagram.
- 3 Turn the u-shaped busbar back into place and connect it to the top perforated busbar.

- 4 Continue with section *8.4.4 Finishing Steps* for remounting the capacitors, adjusting the clamp pressure and installing the phase module.

8.4.4 Finishing Steps

- 1 Insert the isolator disk and center it.
- 2 Remount the capacitors.

Proper alignment is important to prevent distortion and lateral forces acting on the capacitors.

When tightening the nuts pay attention not to exceed the maximum tightening torque (M8 nuts: **8 Nm**).

Exceeding the maximum value may result in damage of the capacitors.

- 3 Adjust the clamp pressure of the stack.
Insert the pressure adjusting bolt and tighten it until the clamp pressure loading gauge is released.
- 4 Refit the clamp pressure loading gauge in its storage place.
- 5 Check the blocking/unblocking behaviour of the new diode. Refer to *Chapter 2 - Checking IGCTs and Diodes*.
- 6 Remount the phase module in the cabinet following section 7.3 *Installing a Phase Module*.

8.5 Replacing Free Wheeling Diodes

- 1 Deenergize the drive. See section 8.3 *Safety*.
- 2 Slide the clamp pressure loading gauge under the clamp ring of the pressure adjusting bolt and remove the bolt to release the clamp pressure of the stack using the 12 mm ½" hex socket from the tool box.

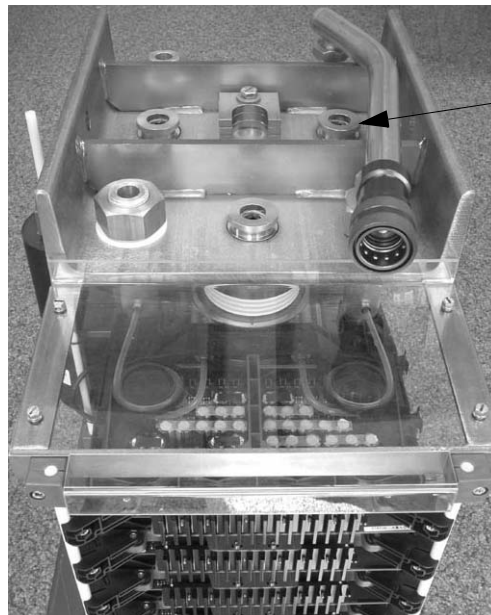

Pressure adjusting bolt

Figure 8-18 Pressure Adjusting Bolt

- 3 Remove the top isolator disc from the stack.



Top isolator disk removed

Figure 8-19 Removing Top Isolator Disk

- 4 Lift the cooler above the diode to be removed with one hand and extract the diode with the other.



Figure 8-20 Removing the Diode

- 5 Prepare the components for reassembly.

Check the contact surfaces of the diode, the cooler and the isolator disk for any dirt. If necessary, clean the contact surfaces with an appropriate solvent (e. g. alcohol). Using a fluff-free cloth wipe the surfaces paying attention not to scratch the surfaces.



Note: Do not use any grease or any electrical joint compound.

- 6 Place the new diode in the stack.

Pay attention to the correct polarity particularly when exchanging diodes from different suppliers. Always verify the polarity with the corresponding wiring diagram.

- 7 Center the diode.

- 8 Slide the isolator disk back into its place.

Pay attention to properly centering the isolator.

- 9 Adjust the clamp pressure of the stack.

Insert the the pressure adjusting bolt and tighten it until the clamp pressure loading gauge is released.

- 10 Refit the clamp pressure loading gauge in its storage place.

- 11 Check the blocking/unblocking behaviour of the new diode. Refer to *Chapter 2 - Checking IGCTs and Diodes*.

- 12 Remount the phase module in the cabinet following section 7.3 *Installing a Phase Module*.
- 13 If a defective part has to be returned to ABB, particularly if it is still under warranty, follow the procedures as stated in the Warranty Directive (this is recommended even if the warranty period has expired).

8.6 Replacing IGCTs

IGCTs can be replaced with the phase module remaining in the cabinet.



Note: If an IGCT is faulty do not replace the semiconductor only. Always replace the complete module (GCT and gate unit).

- 1 Slide the clamp pressure loading gauge under the clamp ring of the pressure adjusting bolt and remove the bolt to release the clamp pressure of the stack using the 12 mm ½" hex socket from the tool box.

The location of the gauge can be seen in *Figure 8-2*.

- 2 Remove the perspex cover on top of the phase module.

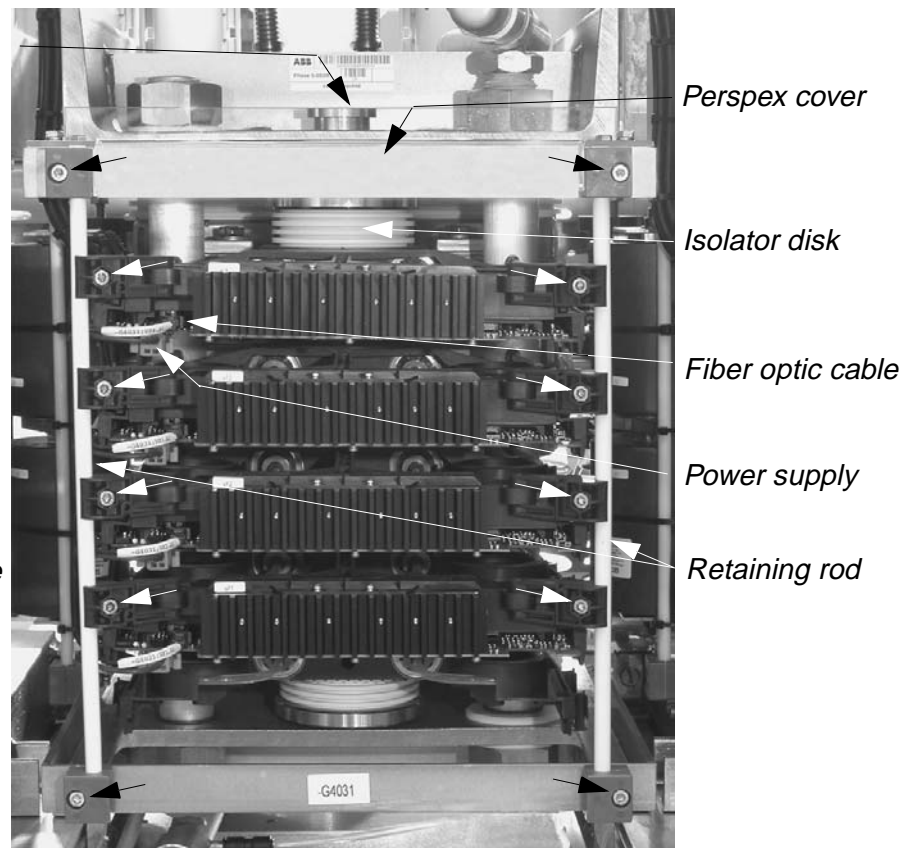
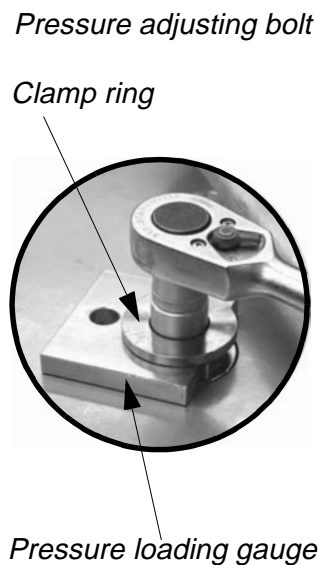

Figure 8-21 Phase Module

- 3 Disconnect the fiber optic cable and the power supply lead of the IGCT to be replaced.
- 4 Loosen all hexagon fastening bolts of the IGCTs (see arrows in *Figure 8-21*) and remove the two retaining rods.
- 5 Extract the top isolator disk.
- 6 Lift the cooler above the faulty IGCT and extract the faulty IGCT.
The cooler above the upper IGCT can be lifted up by hand.
When extracting a lower IGCT it is recommended to use the spreader tool.

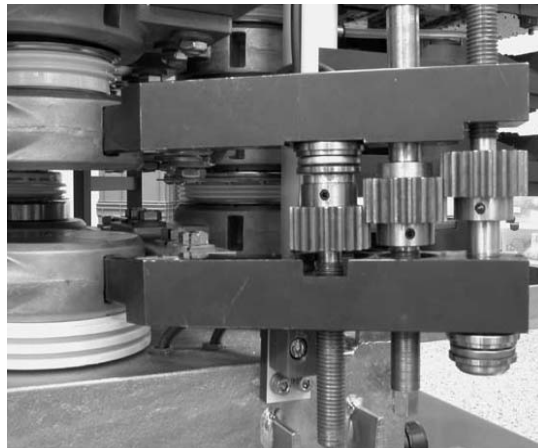

Figure 8-22 Using the Spreader Tool

- 7 In case the new IGCT is not fitted with retaining clamps and guides (see *Figure 8-23*) remove these parts from the faulty IGCT and mount them on the new IGCT.

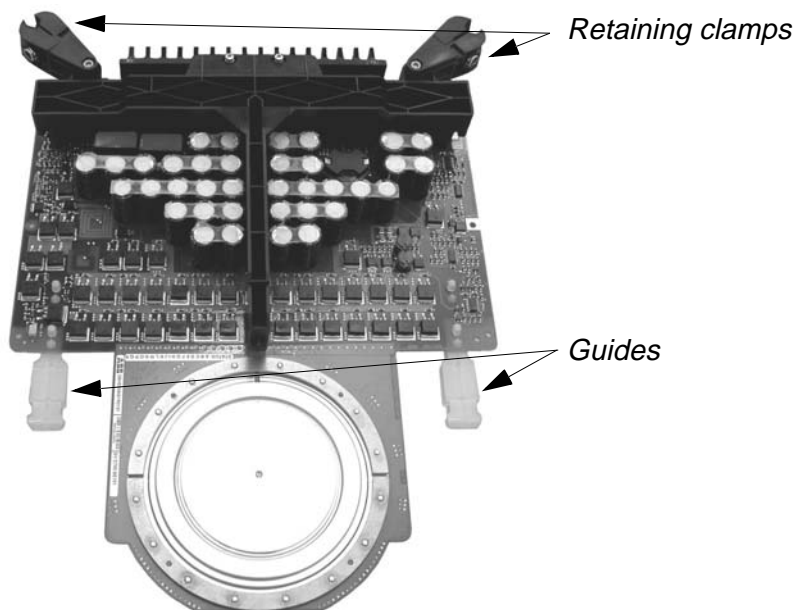

Figure 8-23 IGCT

8 Prepare the components for reassembly.

Check the contact surfaces of the new IGCT, the cooler and the isolator disk for any dirt. If necessary, clean the contact surfaces with an appropriate solvent (e. g. alcohol). Using a fluff-free cloth wipe the surfaces paying attention not to scratch the surfaces.



Note: Do not use any grease or any electrical joint compound.

- 9** Push the new IGCT into the stack taking care that it slides smoothly along the guiding rails and that the contact surfaces of the semiconductor are not scratched.
- 10** Insert the isolator disk and center it properly.
- 11** Insert the pressure adjusting bolt by hand taking care that the tip of the bolt inserts into the centering hole of isolator disk.
- 12** Adjust the clamp pressure of the stack.
Tighten the pressure adjusting bolt until the clamp pressure loading gauge is released.
- 13** Reconnect the fiber optic and the power supply cable.
- 14** Fasten the gauge in its storage place.
- 15** Power up the drive and confirm its proper functioning.
- 16** If a defective part has to be returned to ABB, particularly if it is still under warranty, follow the procedures as stated in the Warranty Directive (this is recommended even if the warranty period has expired).

Chapter 9 - Changing Thyristors in EXU

9.1 Required Tools and Accessories

The tools listed below are part of the tool set (ident. no. 3BHS130246) delivered with the ACS 6000.

- 1/2 " reversible ratchet
- 13 mm drive socket (EXU for brushless excitation)
- 17 mm drive socket (EXU for direct excitation)
- Deflection gauge
- Sliding caliper
- Cable ties

9.2 Safety

Before starting any work on the EXU do the following:

- 1 Deenergize and ground the ACS 6000.



Danger: The ACS 6000 is a high voltage device.

Make sure that the cabinet has been completely deenergized and that power cannot be applied by accident.

Failure to do so may result in injury or death.



Note: After switching off the mains and after the motor has come to a stop, allow the DC link capacitors to discharge. The light **GND.- SWITCH UNLOCKED** must be on before grounding the ACS 6000.

- 2 Switch off the auxiliary power supply. Refer to the wiring diagrams to identify the circuit breaker.

9.3 Replacing Thyristors in EXUs for Brushless Excitation



Figure 9-1 3-phase AC Power Controller

9.3.1 Preparatory Steps

- 1 Check that the drive has been deenergized and voltages have been removed from the cabinet. See section 9.2 *Safety*.
- 2 Cut off the cable tie securing the thyristor gate wires and remove them from the pulse transformer.
- 3 Loosen the clamp bolts alternately until they can be turned by hand and loosen the thyristor (see *Figure 9-2*). At first, do not open the bolts completely to prevent the clamp from dropping.

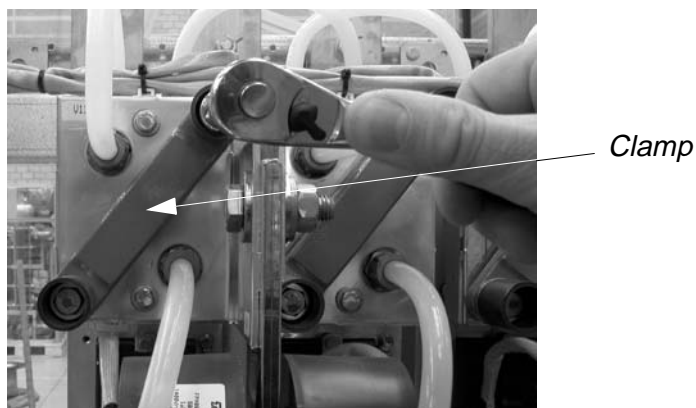

Figure 9-2 Loosening the Bolts

- 4 Open the bolts completely and remove the broken thyristor together **with** the plastic guide.

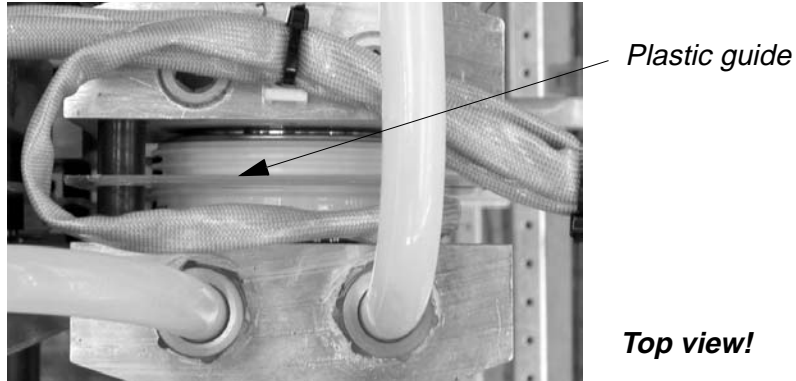

Figure 9-3 Removing a Thyristor

- 5 Remove the plastic guide and the gate wires from the broken thyristor.

9.3.2 Treating a New Thyristor before Installation

- 1 Check the contact surfaces for nicks, scratches, bulges and surface finish (flatness and roughness).
- 2 Connect the gate wires and the plastic guide to the new thyristor.
- 3 Using a nylon sponge, carefully abrade the mating surfaces by applying circular movements. Take special care not to expose the copper when abrading. Wipe the abraded semiconductor surfaces clean with methanol liquid and non-flammable cloth and apply a thin layer of electrically and heat conducting compound (G 322 L) on the mating surfaces using a rubber trowel.

9.3.3 Mounting a New Thyristor

- 1 Push in the semiconductor together with the plastic guide. Pay attention to the right polarity.
- 2 Tighten clamp bolts by hand.
- 3 Using a sliding caliper, verify that the distance between the clamp and the outer cooling element is equal on both sides (see Figure 9-4).

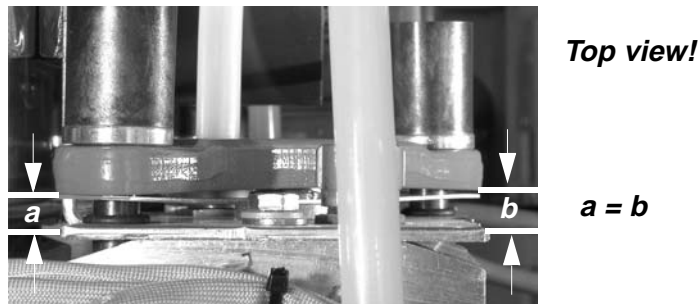

Figure 9-4 Checking the Distances

- 4 Place the deflection gauge in the middle of the clamp (see *Figure 9-5*) and reset the dial to zero.

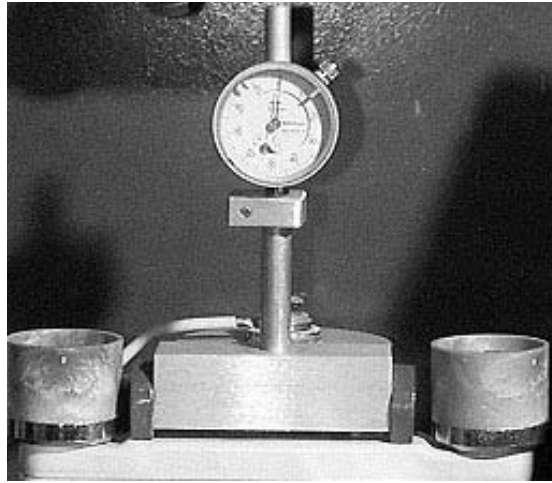

Figure 9-5 Placing the Deflection Gauge

- 5 Tighten both bolts alternately, first turning them half a turn each, then less, until the desired compression force is reached (see *Figure 9-9* for the correct value).
- 6 Connect the gate wires to the pulse transformer.
- 7 Fasten the gate wires with a cable tie.
- 8 If a defective part has to be returned to ABB, particularly if it is still under warranty, follow the procedures as stated in the Warranty Directive (this is recommended even if the warranty period has expired).

9.4 Replacing Thyristors in EXUs for Direct Excitation

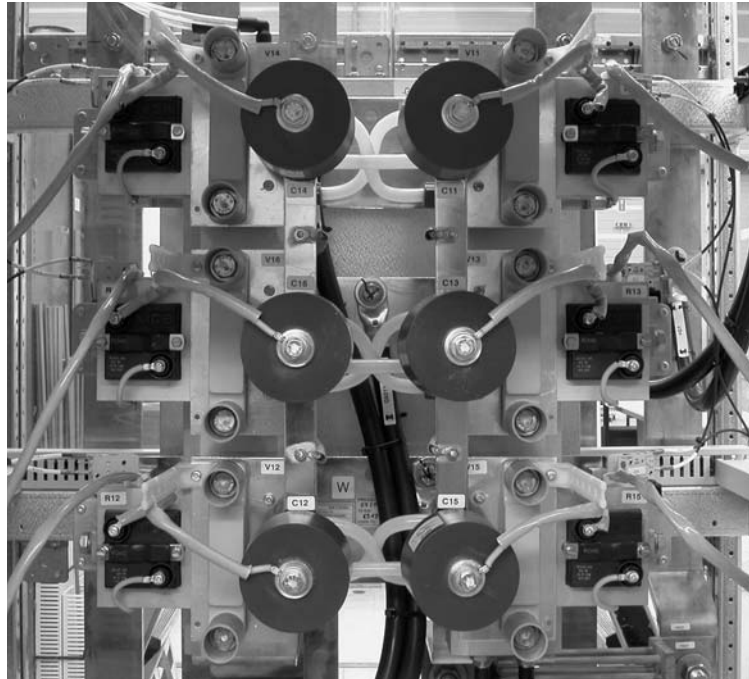

Figure 9-6 6-pulse Thyristor Rectifier

9.4.1 Preparatory Steps

- 1 Deenergize the drive. See section 9.2 Safety.
- 2 Remove the fuse and the fuse support in order to be able to remove the thyristor (see Figure 9-8). Cut off the cable tie securing the thyristor gate wires and remove them from the pulse transformer.
- 3 Loosen the clamp bolts alternately until they can be turned by hand and loosen the thyristor (see Figure 9-7). To prevent the clamp from dropping, do not open the bolts completely.

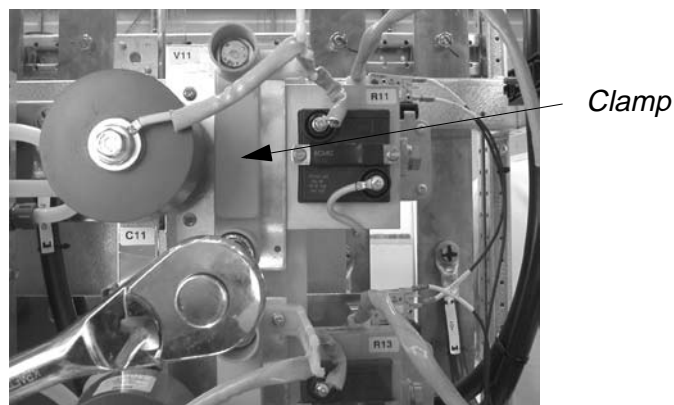

Figure 9-7 Loosening the Bolts

- 4 Pull the broken thyristor **out of** the plastic guide.

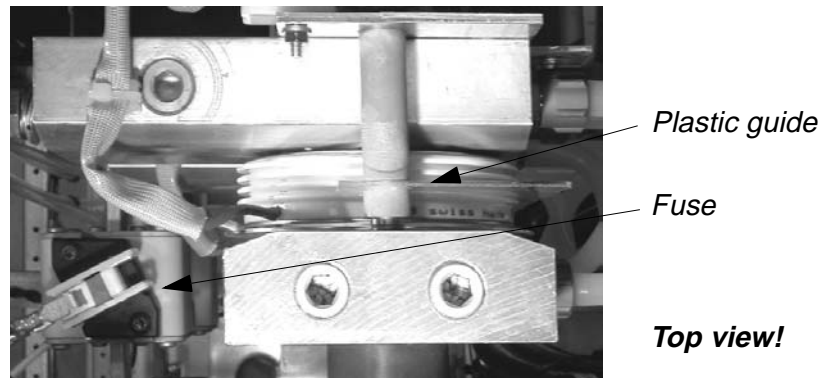

Figure 9-8 Removing a Thyristor

- 5 Remove the gate wires from the broken thyristor.

9.4.2 Treating a New Thyristor before Installation

- 1 Check the contact surfaces for nicks, scratches, bulges and surface finish (flatness and roughness).
- 2 Connect the gate wires to the new thyristor.
- 3 Using a nylon sponge, carefully abrade the mating surfaces by applying circular movements. Take special care not to expose the copper when abrading. Wipe the abraded semiconductor surfaces clean with methanol liquid and non-flammable cloth and apply a thin layer of heat-conducting compound (G 322 L) on the mating surfaces with a rubber trowel.

9.4.3 Mounting a New Thyristor

- 1 Push the semiconductor into the plastic guide.
Pay attention to the right polarity.
- 2 Tighten clamp bolts by hand.
- 3 Using a sliding caliper, verify that the distance between the deflection bar and the outer cooling element is equal on both sides (see *Figure 9-4*).
- 4 Place the deflection gauge in the middle of the clamp (see *Figure 9-5*) and reset the dial to zero.
- 5 Tighten both screws alternately, first turning them half a turn each, then less, until the desired compression force is reached (see *Figure 9-9* for the correct value).
- 6 Connect the gate wire to the pulse transformer.
- 7 Fasten the gate wires with a cable tie.
- 8 If a defective part has to be returned to ABB, particularly if it is still

under warranty, follow the procedures as stated in the Warranty Directive (this is recommended even if the warranty period has expired).

9.5 Deflection Diagram

*Direct excitation 5STP 1842H
Clamp type SLZD 117
Force 45 kN
Deflection 0.103 mm
Meas. device code 57269324*

*Brushless excitation 5STP 1242F
Clamp type SLZF 117
Force 22 kN
Deflection 0.121 mm
Meas. device code 57269324*

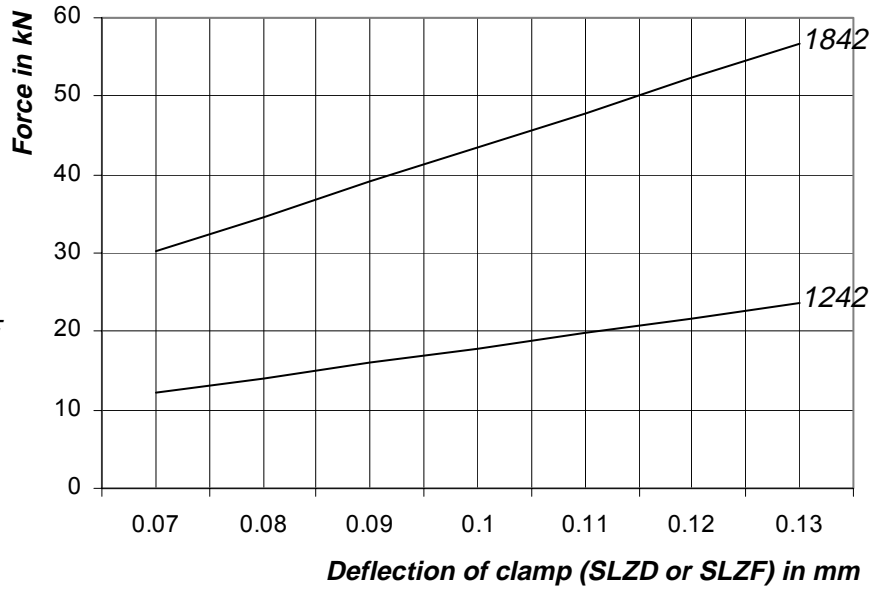

Figure 9-9 Deflection Diagram

Chapter 10 - Changing Semiconductors in VLU

10.1 Required Tools and Accessories

The tools listed below are part of the tool set (ident. no. 3BHS130246) delivered with the ACS 6000.

- 1/2 " reversible ratchet
- 12 mm 1/2" hex socket
- 10 mm ring spanner
- 5 mm hex key

10.2 Safety

Before starting any work on the VLU do the following:

- 1 Deenergize and ground the ACS 6000.



Danger: The ACS 6000 is a high voltage device.

Make sure that the cabinet has been completely deenergized and that power cannot be applied by accident.

Failure to do so may result in injury or death.



Note: After switching off the mains and after the motor has come to a stop, allow the DC link capacitors to discharge. The light **GND.- SWITCH UNLOCKED** must be on before grounding the ACS 6000.

- 2 Switch off the auxiliary power supply. Refer to the wiring diagrams to identify the circuit breaker.

10.3 Replacing the Semiconductors

10.3.1 Preparatory Steps

- 1 Check that the drive has been deenergized and voltages have been removed from the cabinet. See section *10.2 Safety*.
- 2 Slide the pressure loading gauge under the clamp ring of the pressure adjusting bolt and remove the bolt to release the clamp pressure of the stack using the 12 mm 1/2" hex socket from the tool box

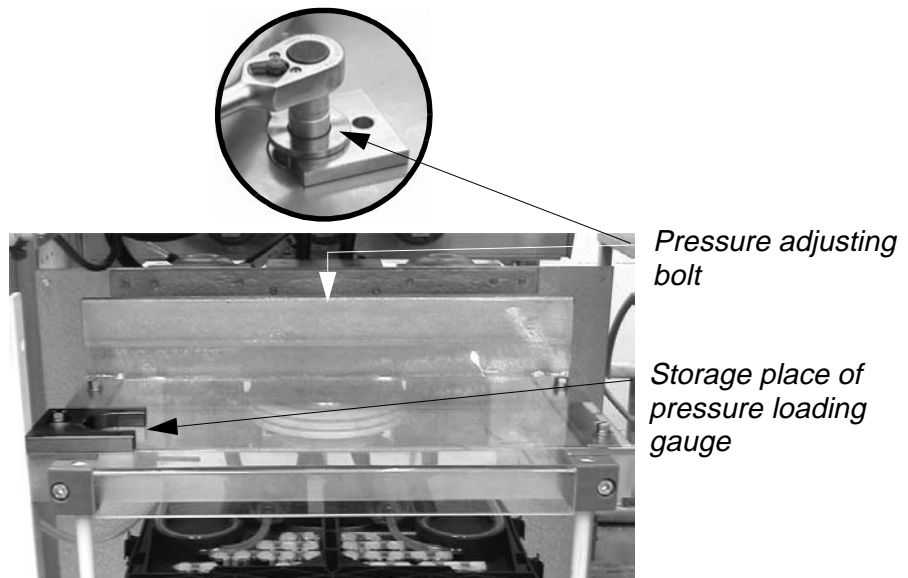

Figure 10-1 Top View of VLU

10.3.2 Replacing Upper Diode

In order to replace the upper diode only the clamp pressure of the stack must be released. The retaining rods of the IGCTs (see *Figure 10-4*) can stay in place.

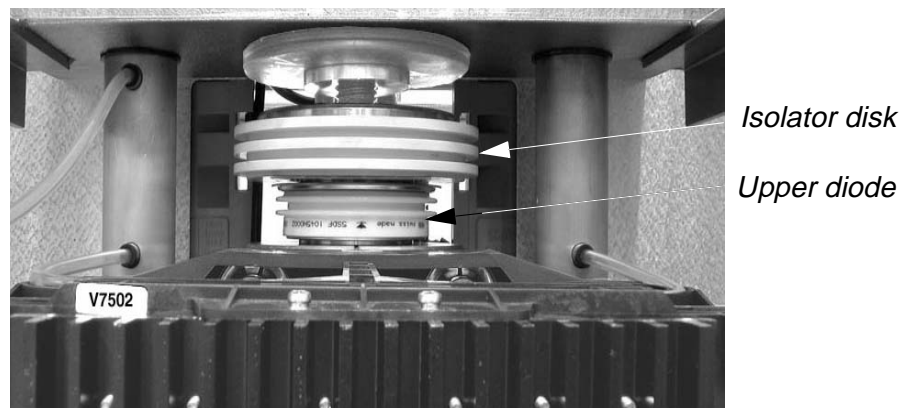

Figure 10-2 Upper Diode

- 1 Remove the isolator disk above the diode and pull the diode out.
- 2 Continue with section 10.3.5 *Finishing Steps*, step 1.

10.3.3 Replacing IGCTs

- 1 Disconnect fiber optic cable and the power supply lead of the IGCT to be replaced (see arrows in *Figure 10-3*).

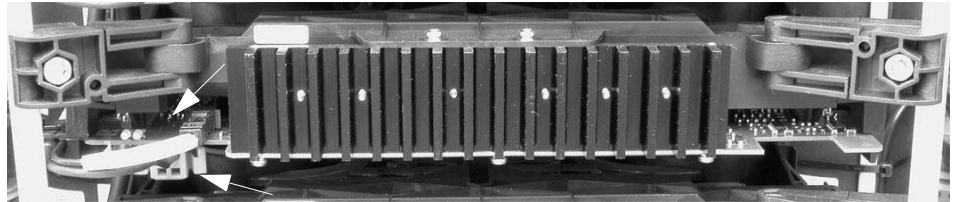
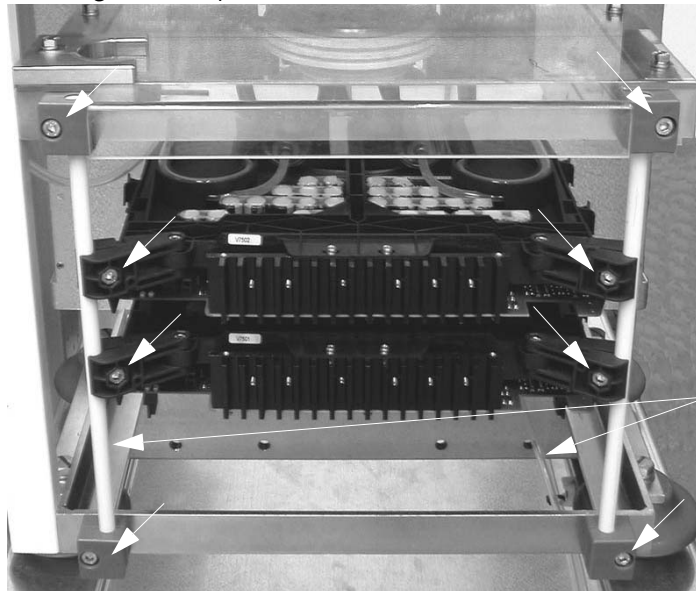

Figure 10-3

- 2 Loosen the hexagon fastening bolts of the IGCTs (see arrows in *Figure 10-4*).



Retaining rods

Figure 10-4

- 3 Pull down the retaining rods until the faulty IGCT is free.

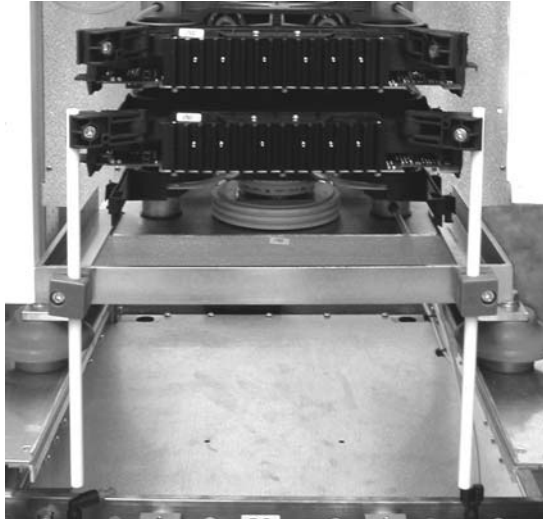

Figure 10-5

- 4 Remove the isolator disk and the diode above the IGCT.
- 5 Pull out the faulty IGCT.
- 6 In case the new IGCT is not fitted with retaining clamps and guides (see Figure 10-6) remove these parts from the faulty IGCT and mount them on the new IGCT.

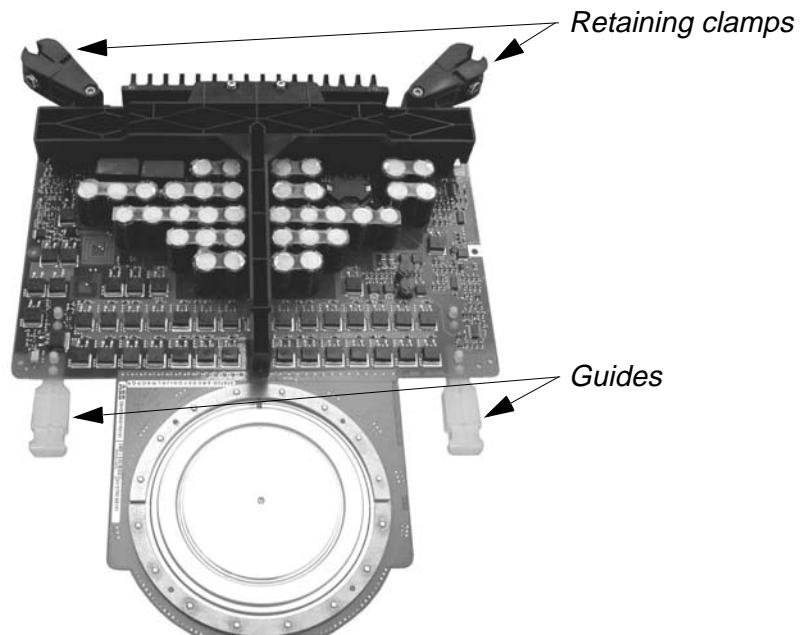

Figure 10-6 IGCT

- 7 Continue with section 10.3.5 *Finishing Steps*, step 1.

10.3.4 Replacing Lower Diode

When only one person replaces the lower diode it is recommended to remove all components in the stack above the diode (except the cooling elements). Doing it like this, the components above the diode do not have to be pushed up with one hand while at the same time the new diode is placed in the stack and centered with the other hand.

- 1 Remove the isolator disk, the upper diode and the IGCTs as described in sections *10.3.2 Replacing Upper Diode* and *10.3.3 Replacing IGCTs*.
- 2 Continue with *10.3.5 Finishing Steps*, step 1.

10.3.5 Finishing Steps

After the new component has been inserted into the stack proceed as follows:

- 1 Thoroughly clean the contact surfaces of the new semiconductor and the adjacent components with an appropriate solvent (e.g. alcohol). Using a fluff-free cloth wipe the surfaces paying attention not to scratch the surfaces.



Note: Do not use any grease or any electrical joint compound.

- 2 Place the component(s) in the stack. Pay attention to the correct polarity.
- 3 Check that all components in the stack are properly centered before adjusting the clamp pressure. Pay attention that the center ball of a diode and the plastic guides of an IGCT are properly inserted into their counterparts.
- 4 When starting to tighten the pressure adjusting bolt make sure that it inserts properly into the center hole of the upper clamping disk.

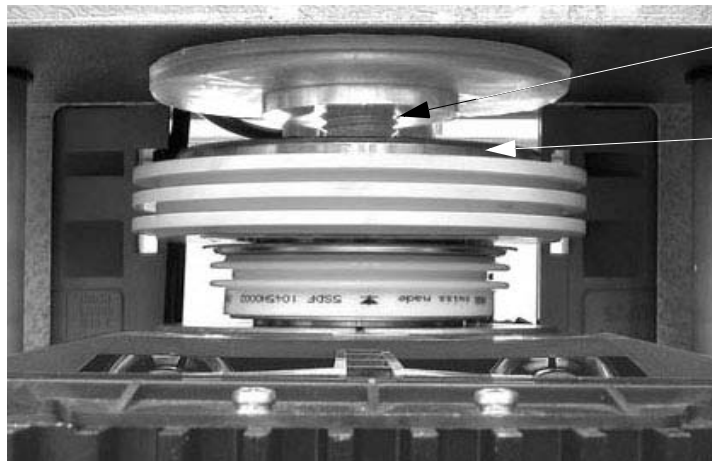

Pressure adjusting bolt
Clamping disk

Figure 10-7 Upper Part of VLU Stack

- 5 Tighten the pressure adjusting bolt until the clamp pressure loading gauge is released
- 6 Refit the clamp loading gauge in its storage place.
- 7 If a defective part has to be returned to ABB, particularly if it is still under warranty, follow the procedures as stated in the Warranty Directive (this is recommended even if the warranty period has expired).

Chapter 11 - Changing IGBTs in DIU

11.1 Required Tools and Accessories

The tools listed below are part of the tool set (ident. no. 3BHS130246) delivered with the ACS 6000.

- 1/2 " reversible ratchet
- 24 mm socket
- 10 mm socket
- Cable ties

11.2 Safety

Before starting any work on the DIU do the following:

- 1 Deenergize and ground the ACS 6000.



Danger: The ACS 6000 is a high voltage device.

Make sure that the cabinet has been completely deenergized and that power cannot be applied by accident.

Failure to do so may result in injury or death.



Note: After switching off the mains and after the motor has come to a stop, allow the DC link capacitors to discharge. The light **GND.- SWITCH UNLOCKED** must be on before grounding the ACS 6000.

- 2 Switch off the auxiliary power supply. Refer to the wiring diagrams to identify the circuit breaker.

11.3 Removing an IGCT

The DIU is located in the bottom left corner of a CBU. The CBU is available in two different sizes depending on the power rating of the converter (size 1 for converters up to 9 MVA and size 2 for converters rated for 9 to 14 MVA).

The replacement of IGCTs is explained using the example of size 1 of the CBU. Although the space in this type of CBU is very narrow the IGCTs can be replaced from the front of the cabinet.

- 1 Check that the drive has been deenergized and voltages have been removed from the cabinet. See section 11.2 *Safety*.
- 2 Disconnect the fiber optic cable (see *Figure 11-1*) and the power supply lead (not shown in *Figure 11-1*) of the IGCT to be replaced.

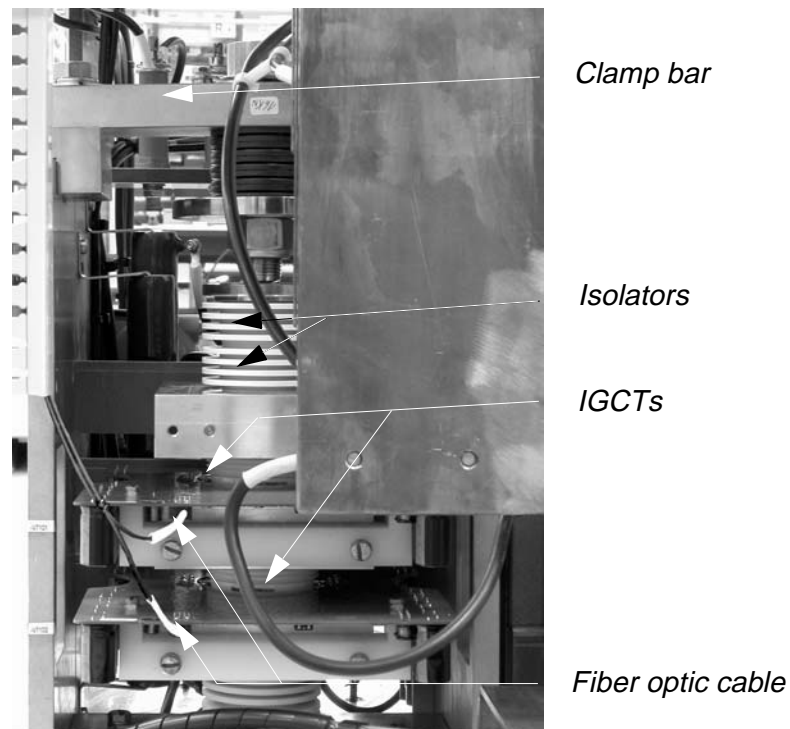

Figure 11-1 Front View of DIU

- 3 Take off the clamp head to release the clamp pressure.

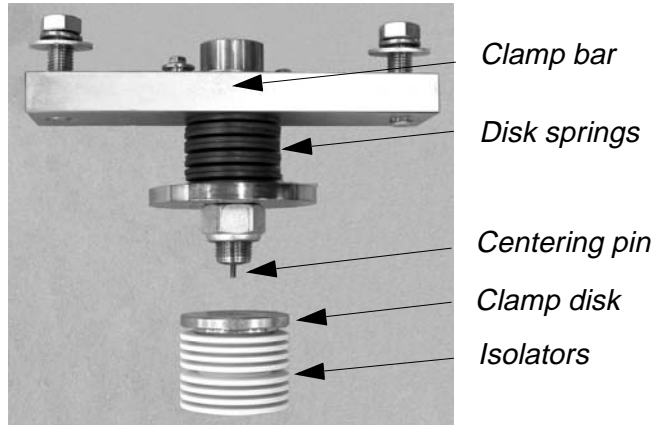
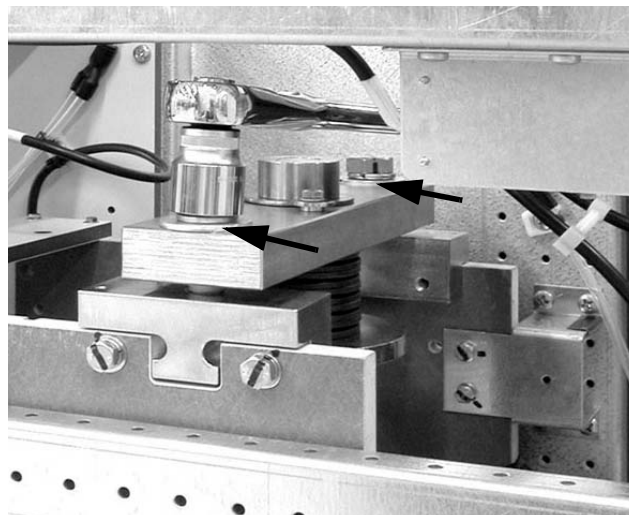

Figure 11-2 Clamp Head

The clamp head is fairly heavy and the DIU is not very well accessible particularly if installed in small CBUs. Due to the narrow space it is difficult to remove an IGCT while at the same time pushing up the components located above. Therefore it is recommended to remove the clamp head to facilitate work.

The clamp disk and the isolators below the disk springs of the clamp head can also only be removed after the clamp head has been taken off. If the clamp head is not removed or pushed up far enough the centering pin below the disk springs will prevent the removal of clamp disk and isolators.

The fixing bolts (see arrows in *Figure 11-3*) of the clamp bar require a 24 mm socket.



Clamp head seen from the side. This view is not possible in a line-up.

Figure 11-3 Fastening Bolts

- 4 Remove the fastening bolts of the IGCT. The bolts require a 10 mm socket.

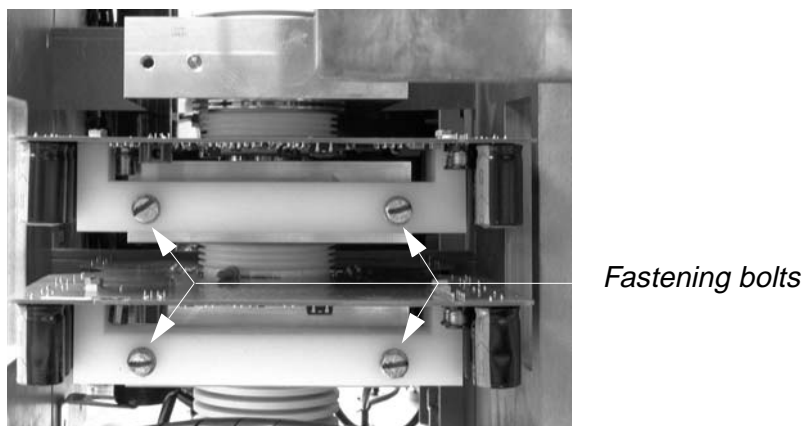

Figure 11-4 Fastening Bolts

- 5 Remove the faulty IGCT.

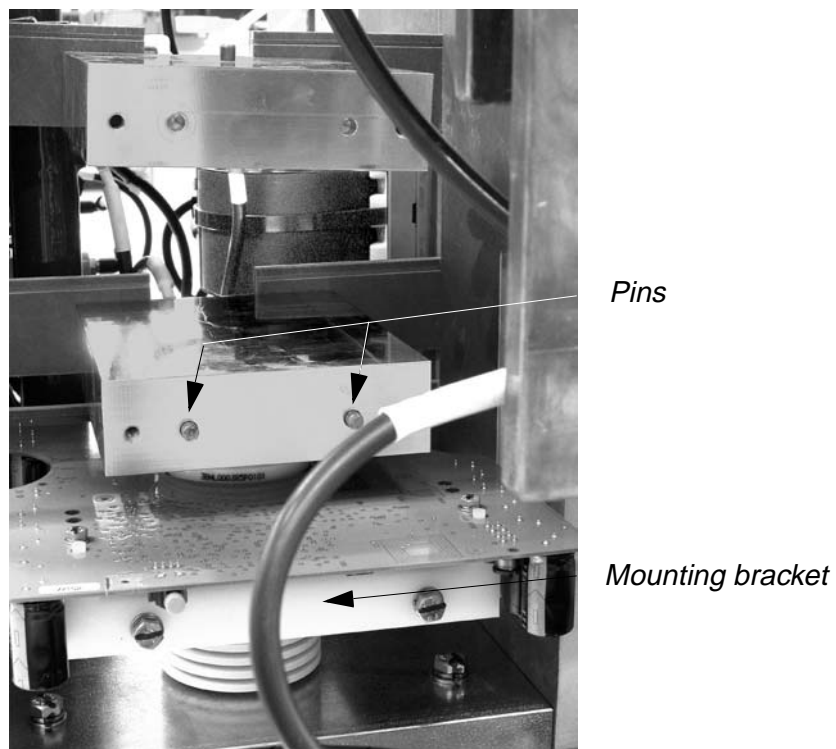

Figure 11-5 IGCT Removed

11.4 Installing an IGCT

- 1 In case the new IGCT is not fitted with a mounting bracket (see *Figure 11-5*) remove this part from the faulty IGCT and mount it on the new IGCT.
- 2 Thoroughly clean the contact surfaces of the new semiconductor and the adjacent components with an appropriate solvent (e.g. alcohol). Using a fluff-free cloth wipe the surfaces paying attention not to scratch the surfaces.



Note: Do not use grease or an electrical joint compound.

- 3 Push the IGCT into place.
The two pins on the cooler must insert properly into the holes of the mounting bracket of the IGCT (see *Figure 11-5*).
- 4 Reinstall the components above the IGCT.
- 5 Adjust the clamping pressure.
Tighten the bolts alternately by one turn at a time until the clamping pressure is adjusted.
The clamping pressure is properly adjusted if the two indicating washers are level with the reference ring (see circles in *Figure 11-6*).

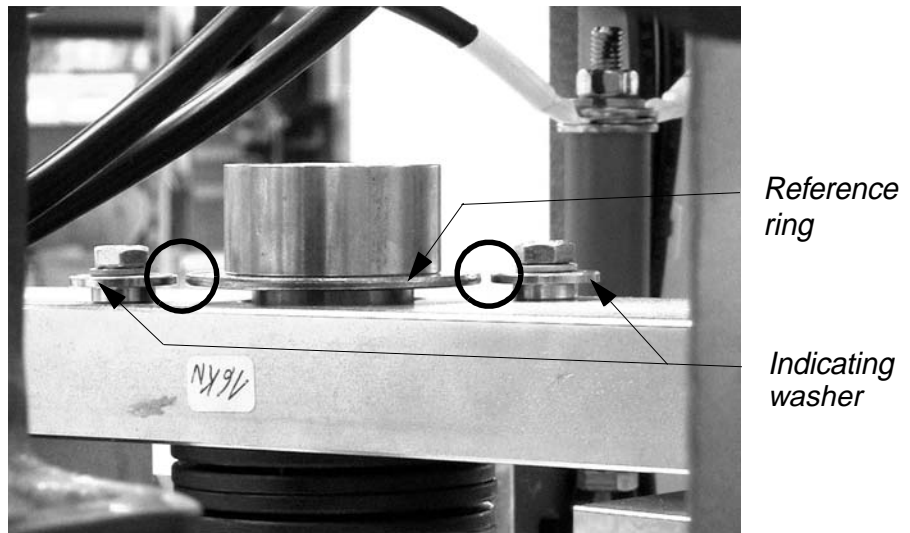

Figure 11-6 Adjusting the Clamping Pressure

- 6 If a defective part has to be returned to ABB, particularly if it is still under warranty, follow the procedures as stated in the Warranty Directive (this is recommended even if the warranty period has expired).



Chapter 12 - Replacing Printed Circuit Boards

12.1 Safety



- 1 Deenergize and ground the ACS 6000.

Danger: The ACS 6000 is a high voltage device.

Make sure that the cabinet has been completely deenergized and that power cannot be applied by accident.

Failure to do so may result in injury or death.



Note: After switching off the mains and after the motor has come to a stop, allow the DC link capacitors to discharge. The light **GND.- SWITCH UNLOCKED** must be on, before grounding the ACS 6000.

- 2 Switch off the auxiliary power supply. Refer to the wiring diagrams to identify the circuit breaker.



Note: Do not touch printed circuit boards or other sensitive components without applying static-sensitive handling precautions!

Static electricity can damage boards and components!

- Do not touch the components without wearing a properly grounded wrist.
 - Put the board or component on a grounded working surface protected against electrostatic discharges.
 - Hold a board only at the edge.
 - Handle a faulty board as carefully as a new one.
-



Note: Handle fiber optic cables with care.

Do not touch the ends of the fibers, they are extremely sensitive to dirt. Always hold the connector when unplugging a fiber optic cable.

Fiber optic cables can be damaged if bent sharply. Observe the minimum bend radius of **25 mm**.

AMC3 boards are mounted inside a COU cabinet. Depending on the layout of the COU the fitting position of the board is on the swing frame (see *Figure 12-2 a, b*) or on the door of the cabinet (see *Figure 12-2 b*).

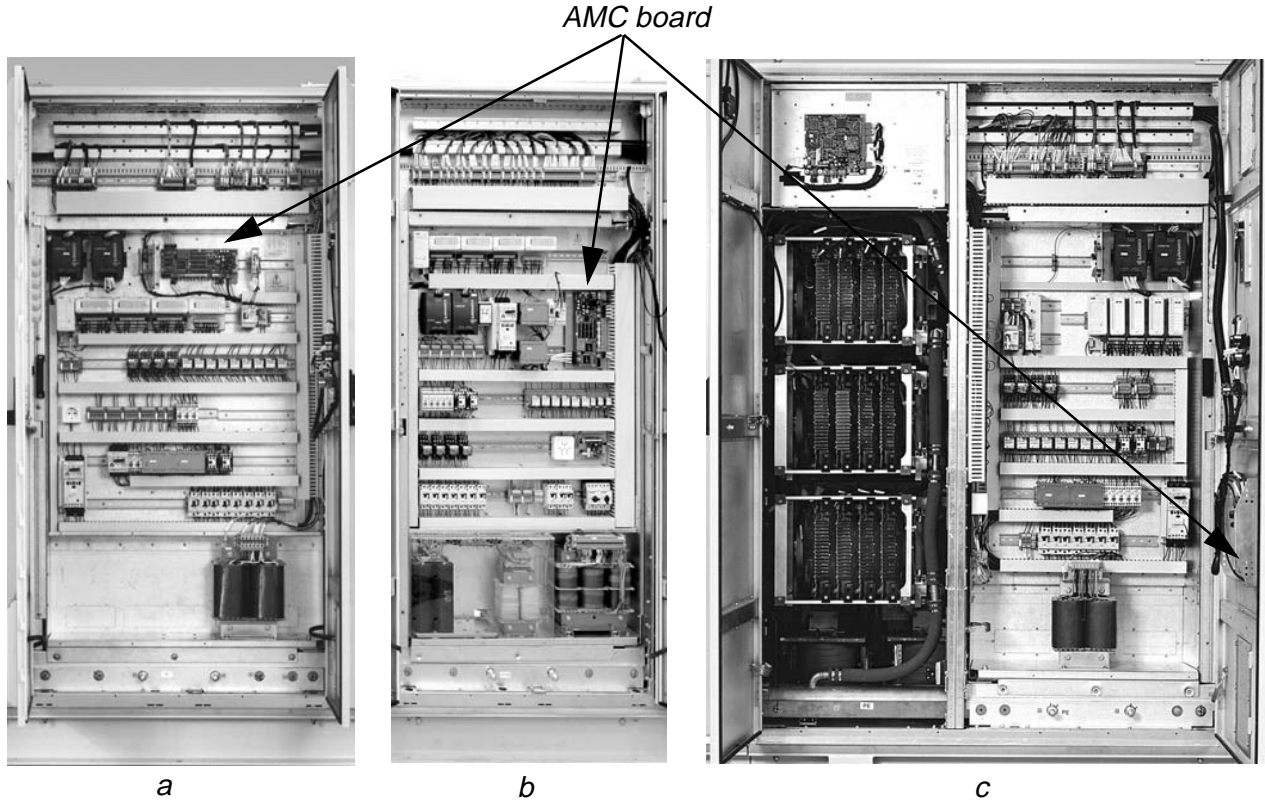

Figure 12-2 Fitting Position of AMC3 Boards

- 1** Before touching the AMC3 board ground yourself at the converter frame with a wrist strap.
- 2** Remove the power and ground the ACS 6000 according to section *Chapter 1 - Introduction and Safety*
- 3** Unplug the fiber optic cables, the power supply connector and the control panel connector.
- 4** Remove the fastening screws (7 pcs.) and the AMC3 board.
- 5** Take all necessary precautions to prevent screws and washers falling into other components.
- 6** Before mounting the new AMC3 board verify:
 - the boot prom version
 - that the SW version and the parameter settings correspond to those of the converter.

- 7 Attach the new AMC3 board.



Note: It is important that all fastening screws are used to ensure proper grounding of the board.

- 8 Reconnect the fiber optic cables, the power supply connector and the control panel connector.
- 9 Verify the connections by comparing them with the corresponding wiring diagram.
- 10 Put the defective board in an antistatic bag.
- 11 Power up the drive and confirm its proper functioning.
- 12 If the defective board has to be returned to ABB, particularly if the component is still under warranty, follow the procedures as stated in the Warranty Directives (this is recommended even if the warranty has expired).

12.3 Changing the AMC3 Flash Memory

The application control software and the parameter settings are saved in the flash memory which is on a separate printed circuit board (PCB). When the AMC3 board is replaced the old flash memory can still be used if the software has not been upgraded.

- 1 Remove the power and ground the ACS 6000 according to section 12.1 Safety.

If only the flash memory has to be replaced the AMC3 board can remain in the cabinet. It is also not necessary to disconnect the fiber optic cables.

- 2 Note the orientation of the white dot on the board for later reference before removing the flash memory PCB.

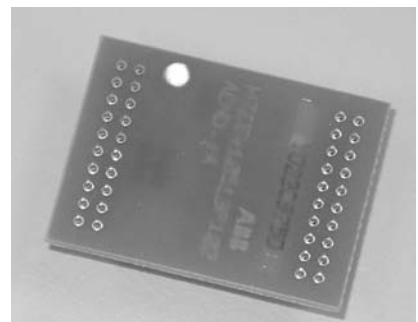
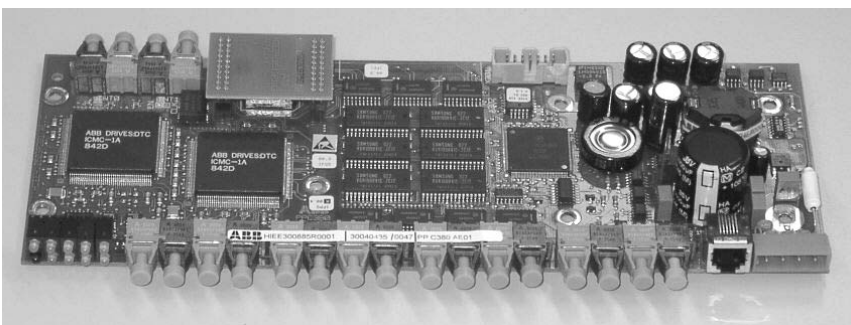

Figure 12-3 AMC3 Board (a) and Flash Memory PCB (b)

- 3 Remove the flash memory PCB by holding it with both hands and pulling it at a 90° angle away from the AMC board.

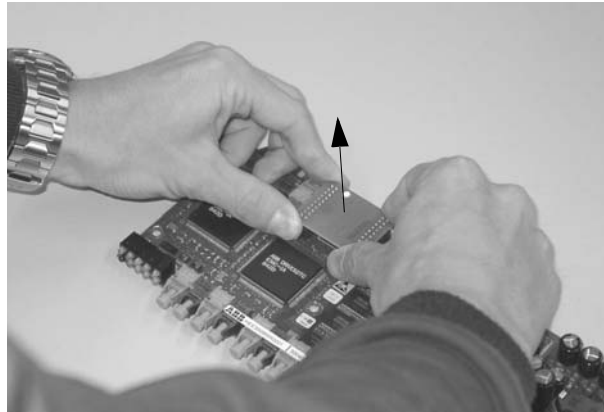

Figure 12-4 Removing the Flash Memory PCB

- 4 When attaching the new PCB make sure that the white dot on the PCB is on top of that on the AMC3 board (see Figure 12-5).



Note: Correct orientation of the new PCB is important. If attached wrongly the new PCB will be damaged immediately when the auxiliary power is switched on.

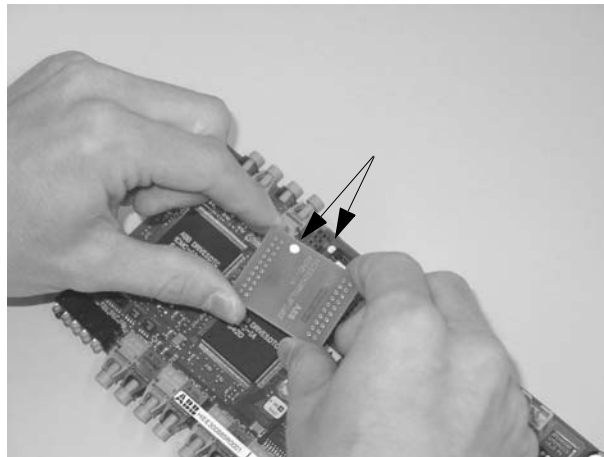

Figure 12-5 Attaching the Flash Memory PCB

Press the PCB firmly down making sure that all pins are inserted properly.

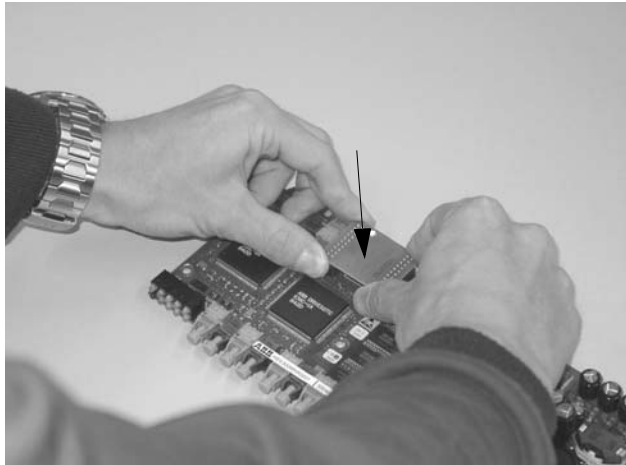

Figure 12-6 Inserting the New Flash Memory PCB

- 5** Put the defective board into an antistatic bag.
- 6** Power up the drive and confirm its proper functioning.
- 7** If the defective board has to be returned to ABB, particularly if the component is still under warranty, follow the procedures as stated in the Warranty Directives (this is recommended even if the warranty period has expired).

12.4 Replacing an INT Board

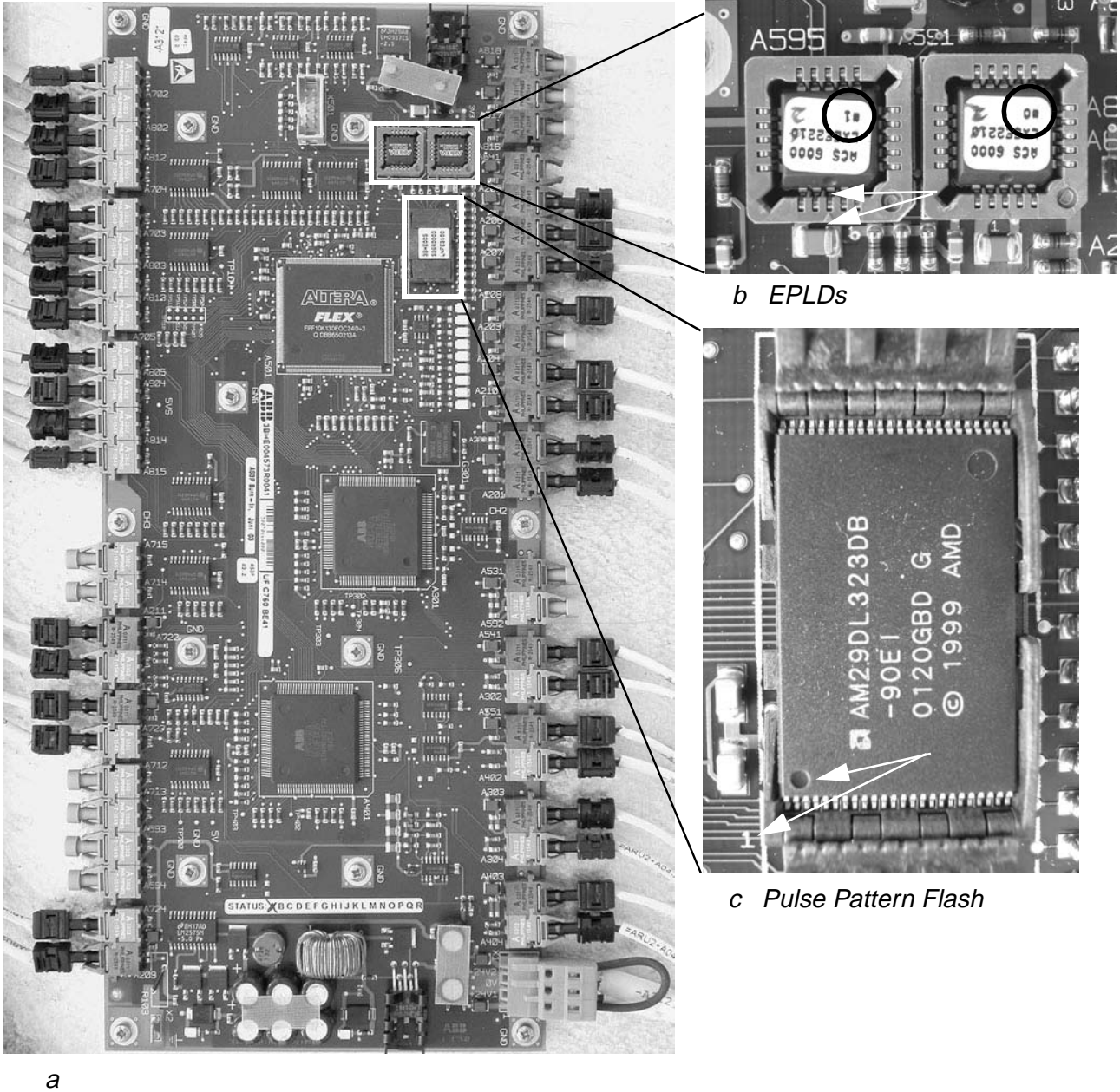
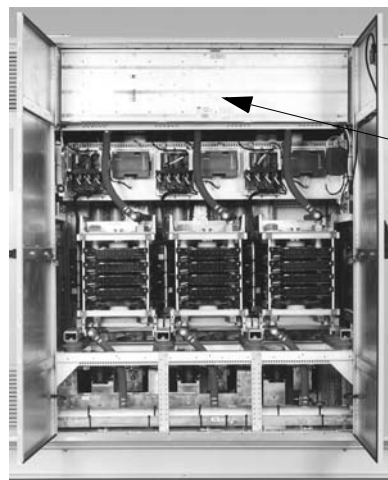

Figure 12-7 INT Board

Depending on the configuration of the ACS 6000, INT boards are located in the following cabinets:

- ARU
The INT board is mounted on the back side of the hinged cover in the top section of the ARU cabinet. To access the board the cover needs to be opened. See *Figure 12-8*.
- INU
In converters with power ratings above 7 MVA, the mount is the same as in an ARU. See *Figure 12-8 a*.

In 3/5 MVA converters, the INT board is also mounted on the back side of the hinged cover. See *Figure 12-8 b*.



a ARU/INU for Power Ratings > 7MVA

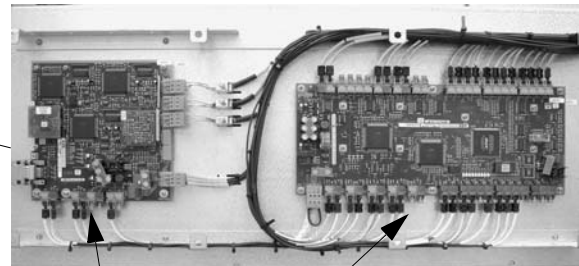

CVMI board and INT board behind cover

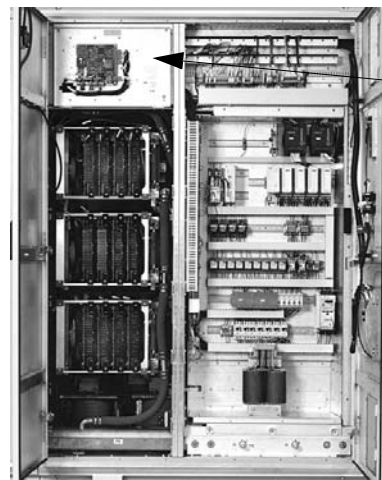

b INU for 3/5 MVA Converters

INT board behind cover

Figure 12-8 Location of INT Board in ARU and INU

- COU
Figure 12-9 shows the INT board installed on the back side of the right front door. Depending on the layout of the cabinet and the configuration of the ACS 6000 the board can be mounted in a different position.

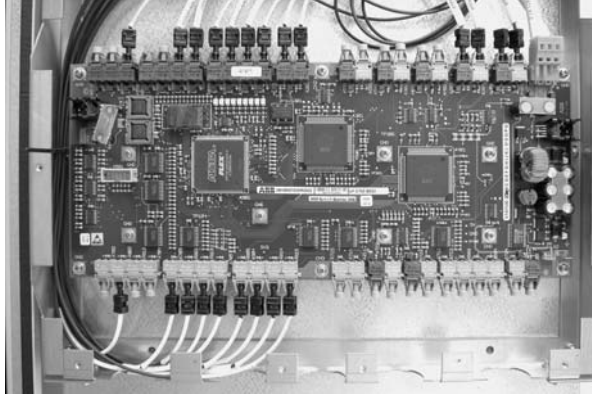

Figure 12-9 Location of INT Board in COU

- 1 Before touching the INT Board ground yourself at the converter frame with a wrist strap.
- 2 Remove the power and ground the ACS 6000 according to section *12.1 Safety*.
- 3 Unplug the fiber optic cables and the power supply connector.
- 4 Remove the fastening screws (13 pcs).
 Take all necessary precautions to prevent screws and washers falling into other components.
- 5 Remove the INT board and place it on a grounded working surface protected against electrostatic discharges to transfer the EPLD chip and if necessary the Pulse Pattern Flash to the new INT board. The location of the memory chips can be seen in *Figure 12-7*.
- 6 Transfer the memory chips.
- 7 Depending on the cabinet the INT board has been removed from the following memory chips have to be transferred from the faulty to the new board:
 - **EPLD Chip** and **Pulse Pattern Flash** if INT board was installed in an ARU,
 - **EPLD Chip** if INT board was installed in an INU or COU (INT boards used in INUs or COUs have no Pulse Pattern Flash).

Transferring the EPLD Chips

- 1 Put the new INT board next to the board being replaced.
- 2 Extract the EPLD chip using an appropriate tool.
- 3 When inserting the EPLD chip into the new INT board pay attention to the orientation and the allocation of the chips. The dot on the chip must be aligned with the arrow on the socket (see arrows in *Figure 12-7 b*). Allocate the EPLDs according to the numbers on the labels (see circles in *Figure 12-7 b*).



Note: Correct orientation of the EPLD chip is important. If attached wrongly it will be damaged.

Transferring the Pulse Pattern Flash

- 1 Unlock the cover of the flash socket by pushing the middle section away from the notch (see arrows in *Figure 12-10 b*).

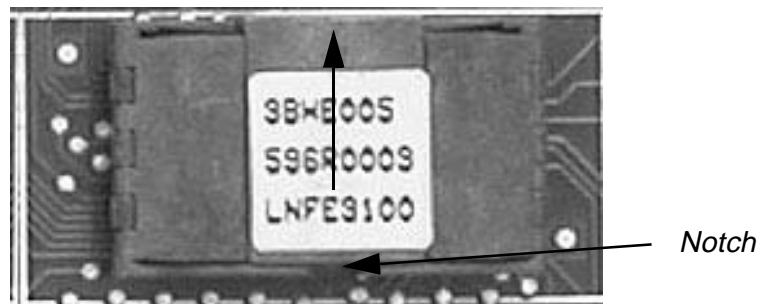

Figure 12-10 Pulse Pattern Flash Cover

- 2 Flip open the halves of the cover and extract the flash with an appropriate tool.
- 3 When inserting the flash into the new INT board pay attention to the orientation of the chip.

The chip must be orientated as shown in *Figure 12-7 c*. The dot on the chip must be next to the "1" on the board.



Note: Correct orientation of the Pulse Pattern Flash is important to ensure proper functioning of the drive.

- 8 In case the EPLDs have been updated with new software, the labels on the chips have to be changed accordingly.

- 9 Mount the new INT board using all fastening screws.



Note: Use all fastening screws to ensure proper grounding of the board.

- 10 Reconnect the fiber optic cables and the power supply connector.
- 11 Carry out a visual check and verify the connections by comparing them with the corresponding wiring diagram.
- 12 Put the defective board into an antistatic bag.
- 13 Power up the drive and check the version number of the EPLDs and the Pulse Pattern Flash (if applicable, see step 7) using *DriveWindows*.
- 14 Confirm the proper functioning of the drive.
- 15 If the defective board has to be returned to ABB, particularly if the component is still under warranty, follow the procedures as stated in the Warranty Directives (this is recommended even if the warranty period has expired).

12.5 Replacing a CVMI Board

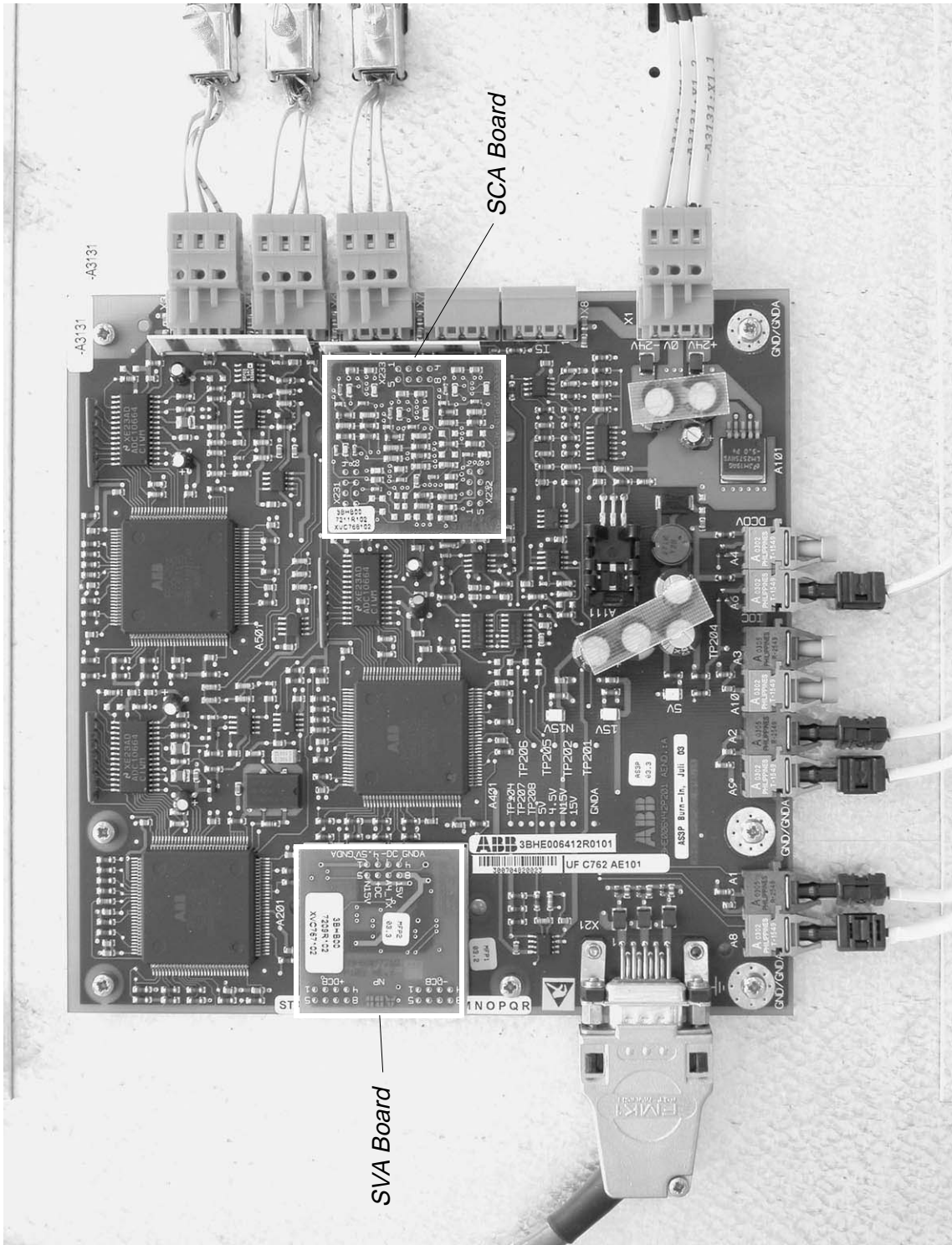

Figure 12-11 CVMI Board

CVMI Boards are installed in the following cabinets:

- ARU
- INU

In converters with power ratings above 7 MVA, the CVMI board is mounted on the back side of the hinged cover of the cable duct in the top section of the ARU cabinet. To access the board the cover must be opened. See *Figure 12-8*.

In 3/5 MVA converters the CVMI board is mounted on the front of the hinged cover. See *Figure 12-12*.

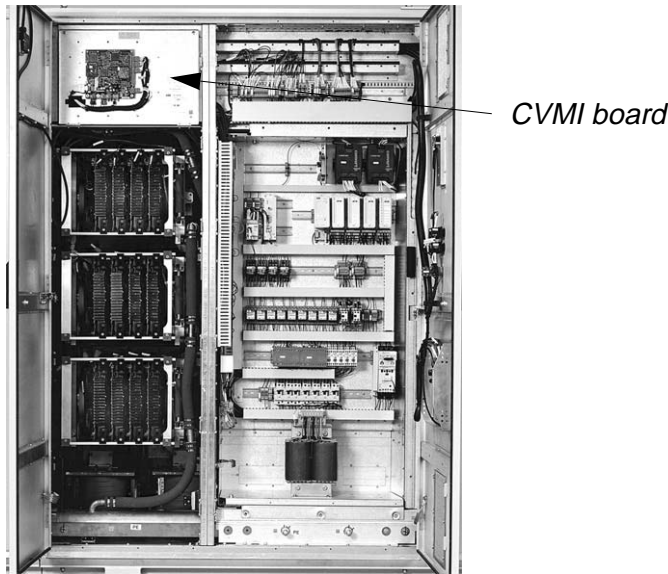

Figure 12-12 Location of CVMI Board in 3/5 MVA Converters

- 1 Before touching the CVMI board ground yourself at the converter frame with a wrist strap.
- 2 Remove the power and ground the ACS 6000 according to section *12.1 Safety*.
- 3 Unplug the fiber optic cables and all other connectors.
- 4 Remove the fastening screws (7 pcs).
Take all necessary precautions to prevent that screws and washers fall into other components.
- 5 Remove the CVMI board and place it on a grounded working surface protected against electrostatic discharges to transfer the SVA and SCA board to the new CVMI board. The location of the printed circuit boards can be seen in *Figure 12-11*.
- 6 Remove the sub-boards and install them on the new board.
- 7 Attach the new CVMI board with all fastening screws.
- 8 Reconnect all cables.

- 9** Verify the connections by comparing them with the corresponding wiring diagram.
- 10** Put the defective board into an antistatic bag.
- 11** Power up the drive and confirm its proper functioning.
- 12** If the defective board has to be returned to ABB, particularly if the component is still under warranty, follow the procedures as stated in the Warranty Directives (this is recommended even if the warranty period has expired).

13.1 AMC Board

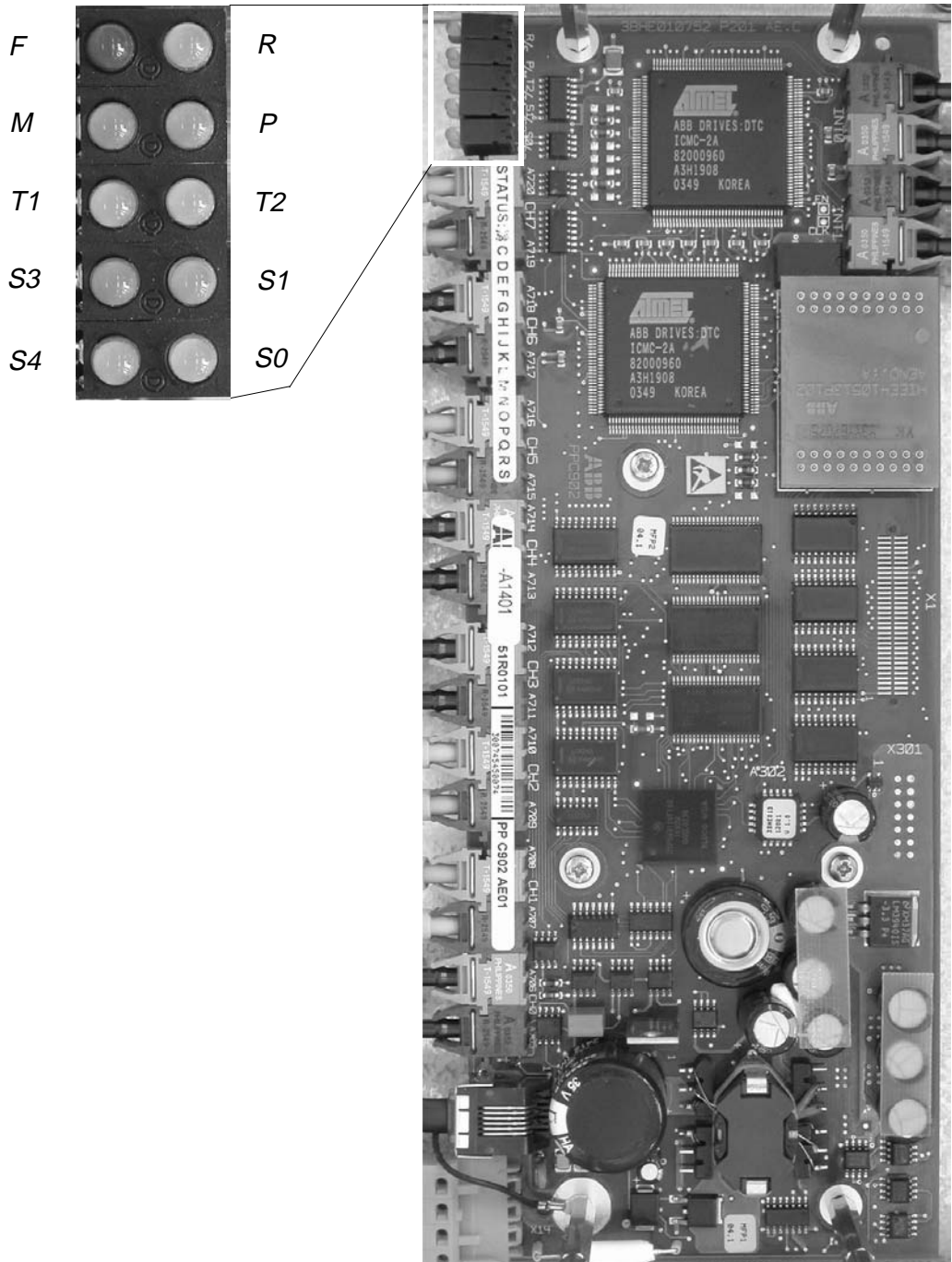

Figure 13-1 AMC3 Board

Table 13-1 LEDs

LED	LED Color	Function
Run	green	Always OFF
Fault	red	Not used (ON when booting)
P	green	Supply OK
M	green	Not used (ON when booting)
T1	yellow	ON = receiving data on DDCS channel 0
T2	yellow	ON = receiving data on DDCS channel 3
S0	yellow	Always OFF
S1	yellow	Always OFF
S2	yellow	Always OFF
S3	yellow	Always OFF

13.2 INT Board

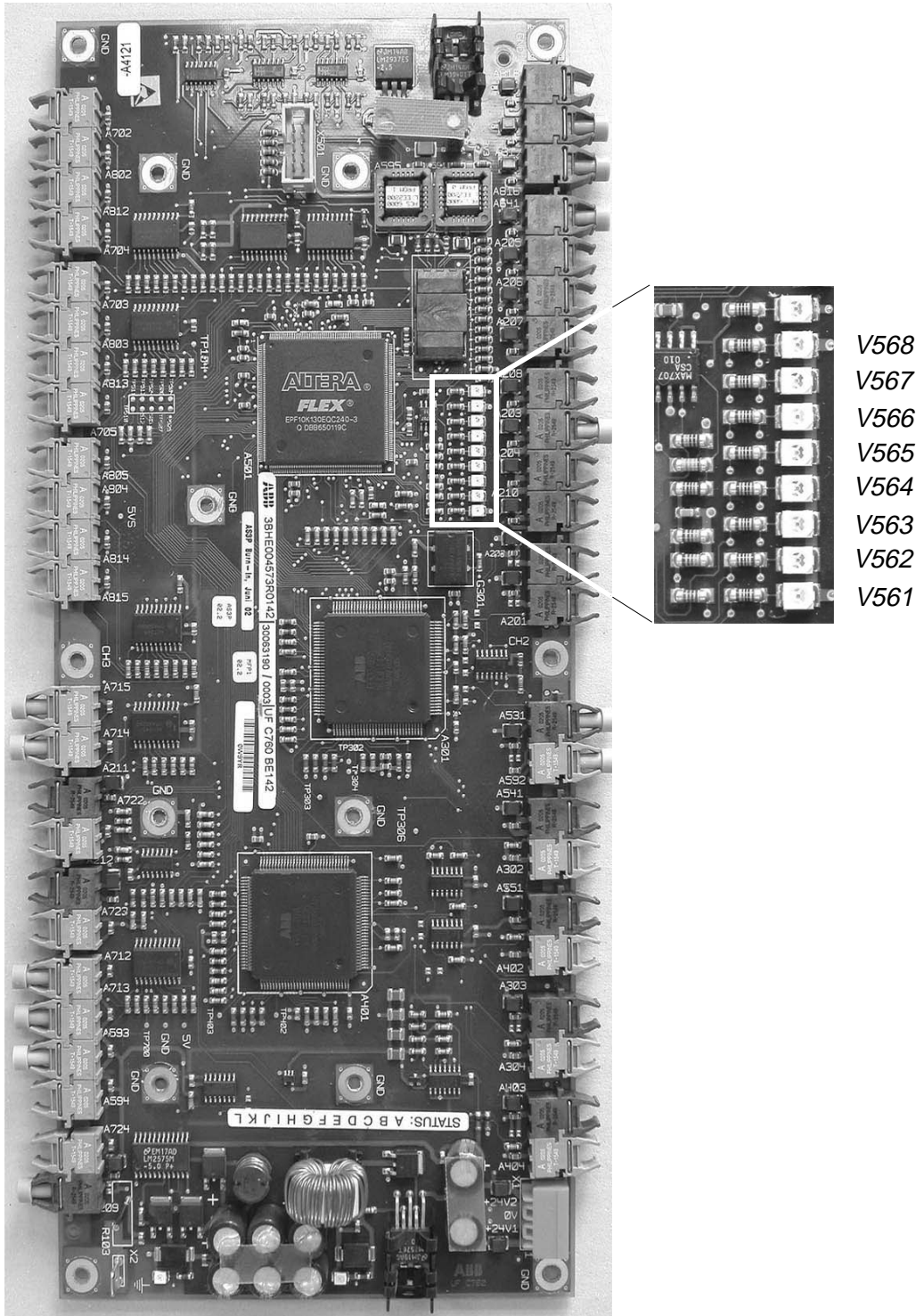

Figure 13-2 INT Board

Table 13-2 LEDs of INT Board in ARU

LED	LED Color	Function
Y561	yellow	Always OFF
Y562	yellow	ON = ARU modulating
Y563	yellow	ON = tripped
Y564	yellow	ON = tripped, MCB is opened
Y565	yellow	ON = removal of pulses in progress or finished
Y566	yellow	ON = firing through in progress or finished
Y567	yellow	ON = ROM bit
Y568	yellow	ON = ASE logic active

Table 13-3 LEDs of INT Board in INU

LED	LED Color	Function
Y561	yellow	ON = INU modulating
Y562	yellow	ON = tripped, depending on the fault class the MCB is opened or remains closed
Y563	yellow	ON = tripped, pulses are removed
Y564	yellow	Always OFF
Y565	yellow	ON = tripped with firing through
Y566	yellow	ON = tripped with firing through
Y567	yellow	ON = tripped with zero vector
Y568	yellow	Always OFF

Table 13-4 LEDs of PUP/PFF INT Board in COU

LED	LED Color	Function
Y561	yellow	ON = all PPCC links to INT 0 are OK
Y562	yellow	ON = all PPCC links to INT 1 are OK
Y563	yellow	ON = all PPCC links to INT 2 are OK
Y564	yellow	ON = INT 4 PFF link OK
Y565	yellow	ON = INT 3 PFF link OK
Y566	yellow	ON = INT 2 PFF link OK
Y567	yellow	ON = ARU or INT 5 PFF link OK
Y568	yellow	ON = INT 1 PFF link OK

13.3 GUSP

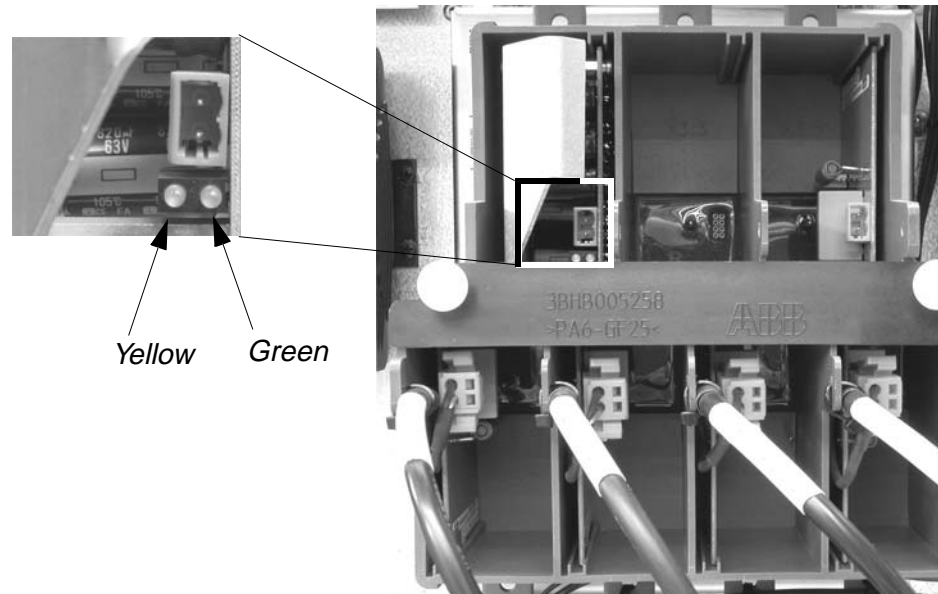

Figure 13-3 GUSP

Table 13-5 LEDs

Yellow LED	Green LED	Function
ON	-	Stabilized voltage (20 VDC) OK
-	ON	Load connected
ON	ON	Stabilized voltage and load OK
FLASHING	FLASHING	Stabilized voltage OK, load has short circuit
OFF	OFF	Gate unit not supplied or supply unit faulty

Table 13-5 is applicable for GUSP units with the following ID numbers:

- 3BHB005243R0105 (GUSP type KU C755AE105)
- 3BHB005243R0106 (GUSP type KU C755AE106)
- 3BHB005243R0107 (GUSP type KU C755AE107)

13.4 IGCT

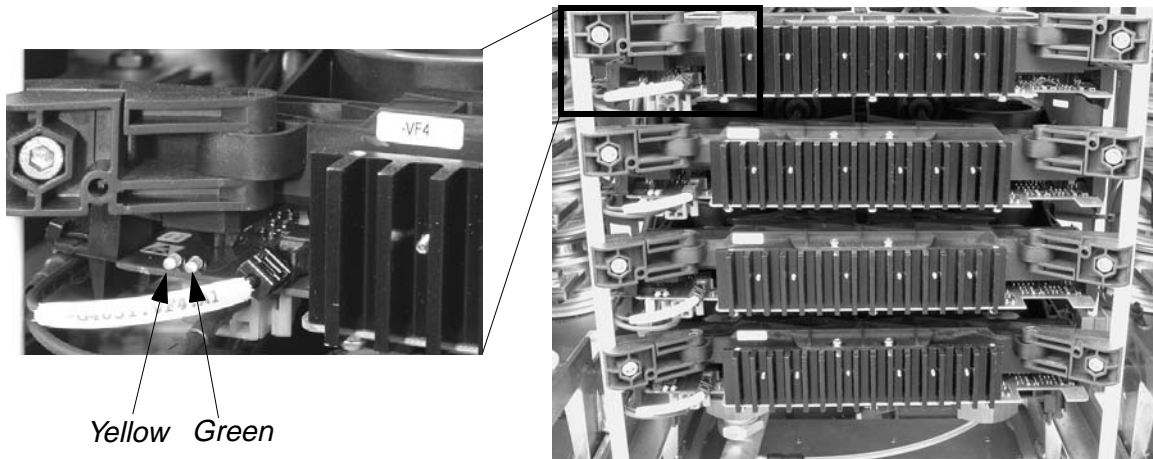

Figure 13-4 IGCT

Table 13-6 LEDs

Yellow LED	Green LED	Function
ON	ON	Output stage functions correctly ($U_{out} > 10\text{ V}$) No overload ($U_{out} < 17\text{ V}$)
FLASHING (if output voltage decreases below 10 V)	FLASHING	Output stage functions correctly Overload present or output shorted: - Output voltage $< 17\text{ V}$ - Regulating board repeatedly attempts to connect
OFF	ON	Yellow LED or its actuation is defective
OFF	OFF	No supply voltage Regulating board defective

Chapter 14 - Tightening Torques and Threaded Connections

14.1 Water Cooling Unit

14.1.1 Tightening Torque for Pipe Coupling (WCU Type 29 and 52)

Table 14-1 Tightening Torques

Part	Thread Diameter	Tightening Torque
Hex. nut	M10	30 - 35 Nm

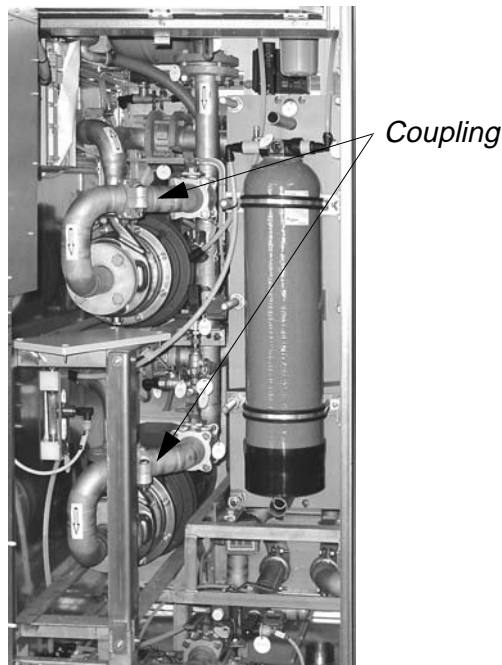

Figure 14-1 Pipe Couplings

14.1.2 Tightening Torque for Pumps (WCU Type 29 and 52)

Table 14-2 Tightening Torques

Part	Part No. ¹⁾	Thread Diameter	Tightening Torque ²⁾
Hex. head bolt	901.1	M10	30 - 35 Nm
Hex. nut	920.1	M10	30 - 35 Nm
Hex. nut	920.4	M12x15	45 - 55 Nm

1) see Figure 14-2 to locate the parts

2) for lubricated threads

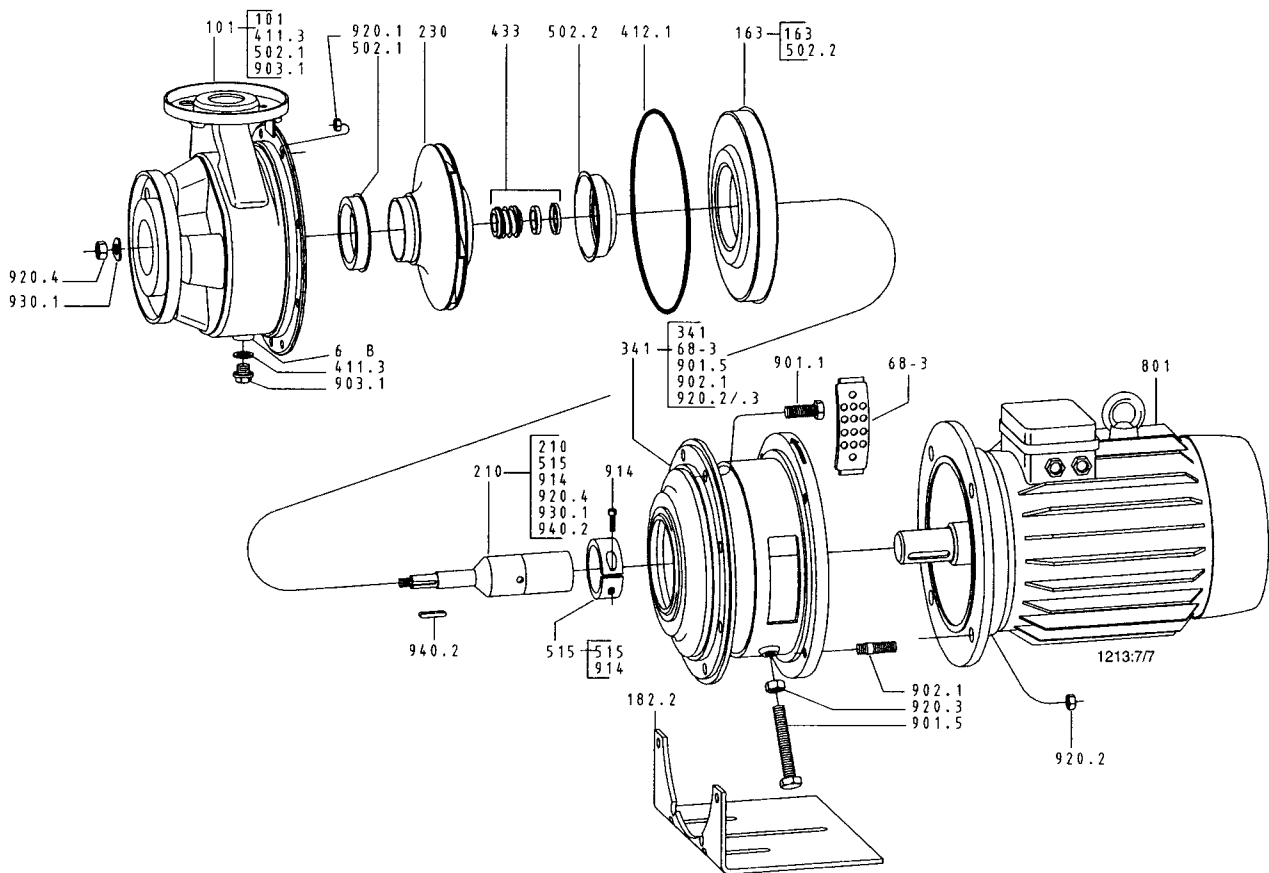

Figure 14-2 Exploded View

Table 14-3 List of Components

Item No.	Description	Item No.	Description
101	Pump casing	68-3	Cover plate
163	Discharge cover	801	Flanged motor
182.2 ²⁾	Pump foot	901.1/5	Hex. head bolt
210	Shaft	902.1	Stud
230	Impeller	903.1	Screwed plug
341	Drive lantern	914	Socket head cap screw
411.3	Joint ring	920.1-.4	Hex. nut
412.1	O-ring	930.1	Spring washer
433	Mechanical seal	940.2	Key
502.1/.2 ¹⁾	Casing wear ring	6B	Casing drain
512	Taper lock ring		

1) not fitted on Etachrom 25-160/..., 32-160/...

2) not fitted

14.1.3 Tightening Torque for Flanges (WCU Types 29, 52, 80, 106, 120)

Table 14-4 Tightening Torques

DN	Hexagon Screw 1	Nut 2	Washer (D x d x t) 3	Gasket (D x d x t) 4	Tightening Torque
25	M12-55	M12	24 x 13 x 2	73 x 40 x 1.5	24 - 33 Nm
32	M16-65	M16	30 x 73 x 3	84 x 48 x 1.5	60 - 80 Nm
40	M16-65	M16	30 x 73 x 3	92 x 57 x 1.5	60 - 80 Nm
50	M16-70	M16	30 x 73 x 3	107 x 66 x 1.5	60 - 80 Nm
65	M16-70	M16	30 x 73 x 3	128 x 23 x 1.5	60 - 80 Nm
80	M16-75	M16	30 x 73 x 3	144 x 97 x 1.5	60 - 80 Nm
100	M16-80	M16	30 x 73 x 3	162 x 125 x 1.5	60 - 80 Nm

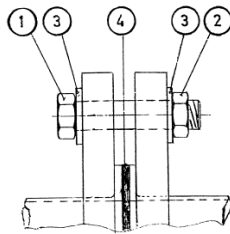

Figure 14-3 Flange Connection

14.2 Pipe Joints and Busbar Connections

Table 14-5 Tightening Torque

Item	Tightening Torque
Pipe joints	7.5 Nm
Bolted busbar connections - DC busbars - AC busbars	30 Nm

