

Allen-Bradley

DeviceNet™ Communications Module

Catalog Number 1203-GK5 or 1336-GM5
Firmware 1.xxx-3.xxx

DeviceNet
CONFORMANCE TESTED™

User Manual

**Rockwell
Automation**

Important User Information

Solid state equipment has operational characteristics differing from those of electromechanical equipment. “*Safety Guidelines for the Application, Installation and Maintenance of Solid State Controls*” (Publication SGI-1.1 available from your local Allen-Bradley Sales Office or online at <http://www.ab.com/manuals/gi>) describes some important differences between solid state equipment and hard-wired electromechanical devices. Because of this difference, and also because of the wide variety of uses for solid state equipment, all persons responsible for applying this equipment must satisfy themselves that each intended application of this equipment is acceptable.

In no event will the Allen-Bradley Company be responsible or liable for indirect or consequential damages resulting from the use or application of this equipment.

The examples and diagrams in this manual are included solely for illustrative purposes. Because of the many variables and requirements associated with any particular installation, the Allen-Bradley Company cannot assume responsibility or liability for actual use based on the examples and diagrams.

No patent liability is assumed by Allen-Bradley Company with respect to use of information, circuits, equipment, or software described in this manual.

Reproduction of the contents of this manual, in whole or in part, without written permission of the Allen-Bradley Company is prohibited.

Throughout this manual we use notes to make you aware of safety considerations.



ATTENTION: Identifies information about practices or circumstances that can lead to personal injury or death, property damage, or economic loss.

Attentions help you:

- identify a hazard
- avoid the hazard
- recognize the consequences

Important: Identifies information that is especially important for successful application and understanding of the product.



Shock Hazard labels may be located on or inside the drive to alert people that dangerous voltage may be present.

Summary of Changes

The information below summarizes the changes made to the manual since the last release. These changes are a result of the 3.xxx firmware upgrade.

DeviceNet Communications Modules with firmware 3.xxx support an internal (Rockwell use only) Object for use with IntelliCENTER™ software. This firmware update is transparent to the user.

Notes

Using this Manual

Preface

Objectives	P-1
Who Should Use this Manual?	P-1
Purpose of this Manual	P-1
Safety Precautions	P-3
Terms and Abbreviations	P-3
Conventions Used in this Manual	P-4
Rockwell Automation Support	P-4

Overview

Chapter 1

Chapter Objectives	1-1
Overview of the 1203-GK5 Module and 1336-GM5 Board	1-1
Features of the 1203-GK5 Module and 1336-GM5 Board	1-2
SCANport Products	1-3
Hardware and Parts Description	1-4
Overview of Setting Up the 1203-GK5 Module or 1336-GM5 Board	1-5
Required Tools and Equipment	1-6

Configuring the 1203-GK5 Module or 1336-GM5 Board

Chapter 2

Chapter Objectives	2-1
Factory-Default Settings	2-1
Locating the DIP Switches	2-1
Configuring the 1203-GK5 Module or 1336-GM5 Board	2-2

Installing the 1203-GK5 Module or 1336-GM5 Board

Chapter 3

Chapter Objectives	3-1
Selecting Cables	3-1
Installing a 1203-GK5 Module	3-3
Removing the 1203-GK5 Communications Module	3-6
Installing a 1336-GM5 Board	3-7
Removing the 1336-GM5 Communications Board	3-10

Configuring a Scanner to Communicate with the 1203-GK5 Module or 1336-GM5 Board

Chapter 4

Chapter Objectives	4-1
About DeviceNet Manager	4-1
About RSNetWorx for DeviceNet	4-1
Required Equipment and Software	4-1
Getting Started	4-2
Using Online Mode in DeviceNet Manager	4-2
Creating an EDS File for the Adapter and Product	4-4
Configuring a PLC Scanner (1771-SDN) to Communicate with a 1203-GK5 Module or 1336-GM5 Board	4-8
Configuring an SLC Scanner (1747-SDN) to Communicate with a 1203-GK5 Module or 1336-GM5 Board	4-13
Saving a Configuration to a File and Quitting DeviceNet Manager	4-18
Viewing and Editing Parameters	4-20

Creating a Ladder Logic Program	Chapter 5	
	Chapter Objectives	5-1
	Required Equipment	5-1
	About RSLogix	5-1
	About Ladder Logic Programs	5-2
	Example Ladder Logic Programs	5-2
Using DeviceNet Explicit Messages	Chapter 6	
	Chapter Objectives	6-1
	Required Equipment	6-1
	Message Translations	6-1
	Messaging for the 1771-SDN Scanner	6-2
	Messaging for the 1747-SDN Scanner	6-4
	Examples	6-6
	Using Messages to Control SCANport Products	6-11
	Writing to Register Objects	6-12
Troubleshooting	Chapter 7	
	Chapter Objectives	7-1
	LEDs on the DeviceNet Adapter	7-1
	DeviceNet Network Status LED	7-2
	SCANport Status LED States	7-3
Specifications	Appendix A	
	Appendix Objectives	A-1
	DeviceNet Conformance Tested	A-1
	1203-GK5 Module Specifications	A-1
	1336-GM5 Board Specifications	A-2
Parameters in the 1203-GK5 Module and 1336-GM5 Board	Appendix B	
	Appendix Objectives	B-1
	Factory Default Settings	B-1
	Parameters	B-2
DeviceNet Objects	Appendix C	
	Appendix Objectives	C-1
	Object Classes	C-1
	Class Code 0x01 — Identity Object	C-2
	Class Code 0x02 — Message Router Object	C-4
	Class Code 0x03 — DeviceNet Object	C-5
	Class Code 0x05 — Connection	C-6
	Class Code 0x07 — Register Object	C-8
	Class Code 0x0F — Parameter Object	C-10
	Class Code 0x10 — Parameter Group Object	C-16
	Class Code 0x67 — PCCC Object	C-18
	Class Code 0x93 — SCANport Pass-Through Parameter Object	C-20
	Class Code 0x97 — SCANport Pass-Through Fault Object	C-21
	Class Code 0x98 — SCANport Pass-Through Warning Object	C-23
	Class Code 0x99 — SCANport Pass-Through Link Object	C-25

Supported PCCC Messages	Appendix D	
	Appendix Objectives	D-1
	PCCC Support	D-1
	Supported PCCC Messages.	D-2
	Related Documentation	D-2
N-File Addresses	Appendix E	
	Appendix Objectives	E-1
	N-File Addresses	E-1
Supported Emulated Block Transfer Commands	Appendix F	
	Appendix Objectives	F-1
	About Emulated Block Transfer.	F-1
	Supported Emulated Block Transfer Commands	F-1
	Emulated Block Transfer Status Word.	F-2
	Parameter Value Read	F-3
	Parameter Value Write	F-4
	Parameter Read Full	F-5
	Product ID Number Read	F-8
	Scattered Parameter Value Read	F-10
	Scattered Parameter Value Write	F-12
	NVS Functions	F-14
	Fault Command Write	F-15
	Fault Queue Entry Read Full.	F-16
Fault Queue Size	F-18	
Trip Fault Queue Number	F-19	

Notes

Using this Manual

Objectives

Read this preface to become familiar with the organization of the manual. In this preface, you will read about the following:

- Who should use this manual.
- The purpose of this manual.
- Terms and abbreviations.
- Conventions used in this manual.
- Rockwell Automation support.

Who Should Use this Manual?

Use this manual if you are responsible for installing, wiring, programming, or troubleshooting control systems that use the DeviceNet™ communications adapter.

This manual is intended for qualified service personnel responsible for setting up and configuring the DeviceNet communications adapter. You must have previous experience with and a basic understanding of electrical terminology, programming procedures, networking, required equipment and software, and safety precautions.

Purpose of this Manual

This manual is a learning and reference guide for the DeviceNet communications adapter. It describes the procedures needed to install, configure, and troubleshoot the 1203-GK5 module and the 1336-GM5 board.

Contents of this Manual

This manual contains the following information:

Chapter	Title	Contents
Preface	<i>Using this Manual</i>	Describes the purpose, background, and scope of this manual. Also provides information on safety precautions and technical support.
1	<i>Overview</i>	Provides an overview of the 1203-GK5 module, 1336-GM5 board, DeviceNet, and SCANport™.
2	<i>Configuring the 1203-GK5 Module or 1336-GM5 Board</i>	Provides procedures for configuring the 1203-GK5 module and 1336-GM5 board using the DIP switches.
3	<i>Installing the 1203-GK5 Module or 1336-GM5 Board</i>	Provides procedures for installing the 1203-GK5 module or 1336-GM5 board.
4	<i>Configuring a Scanner to Communicate with the 1203-GK5 Module or 1336-GM5 Board</i>	Provides procedures for using DeviceNet Manager to configure scanners to communicate with devices connected to the network with a 1203-GK5 module or 1336-GM5 board.
5	<i>Creating a Ladder Logic Program</i>	Provides an example ladder logic program for a PLC® and an example ladder logic program for an SLC®.
6	<i>Using DeviceNet Explicit Messages</i>	Provides information about explicit messaging, including messaging with PLCs, messaging with SLCs, and using messages to control the SCANport product.
7	<i>Troubleshooting</i>	Provides information on how to troubleshoot the 1203-GK5 module or 1336-GM5 board using the LEDs.
A	<i>Specifications</i>	Provides the specifications for the 1203-GK5 module and 1336-GM5 board.
B	<i>Parameters in the 1203-GK5 Module and 1336-GM5 Board</i>	Describes the parameters in the 1203-GK5 module and 1336-GM5 board.
C	<i>DeviceNet Objects</i>	Defines the DeviceNet object classes, class services, and attributes that are supported by the 1203-GK5 module and the 1336-GM5 board.
D	<i>Supported PCCC Messages</i>	Provides a reference list of PCCC messages supported by the 1203-GK5 module and 1336-GM5 board.
E	<i>N-File Addresses</i>	Lists the N-files to which messages can be written.
F	<i>Supported Emulated Block Transfer Commands</i>	Provides a reference list of emulated block transfer commands.

Related Publications

Title	Publication Number
DeviceNet Manager Software User Manual	1787-6.5.3
1771-SDN Scanner Configuration Manual	1771-6.5.118
DeviceNet Scanner Configuration Manual	1747-6.5.2
DeviceNet Cable System Planning and Installation Manual	DN-6.7.2

Safety Precautions

Please read the following safety precautions carefully.



ATTENTION: Only personnel familiar with Allen-Bradley SCANport products and associated machinery should plan or implement the installation, start-up, configuration, and subsequent maintenance of the 1203-GK5 or 1336-GM5 DeviceNet communications adapter. Failure to comply may result in personal injury and/or equipment damage.



ATTENTION: Remove all power from the SCANport product before installing the 1336-GM5 board. Failure to disconnect power may result in death or serious injury. Verify all power is removed before installing the 1336-GM5 board.



ATTENTION: Hazard of equipment damage exists. If explicit messages are programmed to frequently write parameter data to certain drive products, the EEPROM (Non-Volatile Storage) will quickly exceed its life cycle and cause the product to malfunction. Do not create a program that frequently uses explicit messages to write parameter data to a product. Datalinks do not write to the EEPROM and should be used for frequently changed parameters.

Terms and Abbreviations

The following terms and abbreviations are specific to this product. For a complete listing of Rockwell Automation terminology, refer to the *Industrial Automation Glossary*, Publication AG-7.1.

Terms	Definition
DeviceNet	An open network that provides probabilistic I/O control through a managed bit-wise non-destructive multiplexing scheme.
SCANport	A standard peripheral communications interface for various Rockwell Automation drives and power products.
SCANport Peripheral	A device that provides an interface between SCANport and a network. It is often referred to as an adapter. For example, the DeviceNet adapter is a SCANport peripheral.
SCANport Product	A device that uses the SCANport communications interface to communicate with one or more peripheral devices. For example, a motor drive such as a 1336 PLUS is a SCANport product.
DeviceNet Adapter	Both the 1203-GK5 module and the 1336-GM5 board are DeviceNet adapters. In this manual, the term "adapter" is used when both the module and the board are referred to.

Conventions Used in this Manual

The following conventions are used throughout this manual:

- Bulleted lists provide information, not procedural steps.
- Numbered lists provide sequential steps or hierarchical information.
- *Italic* type is used for chapter names, parameter names, and book names.
- **Bold** type is used for names of menus and menu options.

Important: This type of paragraph contains tips or notes that have been added to call attention to useful information.

Rockwell Automation Support

Rockwell Automation offers support services worldwide, with more than 75 sales/support offices, more than 500 authorized distributors, and more than 250 authorized systems integrators located throughout the United States alone. In addition, Rockwell Automation representatives are in every major country in the world.

Local Product Support

Contact your local Rockwell Automation representative for:

- Sales and order support.
- Product technical training.
- Warranty support.
- Support service agreements.

Technical Product Support

If you need to contact Rockwell Automation for technical assistance, please call your local Rockwell Automation representative.

Refer to <http://www.ab.com> for updates and supporting documentation.

Overview

Chapter Objectives

Chapter 1 provides an overview of 1203-GK5 module and 1336-GM5 board. In this chapter, you will read about the following:

- Function of the 1203-GK5 module or 1336-GM5 board.
- Features of the 1203-GK5 module and 1336-GM5 board.
- SCANport products.
- Parts and hardware of the 1203-GK5 module and 1336-GM5 board.
- Steps for setting up the adapter.
- Required tools and equipment.

Overview of the 1203-GK5 Module and 1336-GM5 Board

There are two types of DeviceNet adapters: the 1203-GK5 module and 1336-GM5 board.

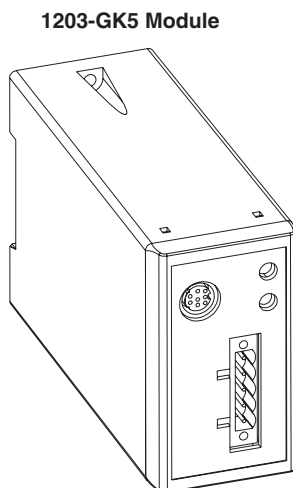
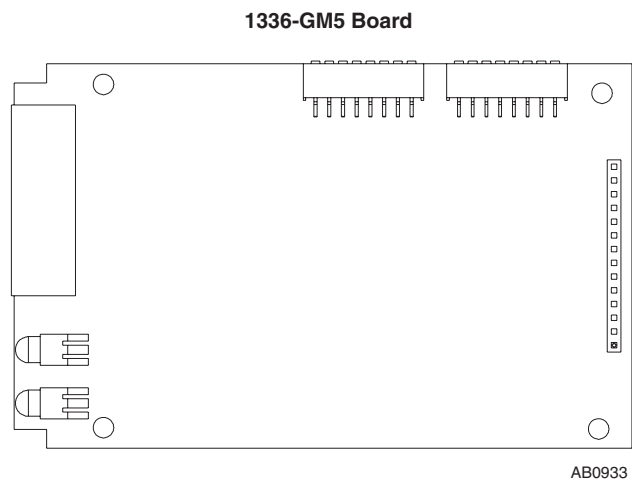

Figure 1.1
1203-GK5 Module and 1336-GM5 Board



The 1203-GK5 module mounts on a DIN rail and connects to the SCANport product via a SCANport cable. The 1336-GM5 board mounts directly onto selected SCANport products and connects to the SCANport product via an internal connector.

Both types of DeviceNet communications adapters provide an electronic communications interface between a DeviceNet network and any single SCANport product.

Figure 1.2
Example DeviceNet Network

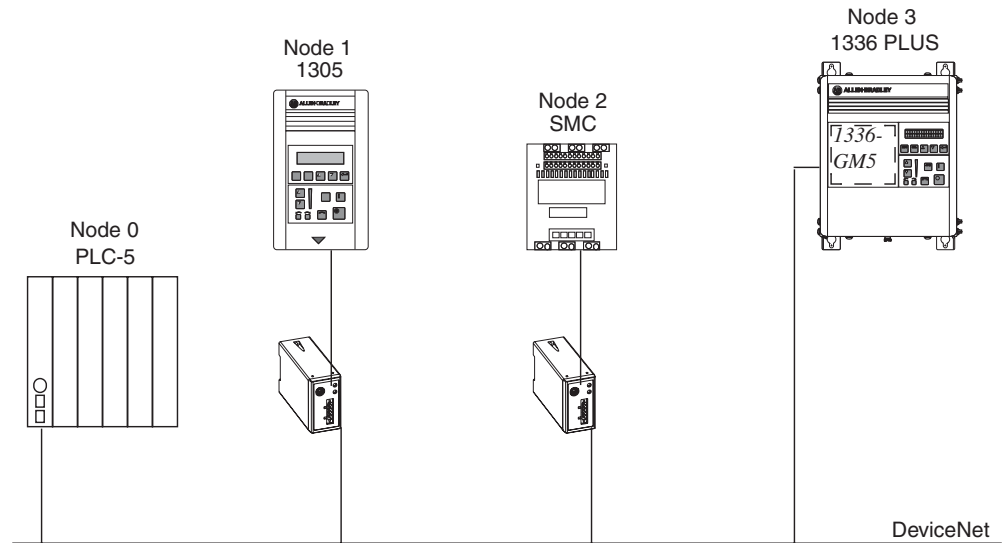

In Figure 1.2, Node 1 and Node 2 use a 1203-GK5 module to connect to the DeviceNet network, and Node 3 uses a 1336-GM5 board to connect to it. SCANport cables connect 1203-GK5 modules to their SCANport products. DeviceNet cables connect the modules and board to the DeviceNet network. The modules and board then convert DeviceNet messages into SCANport messages for the product.

Features of the 1203-GK5 Module and 1336-GM5 Board

The DeviceNet network is an open, global industry-standard communication network designed to provide an interface through a single cable from a programmable controller directly to “smart” devices such as sensors, push buttons, motor starters, and drives.

The 1203-GK5 module and 1336-GM5 board let you connect your SCANport products to a DeviceNet network. They feature the following:

- DIP switches let you configure the module or board before connecting it to the network. (The module or board can also be configured using parameters which software tools such as DeviceNet Manager, RSNetWorx™ for DeviceNet, and DriveExplorer™ can access.)
- Faulted Node Recovery lets you change the node address of a device when it is bus-off on the network. (This feature requires the support of proper software tools, and DIP switches SW 2-7 and SW 2-8 must be set to the On position.)
- User fault response configuration provides the ability to customize the adapter actions to communication errors.
- LEDs help to diagnose network and SCANport product health.
- With simple polling operation, the adapter can pass I/O between a controller and SCANport product.

SCANport Products

Some SCANport products support only one peripheral; others support up to six peripherals. The table below lists many SCANport products, the number of peripherals each supports, the minimum and maximum I/O words, and the type of adapter that can be used.

Product	Number of Peripherals Supported	I/O Words		Adapter Use	
		Minimum	Maximum	1203-GK5	1336-GM5
1305 AC MICRO Drive	5	2	10	Yes	No
1336 IMPACT™ Drive	6 ^①	2	10	Yes	Yes ^②
1336 PLUS AC Drive	6 ^①	2	10	Yes	Yes ^②
1336 PLUS II Drive	6 ^①	2	10	Yes	Yes
1336 FORCE™ Drive	6 ^①	2	10	Yes	Yes ^③
1336 SPIDER Drive	6 ^①	2	10	Yes	Yes
1394 AC Multi-Axis Motion Control System	5	2	10	Yes	No
SMC Dialog Plus	1	2	2	Yes	No
SMP-3 Smart Motor Protector	2	2	2	Yes	No
1397 Digital DC Drive	5	2	10	Yes	No
1557 Medium Voltage Drive	5	2	10	Yes	No

- ① Lower horsepower products may not support a sixth peripheral. Refer to the user manual to verify that your product supports a sixth peripheral.
- ② Lower horsepower products may not support an internal mounted 1336-GM5 board. Refer to the product user manual.
- ③ Drive must be 30 hp or above, and it must use a standard adapter board.

Important: To connect multiple peripherals to a SCANport product, a port expander may be required. Refer to your product documentation for more information.

Important: If you intend to use datalinks to communicate with and control your SCANport product, verify that your SCANport product supports datalinks before enabling them in the adapter. Each datalink can be used by only one adapter at a time, so make sure that a datalink is not being used by another adapter before enabling it.

Hardware and Parts Description

The hardware included with the adapter depends on the adapter that you have.

1203-GK5 Module Hardware

Figure 1.3 illustrates and the following table lists the main parts of the 1203-GK5 DeviceNet communications module:

Figure 1.3
Parts of the 1203-GK5 Module

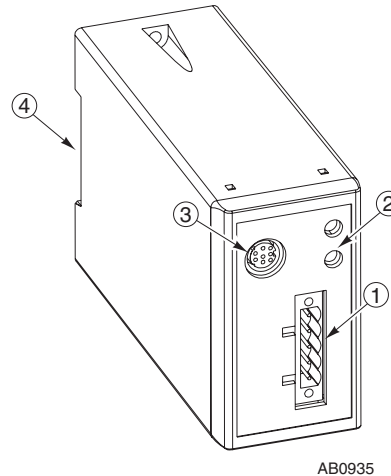

Number	Part	Description
1	DeviceNet Connection	Provides a 5-pin Phoenix connector to attach the module to the network.
2	Bi-Color LEDs	Indicate the status of the DeviceNet media channel and of the SCANport connection. For more information, refer to Chapter 7, <i>Troubleshooting</i> .
3	SCANport Connection	Provides a standard SCANport 8-pin circular mini-DIN connector for the SCANport cable.
4	DIN Rail Mount	Securely attaches and electronically grounds the module to the DIN rail.
Not Shown	DIP Switches	Located on the bottom of the module, these switches are used to configure the module. For more information, refer to Chapter 2, <i>Configuring the 1203-GK5 Module or 1336-GM5 Board</i> .
Not Shown	5-Pin Plug-In Connector	This part is supplied with the module. The 5-pin plug-in connector is a connector to attach to the DeviceNet cable.
Not Shown	10-Pin Plug-In Connector	This part is supplied with the module. The 10-pin plug-in connector is a connector to attach to the DeviceNet cable.

1336-GM5 Board Hardware

Figure 1.4 illustrates and the following table lists the main parts of the 1336-GM5 DeviceNet communications board:

Figure 1.4
Parts of the 1336-GM5 Board

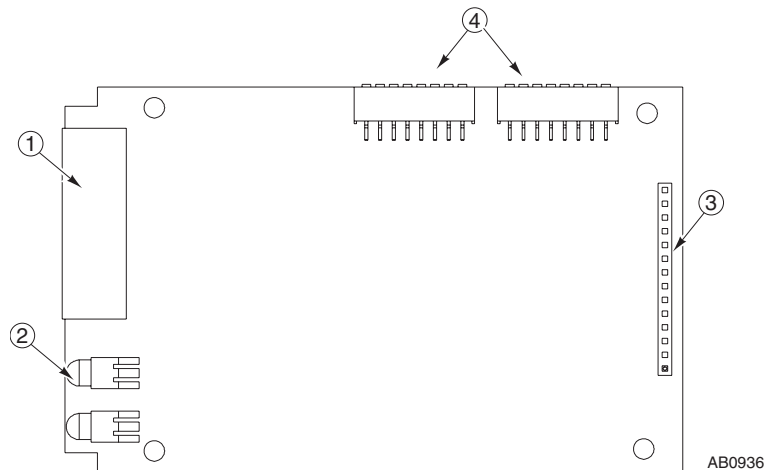

Number	Part	Description
1	DeviceNet Connection	Provides a 5-pin Phoenix connector to attach the module to the DeviceNet network.
2	Bi-Color LEDs	Indicate the status of the DeviceNet media channel and of the SCANport connection. For more information, refer to Chapter 7, <i>Troubleshooting</i> .
3	SCANport Connection	Provides a 14-pin connector containing power and SCANport communication circuitry.
4	DIP Switches	Located on the bottom of the module, these switches are used to configure the module. For more information, refer to Chapter 2, <i>Configuring the 1203-GK5 Module or 1336-GM5 Board</i> .
Not Shown	Kit	Provides the necessary materials for mounting the board to the SCANport product. These materials include one grounding wrist strap, four Phillips mounting screws, four stand-off nylon headers, one 5-pin connector, and one snap-in comm housing with mounting instructions.

Overview of Setting Up the 1203-GK5 Module or 1336-GM5 Board

To set up the 1203-GK5 module or 1336-GM5 board, you must perform the following tasks:

1. Set the node address and configure the parameters. Refer to Chapter 2, *Configuring the 1203-GK5 Module or 1336-GM5 Board*.
2. Install the module or mount the board. Refer to Chapter 3, *Installing the 1203-GK5 Module or 1336-GM5 Board*.
3. Configure a scanner (either PLC or SLC) to communicate with the new node. Refer to Chapter 4, *Configuring a Scanner to Communicate with the 1203-GK5 Module or 1336-GM5 Board*.
4. If necessary, create a ladder logic program to control the SCANport product. Refer to Chapter 5, *Creating a Ladder Logic Program*.

Required Tools and Equipment

The tools and equipment required, depend on if you are using a 1203-GK5 module or 1336-GM5 board.

1203-GK5 Module

When unpacking the 1203-GK5 module, ensure that the contents of the shipping box include:

- 1203-GK5 DeviceNet Communications Module.
- 5-pin and 10-pin plug-in connector.
- DeviceNet Communications Module User Manual.

To install the 1203-GK5 module, ensure that you have the following tools and equipment:

- 35 x 7.5 mm DIN rail A.
- 1/8" flathead screwdriver.
- Appropriate cables for SCANport and DeviceNet connections. Refer to the “Selecting Cables” section in Chapter 3, *Installing the 1203-GK5 Module or 1336-GM5 Board*.
- A computer that is:
 - Running DeviceNet Manager or RSNetWorx for DeviceNet.
 - Connected to and communicating with the DeviceNet network using an available computer to DeviceNet interface such as a 1784-PCD card or a 1770-KFD adapter.
 - Able to connect to a PLC or SLC.
 - Running RSLinx.
 - Running RSLogix5 (if using PLC) or RSLogix500 (if using SLC).

Important: Refer to <http://www.software.rockwell.com> for more information on these software products.

1336-GM5 Board

When unpacking the 1336-GM5 board, ensure that the contents of the shipping box include:

- 1336-GM5 DeviceNet Communications Board.
- One 5-pin plug-in connector.
- One grounding wrist strap.
- Four Phillips mounting screws.
- Four stand-off nylon headers.
- One snap-in communications housing with mounting instructions.
- DeviceNet Communications Module User Manual.

To install and configure a 1336-GM5 board, ensure that you have the following tools and equipment:

- #1 Phillips screwdriver.
- Appropriate cable for the DeviceNet connection. Refer to the “Selecting Cables” section in Chapter 3, *Installing the 1203-GK5 Module or 1336-GM5 Board*.
- A computer that is:
 - Running DeviceNet Manager or RSNetWorx for DeviceNet.
 - Connected to and communicating with the DeviceNet network using an available computer to DeviceNet interface such as a 1784-PCD card or a 1770-KFD adapter.
 - Able to connect to a PLC or SLC.
 - Running RSLinx.
 - Running RSLogix5 (if using PLC) or RSLogix500 (if using SLC).

Important: Refer to <http://www.software.rockwell.com> for more information on these software products.

This Page Intentionally Left Blank.

Configuring the 1203-GK5 Module or 1336-GM5 Board

Chapter Objectives

Chapter 2 provides instructions and information that you need to configure the 1203-GK5 module or 1336-GM5 board. In this chapter, you will read about the following:

- Factory-default settings.
- Configuring the adapter.

Factory-Default Settings

The 1203-GK5 and 1336-GM5 are shipped with these settings:

- 16-bit logic command/status enabled for polling.
- 16-bit reference/feedback enabled for polling.
- If the scanner is put into program mode or the network fails, the SCANport product is faulted by the module.
- A node address of 63.
- DeviceNet data rate of 125K.

Locating the DIP Switches

To configure the 1203-GK5 module or 1336-GM5 board, you must set their DIP switches. On the 1203-GK5 module, DIP switches are found in the following location.

Figure 2.1

Switches on the 1203-GK5 Module

- SW1.1 = Datalink A
- SW1.2 = Datalink B
- SW1.3 = Datalink C
- SW1.4 = Datalink D
- SW1.5 = Not Used
- SW1.6 = Zero Data / Hold Last State
- SW1.7 = Fault on Comm Loss
- SW1.8 = Fault On Pgm / Idle
- SW2.1 – SW2.6 = Node Address Selection
- SW2.7 – SW2.8 = Data Rate Selection

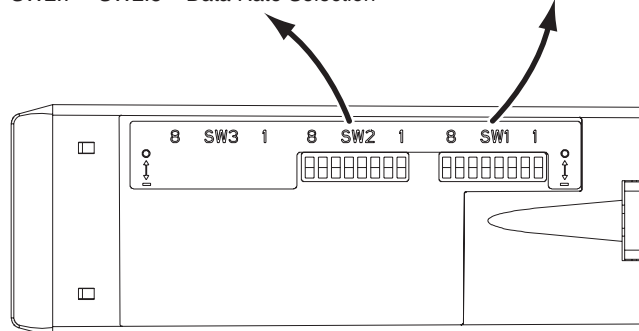

Bottom View

AB0939

On the 1203-GM5 board, DIP switches are found in the following location.

Figure 2.2
Switches on the 1336-GM5 Board

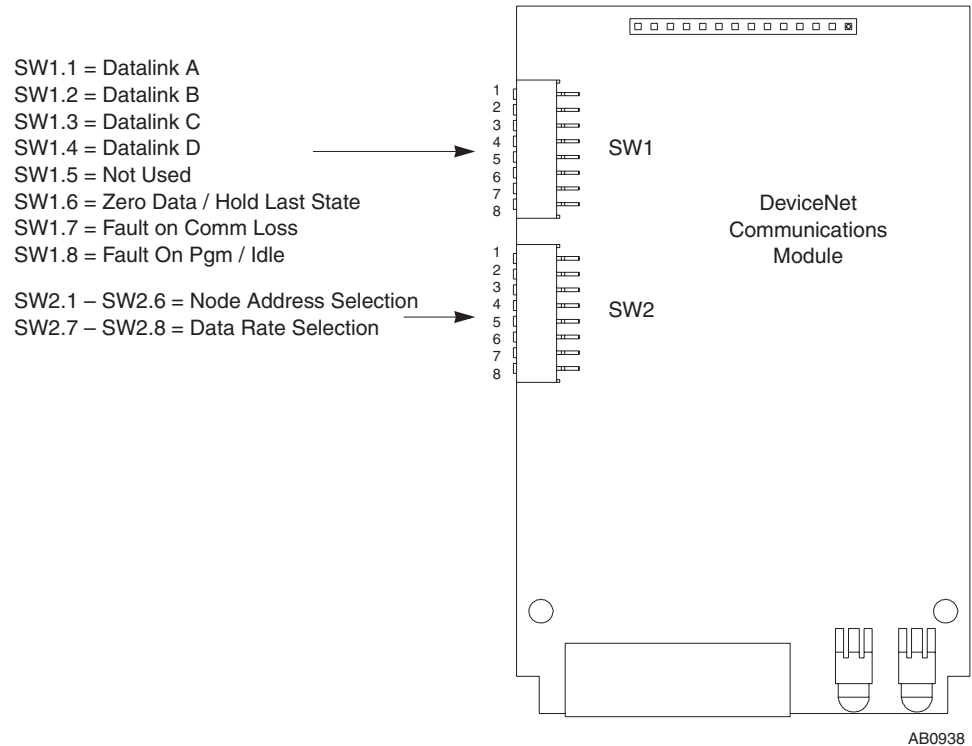

Configuring the 1203-GK5 Module or 1336-GM5 Board

If you do not intend to use the factory-default settings, you must configure the module using its DIP switches. Using the DIP switches, you can configure the following features:

- DeviceNet network data rate.
- Node address for the adapter.
- Datalinks.
- Adapter reaction when the network fails.
- Adapter reaction when the controller is idle (e.g., scanner or controller is in program mode).

Safety Precautions

When configuring the 1203-GK5 module or 1336-GM5 board, please observe the following safety precautions:



ATTENTION: When you make changes to the switch settings, use a blunt, pointed instrument. Do not use a pencil because the lead (graphite) of the pencil may damage the switch assembly.



ATTENTION: Failure to check connections and switch settings for compatibility with your application when configuring the communications module could result in personal injury and/or equipment damage due to unintended or undesirable operation.



ATTENTION: Hazard of injury or equipment damage exist due to unintended or incorrect machine motion. When a system is configured for the first time, the motor must be disconnected from the machine or process during initial system testing.

Setting the Node Address

DIP switches 6 through 1 on SW2 set the node address for the 1203-GK5 module or 1336-GM5 board. The factory-default setting is DeviceNet node address 63.

Figure 2.3
Setting the Node Address

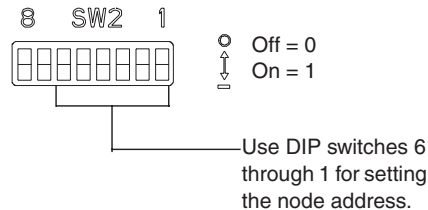

To edit the node address, you need to:

1. Refer to the following table to determine the switch settings:

DeviceNet Address	Switch Setting 6 <---- 1	DeviceNet Address	Switch Setting 6 <---- 1	DeviceNet Address	Switch Setting 6 <---- 1	DeviceNet Address	Switch Setting 6 <---- 1
0	000000	16	010000	32	100000	48	110000
1	000001	17	010001	33	100001	49	110001
2	000010	18	010010	34	100010	50	110010
3	000011	19	010011	35	100011	51	110011
4	000100	20	010100	36	100100	52	110100
5	000101	21	010101	37	100101	53	110101
6	000110	22	010110	38	100110	54	110110
7	000111	23	010111	39	100111	55	110111
8	001000	24	011000	40	101000	56	111000
9	001001	25	011001	41	101001	57	111001
10	001010	26	011010	42	101010	58	111010
11	001011	27	011011	43	101011	59	111011
12	001100	28	011100	44	101100	60	111100
13	001101	29	011101	45	101101	61	111101
14	001110	30	011110	46	101110	62	111110
15	001111	31	011111	47	101111	63	111111

2. Slide switches 6 through 1 to their appropriate positions.

Important: DIP switch and parameter settings take effect when a module or board first receives power. When you change a setting, you must remove and then reapply power for the new setting to take effect.

Setting the Data Rate

DIP switches 7 and 8 on SW2 set the data rate at which the 1203-GK5 module or 1336-GM5 board communicates on the network. The factory-default setting for the data rate is 125K.

Figure 2.4
Setting the Data Rate

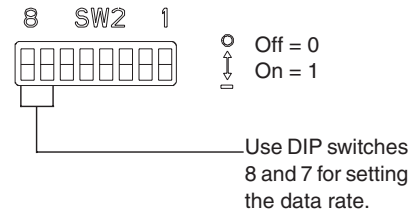

To edit the data rate, you need to:

1. Refer to the following table to determine the switch settings.

Data Rate	Switch 2-8	SW2-7
125K	0	0
250K	0	1
500K	1	0
Module uses Node Address and Data Rate internally programmed. ^{① ②}	1	1

^① When the switches are set to this position, the communications module data rate and node address can be programmed over DeviceNet using the *DN-NV-Node Adx* and *DN-NV-Data Rate* parameters. For instructions on using DeviceNet Manager to edit parameters, refer to “Viewing and Editing Parameters” on page 4-20.

^② To enable the faulted node recovery feature, SW2-8 and SW2-7 must both be set to On.

2. Slide switches 8 and 7 to their appropriate positions.

Important: DIP switch and parameter settings take effect when a module or board first receives power. When you change a setting, you must remove and then reapply power for the new setting to take effect.

Setting the Datalinks

DIP switches 4 through 1 on SW1 are used to enable or disable datalinks. With datalinks, you can increase the size of I/O transmitted to and from a drive. By enabling a datalink, you can continuously change or monitor the value of a parameter without using the DeviceNet explicit messages.

Each datalink consists of two 16-bit words of input and two 16-bit words of output. (Refer to Figure 5.1 for an illustration.) You can enable a maximum of four datalinks in both the module and board. The factory-default setting disables all datalinks.

Figure 2.5
Setting the Datalinks

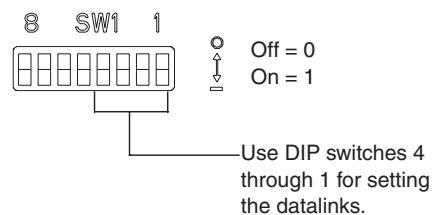

Important: Ensure that datalinks are supported and enabled in the product before you enable them in the 1203-GK5 module or 1336-GM5 board.

To edit the datalinks, you need to:

1. Refer to the following table to determine the switch settings:

Function	Datalink A SW1-1	Datalink B SW1-2	Datalink C SW 1-3	Datalink D SW 1-4
Disable	0	0	0	0
Enable	1	1	1	1

2. Slide switches 1 to 4 to their appropriate positions.

Important: DIP switch and parameter settings take effect when a module or board first receives power. When you change a setting, you must remove and then reapply power for the new setting to take effect.

Setting the Fault Response Configuration Switches

DIP switches 8 through 6 on SW1 let you configure how a 1203-GK5 module or 1336-GM5 board controls a product when network communications fail or the scanner is idle. With the factory-default setting, the product is faulted when communications are disrupted.

Figure 2.6
Setting the Fault Configuration

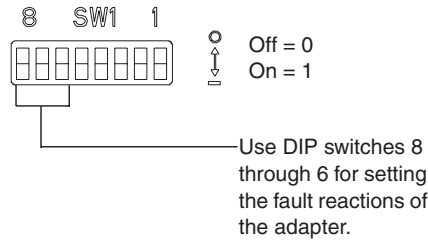

ATTENTION: Risk of severe bodily injury or equipment damage exists. These switches allow the user to change the default configuration that would fault the drive if communication is lost. Precautions should be taken to ensure that settings for these switches do not create a hazard of bodily injury or equipment damage.

To edit how the 1203-GK5 or 1336-GM5 responds when network communications are disrupted, you need to:

1. Refer to the following table to determine the switch settings for SW 1-8:

Fault on Program/Idle	SW1-8
Enable	0
Disable	1

2. Refer to the following table to determine the switch settings for SW 1-7:

Fault on Communications Loss	SW1-7
Enable	0
Disable	1

3. If you set SW 1-8 or SW 1-7 to 1, select how the module or board responds when a condition that normally causes a fault occurs:

Function	SW1-6
Zero data	0
Hold last state	1

4. Slide switches 6 to 8 to their appropriate positions.

Important: DIP switch and parameter settings take effect when a module or board first receives power. When you change a setting, you must remove and then reapply power for the new setting to take effect.

Installing the 1203-GK5 Module or 1336-GM5 Board

Chapter Objectives

Chapter 3 provides the information that you need to install the 1203-GK5 module or 1336-GM5 board. In this chapter, you will read about the following:

- Selecting cables for the SCANport and DeviceNet connections.
- Installing and removing either the 1203-GK5 module or the 1336-GM5 board.

Read “Selecting Cables” on page 3-1. Then, refer to either “Installing a 1203-GK5 Module” on page 3-3 or “Installing a 1336-GM5 Board” on page 3-7.

Selecting Cables

Refer to the following table to determine the cables that you need:

If installing:	Required Cables
1203-GK5 module	SCANport and DeviceNet
1336-GM5 board	DeviceNet

Use the following information to select appropriate cables for each required connection.

SCANport Cables

When selecting the SCANport cable to connect the 1203-GK5 module to the SCANport product, you need to:

- Use an Allen-Bradley SCANport cable. Refer to the table below.

Male to Male Connection		Male to Female Connection	
Length	Catalog Number	Length	Catalog Number
1/3 m	1202-C03	1/3 m	1202-H03
1 m	1202-C10	1 m	1202-H10
3 m	1202-C30	3 m	1202-H30
9 m	1202-C90	9 m	1202-H90

- Use less than 10 meters (33 feet) of cable between the SCANport product and adapter.
- Keep SCANport cables away from high power cables to guard against introducing noise into your system.

DeviceNet Cables

You can connect a device to a DeviceNet network using either a drop line or daisy chain. A drop line connects a device directly to the DeviceNet trunk. In Figure 3.1, Node 1 uses a drop line. A daisy chain connects one device to another device. In Figure 3.1, Node 3 is connected to the network using a daisy chain.

Figure 3.1

Example of 1203-GK5 Modules Connecting SCANport Products to DeviceNet

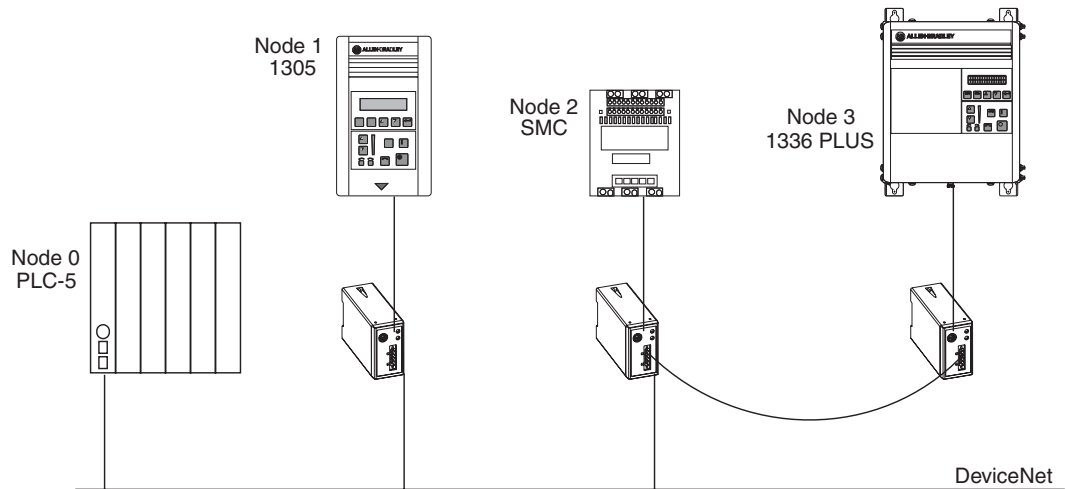

Determine how you are connecting the device to the network, and then refer to the following guidelines:

- Select either a 5-pin connector or a 10-pin connector for the cable. (Both are included with the 1203-GK5 module).
 - Use the 5-pin connector if you are connecting a device to the network using a drop line.
 - Use the 10-pin connector if you are connecting a device using a daisy chaining.
- Determine limitations of the trunk and drop cables. Refer to the following table.

Data Rates	125 Kbps	250 Kbps	500 Kbps
Thick Trunk Line	500 m (1,640 ft)	250 m (820 ft)	100 m (328 ft)
Thin Trunk Lengths	100 m (328 ft)	100 m (328 ft)	100 m (328 ft)
Maximum Drop Length	6 m (20 ft)	6 m (20 ft)	6 m (20 ft)
Cumulative Drop Budget	156 m (512 ft)	78 m (256 ft)	39 m (128 ft)

- Keep DeviceNet cables away from high power cables to guard against introducing noise into your system.

For more information on DeviceNet cables and cable systems, refer to the *DeviceNet Cable System Planning and Installation Manual*, Publication DN-6.7.2.

Installing a 1203-GK5 Module

After selecting the cables that you need, read this section for information and instructions on installing a 1203-GK5 module.

Required Tools and Equipment

To install your 1203-GK5 module, you need the following tools and equipment:

- DeviceNet communications module (1203-GK5).
- Either a 5-pin or 10-pin plug-in connector (supplied with module).
- 35 x 7.5 mm DIN rail A (part 199-DR1; 46277-3; EN 50022).
- 1/8" flathead screwdriver.
- Appropriate cables for SCANport and DeviceNet connections. Refer to the “Selecting Cables” on page 3-1.

Installing the 1203-GK5 Communications Module

The following instructions explain how to physically install your DeviceNet 1203-GK5 communications module.

1. Remove power from the network.
2. Hook the top lip of the module DIN rail mount onto the top of the DIN rail and then rotate the module onto the DIN rail. You will hear the module snap into a locked position.

Figure 3.2
Mounting the Module onto the DIN Rail

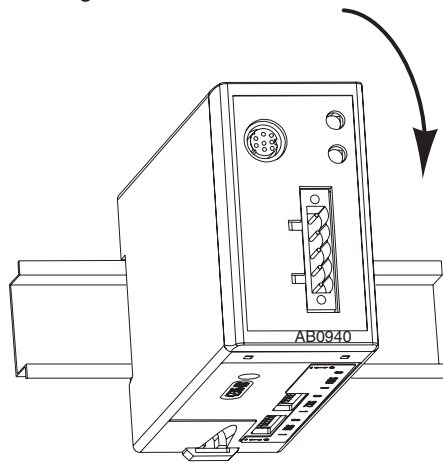

3. Insert the DeviceNet cable wires into the 5-pin or 10-pin connector.



ATTENTION: If you wire the 5-pin or 10-pin header after you have connected it to the module, static control precautions are required. Device malfunction may occur if you do not follow ESD control procedures. If you are not familiar with static control procedures, refer to Rockwell Automation Publication 8000-4.5.2, *Guarding Against Electrostatic Damage*, or other applicable ESD protection handbook.

Figure 3.3
Inserting DeviceNet Cable Wires into a 10-Pin Connector

The Communication Module receives power and communications through the DeviceNet connector. DeviceNet cable wires connect to the DeviceNet plug terminal block as shown in the following table.

Color	Terminal	Signal	Function
Black	1	COM	Common
Blue	2	CAN_L	Signal Low
Bare	3	SHIELD	Shield
White	4	CAN_H	Signal High
Red	5	PWR	Power Supply

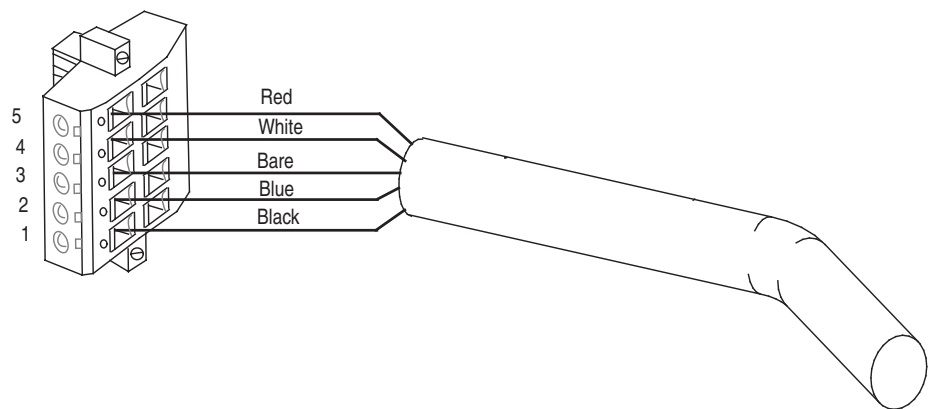

4. Plug the DeviceNet cable into the module. Make sure that you use the color key next to the connector receptacle on the module.

Figure 3.4
Inserting a 5-pin or 10-pin Phoenix Connector

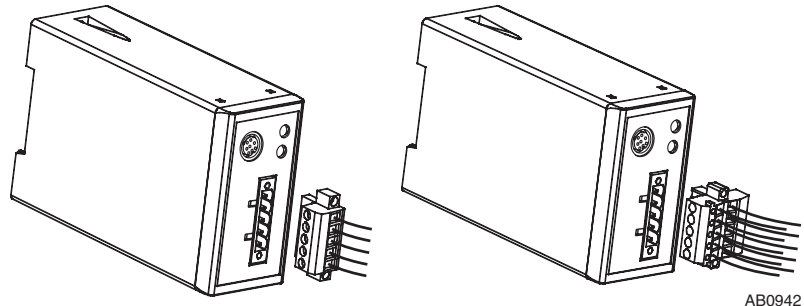

5. Screw the two screws into place using a 1/8" flathead screwdriver.
6. Connect the SCANport cable to the communications adapter and then to the SCANport product.

Figure 3.5
Inserting the SCANport Cable

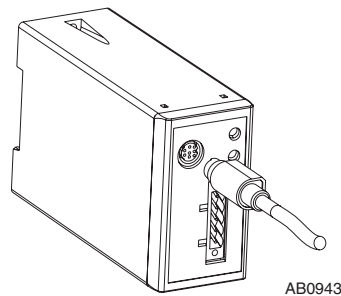

7. Reapply power to the network.
8. If necessary, apply power to the connected SCANport product.

Your 1203-GK5 module is now installed. The SCANport LED is solid green. The network LED is blinking green. You are now ready to configure the scanner to communicate with the module. Refer to Chapter 4, *Configuring a Scanner to Communicate with the 1203-GK5 Module or 1336-GM5 Board*.

Important: If your LEDs are different, refer to Chapter 7, *Troubleshooting*, for more information.

Removing the 1203-GK5 Communications Module

To remove the 1203-GK5 communications module, you need to:

1. Remove power from the network.
2. Remove the SCANport cable from the product and then from the module.
3. Unscrew (using a 1/8" flathead screwdriver) and then unplug the 5-pin or 10-pin connector from the module.
4. Insert a flathead screwdriver into the module DIN rail tab release and gently push the handle toward the module to release the connection tab. Then pull the module up and off the DIN rail.

Figure 3.6
Mounting the Module onto the DIN Rail

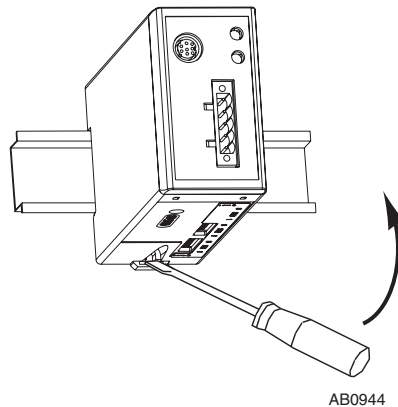

AB0944

Installing a 1336-GM5 Board

After selecting the cables that you need, read this section for information and instructions on installing

Required Tools and Equipment

To install your 1336-GM5 board, you need the following tools and equipment:

- DeviceNet communications board (1336-GM5).
- A kit that includes one grounding wrist strap, four Phillips mounting screws, four stand-off nylon headers, one 5-pin connector and one snap-in comm housing with mounting instructions (supplied with board).
- #1 Phillips screwdriver.
- Appropriate cable for the DeviceNet connection. Refer to the “Selecting Cables” on page 3-1

Electrostatic Discharge Precautions

Please read the following safety precaution carefully before installing the 1336-GM5 communications board.



ATTENTION: The 1336-GM5 communications board contains ESD (Electrostatic Discharge) sensitive parts. Static control precautions are required when installing, testing, or servicing this board. Device malfunction may occur if you do not follow ESD control procedures. If you are not familiar with static control procedures, refer to Rockwell Automation Publication 8000-4.5.2, *Guarding Against Electrostatic Damage*, or other applicable ESD protection handbook.

Installing the 1336-GM5 Communications Board

The following instructions explain how to physically install a DeviceNet 1336-GM5 communications board.

Important: If you are attaching the communications board to a 1336 PLUS II, refer to the one-page insert included with the kit for mounting instructions.

Important: To prevent damage to the board, you must wear a grounding wrist strap when handling the 1336-GM5 communications board.



ATTENTION: Remove all power from the SCANport product before installing the 1336-GM5 board. Failure to disconnect power may result in death or serious injury. Verify all power is removed before installing the 1336-GM5 board.

1. Remove power from the product, and verify that the drive is not holding power.
2. Remove power from the DeviceNet network.
3. Screw the four stand-off nylon headers into the appropriate spaces on the drive main control board.

Figure 3.7
Mounting the Open Style Communications Board

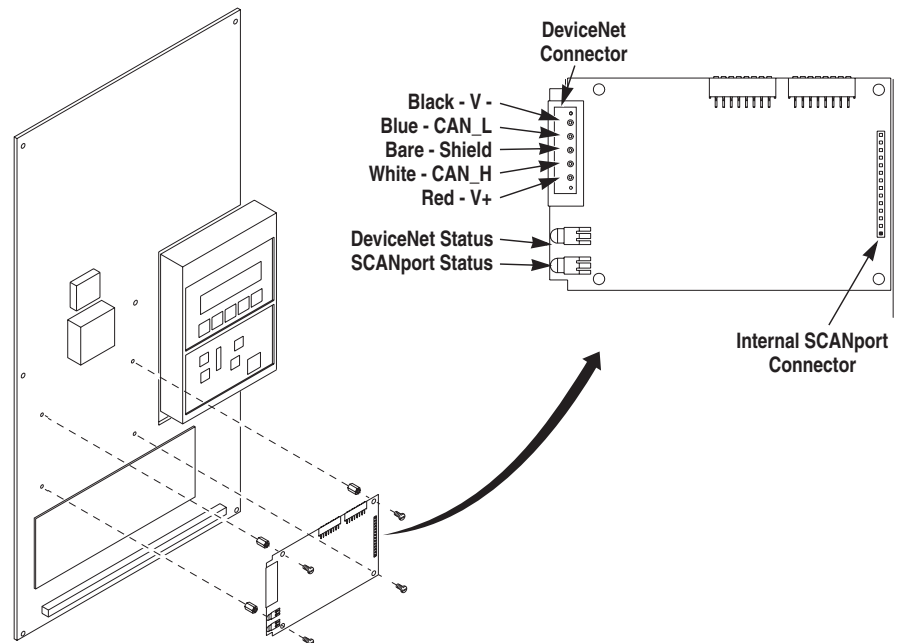

4. Insert the pins located on the 1336-GM5 into the 14-pin SCANport header on the drive. The board should sit squarely on the stand-offs.
5. Using a #1 Phillips screwdriver and the four supplied mounting screws, screw the board securely into place, being careful not to overtighten.
6. Attach the DeviceNet cable wires to the supplied DeviceNet connector. Refer to Figure 3.3 to verify that you have wired the connector correctly.



ATTENTION: Static control precautions are required if you wire the connector when it is already connected to the adapter. It is not recommended that you do this. Device malfunction may occur if you do not follow ESD control procedures. If you are not familiar with static control procedures, refer to Rockwell Automation Publication 8000-4.5.2, *Guarding Against Electrostatic Damage*, or other applicable ESD protection handbooks.

7. Plug the DeviceNet cable into the DeviceNet connector on the board.
8. Screw the two screws into place using a 1/8" flathead screwdriver.
9. Reapply power to the SCANport product.
10. Reapply power to the DeviceNet network.

Your 1203-GM5 board is now installed. The SCANport LED is solid green. The network LED is blinking green. You are now ready to configure the scanner to communicate with the module. Refer to Chapter 4, *Configuring a Scanner to Communicate with the 1203-GK5 Module or 1336-GM5 Board*.

Important: If your LEDs are different, refer to Chapter 7, *Troubleshooting*, for more information.

Removing the 1336-GM5 Communications Board

To remove the 1336-GM5 communications board, you need to:

Important: To prevent damage to the board, you must wear a grounding wrist strap when handling the 1336-GM5 communications board.

Important: If you are removing the communications board from a 1336 PLUS II, refer to the one-page insert included with the kit for special mounting instructions.



ATTENTION: Remove all power from the SCANport product before removing the 1336-GM5 board. Failure to disconnect power may result in death or serious injury. Verify all power is removed before installing the 1336-GM5 board.

1. Remove power from the drive, and verify that the drive is not holding power.
2. Remove power from the DeviceNet network.
3. Unscrew (using a 1/8" flathead screwdriver) and then unplug the DeviceNet connector from the board.
4. With a #1 Phillips screwdriver, unscrew and remove the four mounting screws on the board.
5. Making sure not to bend the pins as they slide out of the 14-pin SCANport connector, gently pull the communications board away from the main control board.
6. Unscrew and remove the four stand-offs from the main control board.

Configuring a Scanner to Communicate with the 1203-GK5 Module or 1336-GM5 Board

Chapter Objectives

Chapter 4 provides instructions for configuring your scanner to communicate with a product connected to either the 1203-GK5 module or 1336-GM5 board. This procedure makes the product an active node on the DeviceNet network. In this chapter, you will read about the following:

- DeviceNet Manager software.
- Equipment and software needed for the configuration.
- Configuring either a PLC or SLC scanner to communicate with the adapter.

This chapter assumes you have experience using DeviceNet Manager to configure a DeviceNet network.

About DeviceNet Manager

DeviceNet Manager is a Windows application that lets you configure DeviceNet networks. While viewing a graphical representation of the network, you can manage, configure, and commission devices on the DeviceNet network.

After installing and configuring the 1203-GK5 module or 1336-GM5 board, you can use DeviceNet Manager to configure the scanner to recognize and communicate with it.

For more information on DeviceNet Manager, refer to the DeviceNet Manager online help, or refer to <http://www.software.rockwell.com>, and search for DeviceNet Manager.

About RSNetWorx for DeviceNet

RSNetWorx for DeviceNet is a Windows application that lets you configure DeviceNet networks. While viewing a graphical representation of the network, you can manage, configure, and commission devices on the DeviceNet network.

This manual presents instructions for using DeviceNet Manager. If you are using RSNetWorx for DeviceNet, refer to its documentation.

Required Equipment and Software

Before configuring the scanner, your computer must be:

- Running DeviceNet Manager.
- Connected to and communicating with the DeviceNet network using a 1784-PCD card or a 1770-KFD adapter.

Getting Started

For the scanner on the DeviceNet network to transmit control I/O and/or messages to the product connected to the 1203-GK5 module or 1336-GM5 board, you must first configure the scanner to recognize and communicate with the product.

The following instructions describe how to use DeviceNet Manager to configure a new DeviceNet network in online mode. The main steps in the configuration are:

- Using online mode in DeviceNet Manager.
- Creating an EDS file for your SCANport product (if necessary).
- Configuring the PLC scanner or SLC scanner.
- Saving the configuration and quitting DeviceNet Manager.

Using Online Mode in DeviceNet Manager

Although you can configure the DeviceNet network offline, it is easier to configure the network online because the software can detect devices connected to the network. The following instructions explain how to go online in DeviceNet Manager.

1. Start DeviceNet Manager.
2. Select **Utilities > Set Up Online Connection** to display the DeviceNet Driver Selection dialog box.

Figure 4.1
DeviceNet Driver Selection Dialog Box

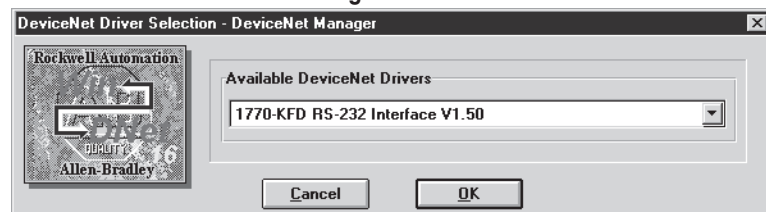

3. Under Available DeviceNet Drivers, select a DeviceNet driver, and click **OK** to display the Driver Configuration dialog box.

Figure 4.2
Driver Configuration Dialog Box

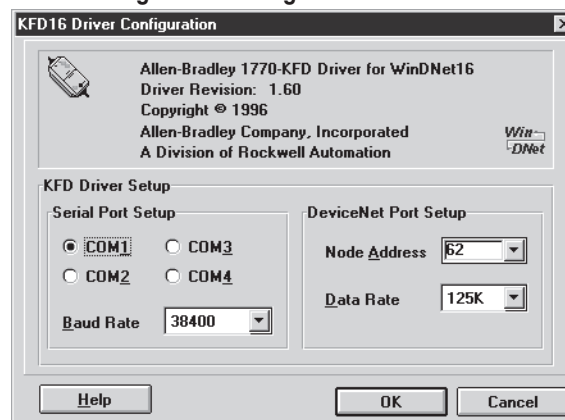

4. Select the appropriate settings for the following:

Box	Description
Port Setting	Select the communications port that your computer is using to connect to the DeviceNet network.
Baud Rate	Select the baud rate that your computer uses to communicate to the DeviceNet network.
Node Address	Type a unique node address for the computer on the DeviceNet network. Do not use 63 because this is the factory-default setting for new devices on the network.
Data Rate	Select the data rate of the DeviceNet network to which you are connecting.

5. Click **OK** to go online.

Figure 4.3
DeviceNet Manager Screen in Online Mode

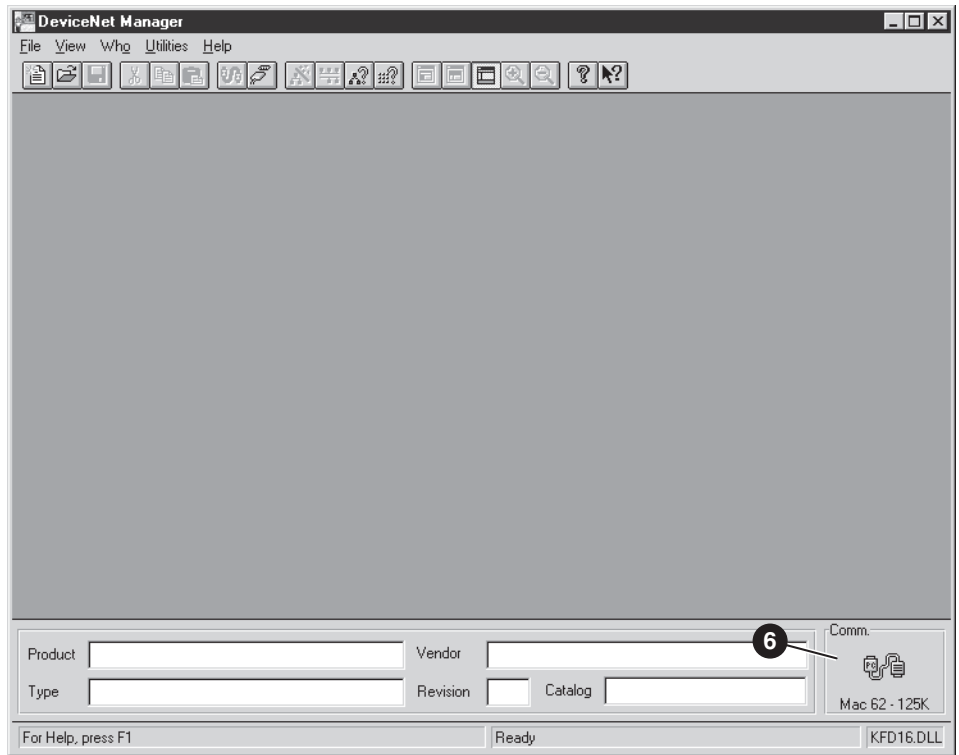

6. Verify that the DeviceNet Manager screen displays the online icon under Comm in the lower right corner of the screen.

You are now in online mode. You must determine if you need an EDS file for the device you are adding. Refer to “Creating an EDS File for the Adapter and Product” on page 4-4.

Creating an EDS File for the Adapter and Product

EDS (Electronic Data Sheet) files are specially formatted ASCII files that provide all of the information necessary for a configuration tool such as DeviceNet Manager to access and alter the parameters of a device. Information about each parameter (e.g., parameter minimum, maximum, and default values) is contained in this file.

Before you can work with a product, you must upload its EDS file. Fortunately, DeviceNet Manager can upload an EDS file from any product over the DeviceNet network.

To upload an EDS file, you need to:

1. Select **Who > Network Who** to display the Network Who screen. DeviceNet Manager immediately scans for devices on the network.

Important: To stop the scan, click **Stop**. You can click **Stop** at any time.

Figure 4.4
Network Who Screen

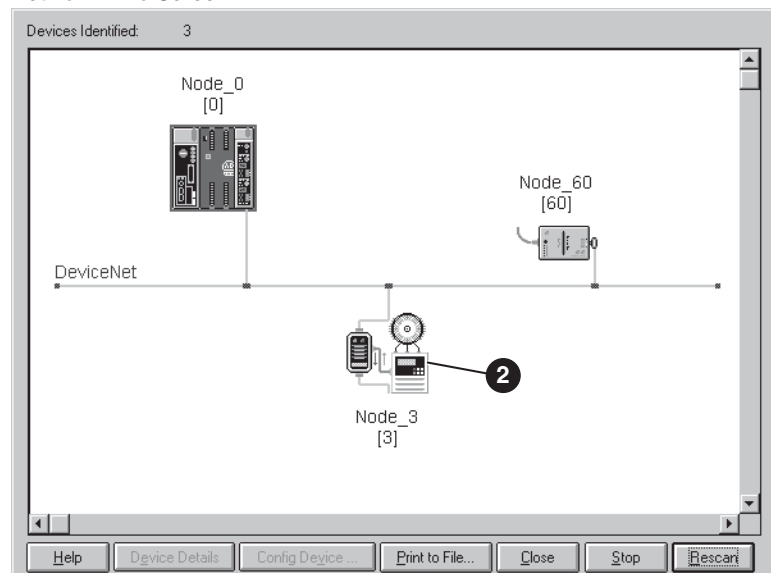

In Figure 4.4, node 0 is the controller. Node 60 is the computer running DeviceNet Manager. Node 3 is the product connected to the network with the 1203-GK5 module or 1336-GM5 board. Node 3 displays a generic icon because DeviceNet Manager does not have an .eds file for it.

2. Double-click the generic product icon. A DeviceNet message asking you to create an EDS file appears.

Important: If the Device Configuration dialog box (Figure 4.39) appears, you do not need to create an .eds file. Refer to the end of this section to determine your next task.

- Click **Yes** to display the Create EDS Stub dialog box.

Figure 4.5
Create EDS Stub Dialog Box

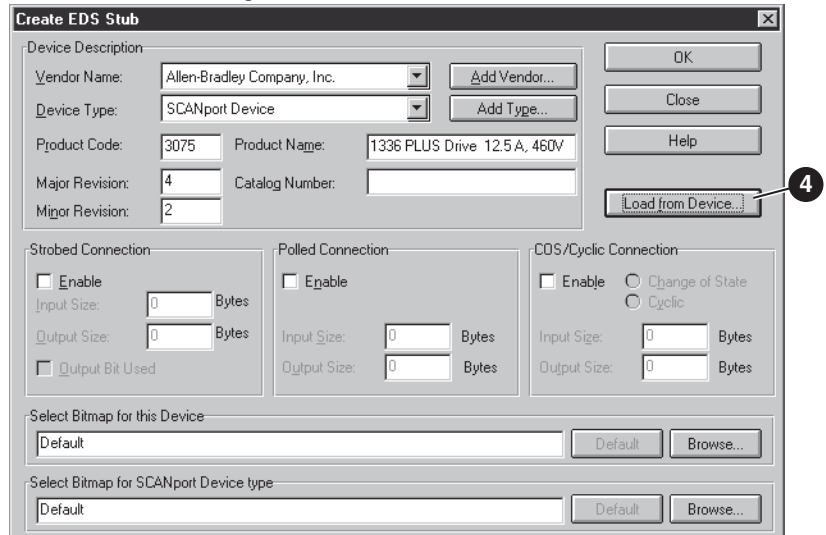

- Click **Load from Device** to display the Load Description from Device dialog box.

Figure 4.6
Load Description from Device Dialog Box

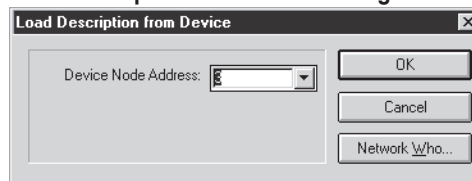

- In the Device Node Address box, type the node address that you set in the 1203-GK5 module or 1336-GM5 board, and then click **OK**. The Loading Device Description dialog box appears and displays the loading status.

Figure 4.7
Loading Device Description Dialog Box

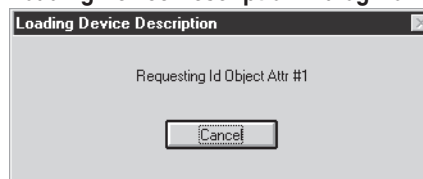

When the device description has completed loading, the Create EDS Stub dialog box reappears.

Figure 4.8
Create EDS Stub Dialog Box

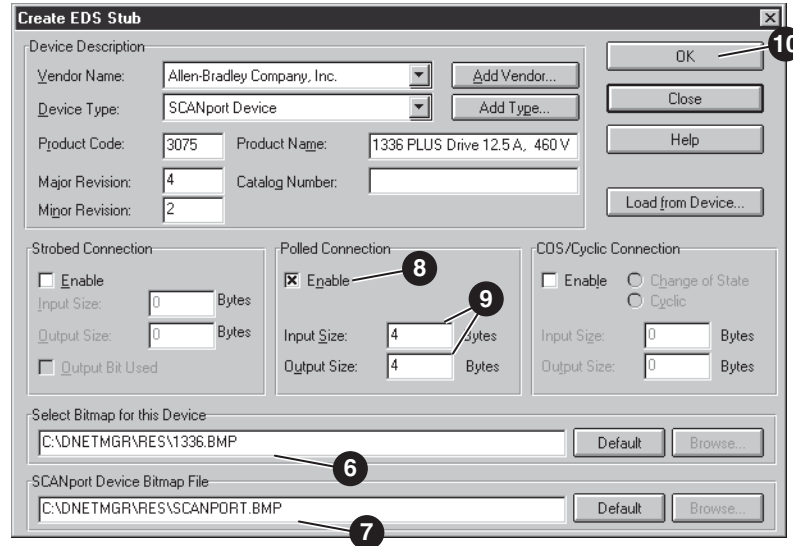

6. In the Select Bitmap for this Device box, select an icon for your product. In our example, we selected 1336.BMP because the product that we are using is a 1336 PLUS drive.

Important: Click **Browse** to go to the C:\DNETMGR\RES directory, where DeviceNet Manager loads icons during the installation.

7. In the SCANport Device Bitmap File box, select the SCANPORT.BMP as an icon for the 1203-GK5 module or 1336-GM5 board. This becomes the default icon for future 1203-GK5 modules and 1336-GM5 boards.

Important: Click **Browse** to go to the C:\DNETMGR\RES directory, where DeviceNet Manager loads icons during the installation.

8. Under Polled Connection, select **Enable**. An “X” appears.
9. Type **4** in the Input Size and Output Size boxes. Four bytes is the default I/O size for products using a 1203-GK5 module or 1336-GM5 board.

10. Click **OK**. A DeviceNet Manager message appears.

Figure 4.9
DeviceNet Manager Message

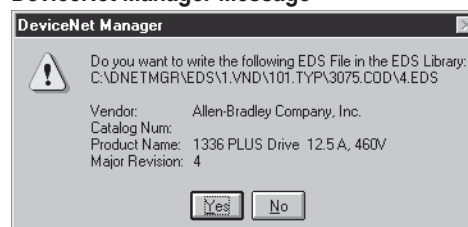

- Click **Yes** to display the EDS File Description dialog box.

Figure 4.10
EDS File Description Dialog Box

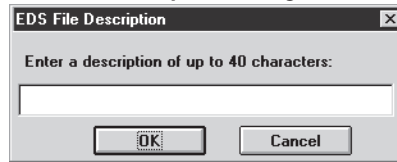

- Enter a description (optional), and then click **OK**. The Network Who screen reappears.
- Click **Rescan**. The screen displays the correct icon for your device. (In our example, it is Node 3.)

Figure 4.11
Network Who Screen

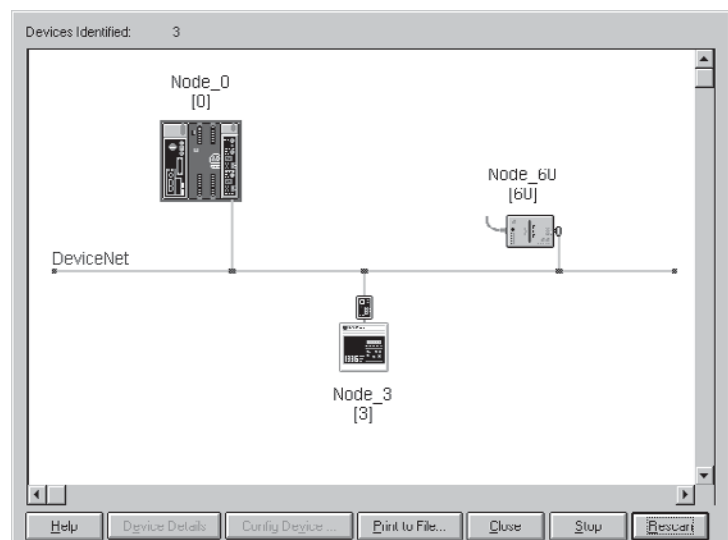

- Click **Close** to close the Network Who screen.

Your device now has an EDS file for DeviceNet Manager to use. You can perform one of the following tasks:

Task	Refer To:
Configure a PLC Scanner (1771-SDN)	"Configuring a PLC Scanner (1771-SDN) to Communicate with a 1203-GK5 Module or 1336-GM5 Board" on page 4-8.
Configure an SLC Scanner (1747-SDN)	"Configuring an SLC Scanner (1747-SDN) to Communicate with a 1203-GK5 Module or 1336-GM5 Board" on page 4-13.
Monitor or edit parameters	"Viewing and Editing Parameters" on page 4-20.

Configuring a PLC Scanner (1771-SDN) to Communicate with a 1203-GK5 Module or 1336-GM5 Board

The following instructions describe how to configure a PLC scanner on a DeviceNet network.

Important: If you are using an SLC scanner (1747-SDN), refer to “Configuring an SLC Scanner (1747-SDN) to Communicate with a 1203-GK5 Module or 1336-GM5 Board” on page 4-13.

For the scanner to communicate with a product connected to the network with a 1203-GK5 module or 1336-GM5 board, the scanner must be properly configured and the product node number must be added to its scan list.

Important: In case you need to revert to the current mapping, you may want to retrieve and save existing mappings in the scanner to a file before adding the module to the scanner mapping.

To configure the PLC scanner to communicate with a 1203-GK5 module or 1336-GM5 board, follow these instructions:

1. Select **Who > Network Who** to display the Network Who screen. DeviceNet Manager immediately scans for devices on the network.

Important: To stop the scan, click **Stop**. You can click **Stop** at any time.

2. Double-click the scanner icon to display the 1771-SDN Module and Channel Configuration dialog box.

Figure 4.12
Module and Channel Configuration Dialog Box

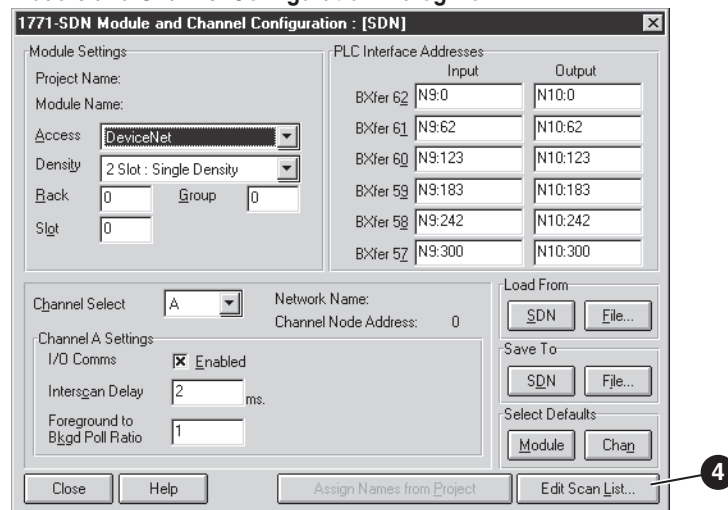

3. Verify the default values. Edit as necessary. Refer to the DeviceNet Manager online help for more information.

- Click **Edit Scan List** to display the 1771-SDN Scan List Editor: Both Channels dialog box.

Figure 4.13

1771-SDN Scan List Editor: Both Channels Configuration Dialog Box



- Under Add Devices From, click **Who** to display the Add Devices to SCAN List dialog box.

Figure 4.14

Network WHO Dialog Box

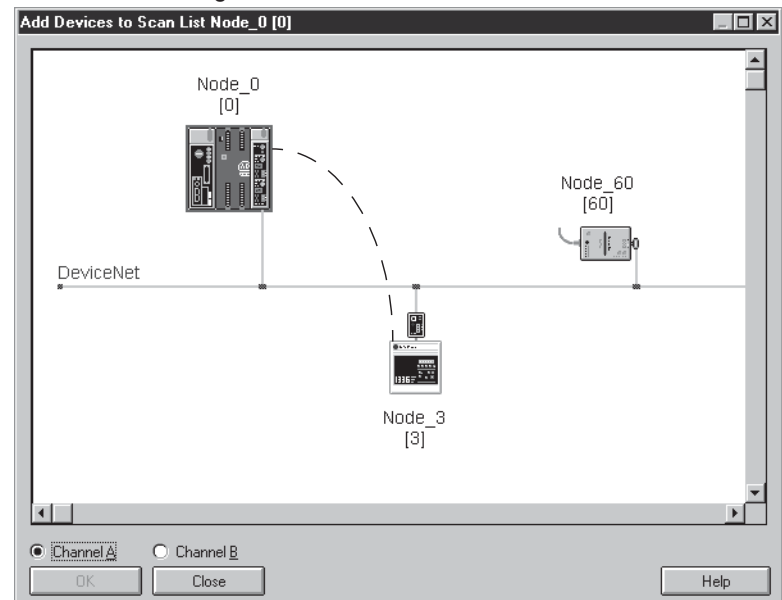

- Drag and drop the node that you want to add onto the scanner icon. The node that you are adding is outlined in red.

- Click **OK** to display the 1771-SDN Scan List Editor: Both Channels dialog box. The new node appears in it.

Figure 4.15

1771-SDN Scan List Editor: Both Channels Dialog Box

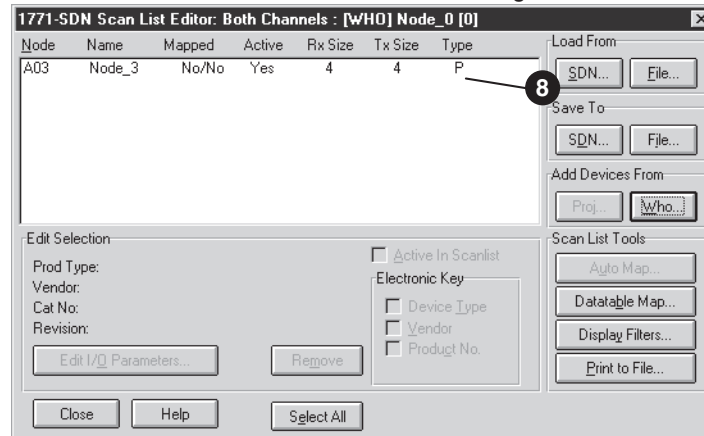

- Click the row of the new node to highlight it.

Figure 4.16

1771-SDN Scan List Editor: Both Channels

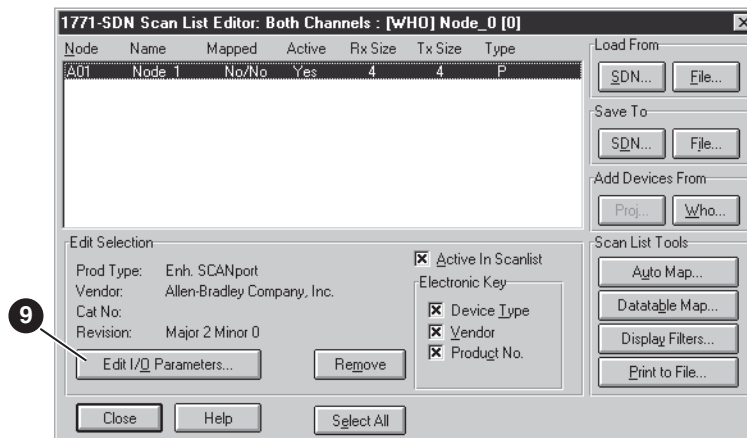

- Click **Edit I/O Parameters** to display the Edit Device I/O Parameters dialog box.

Figure 4.17

Edit Device I/O Parameters Dialog Box

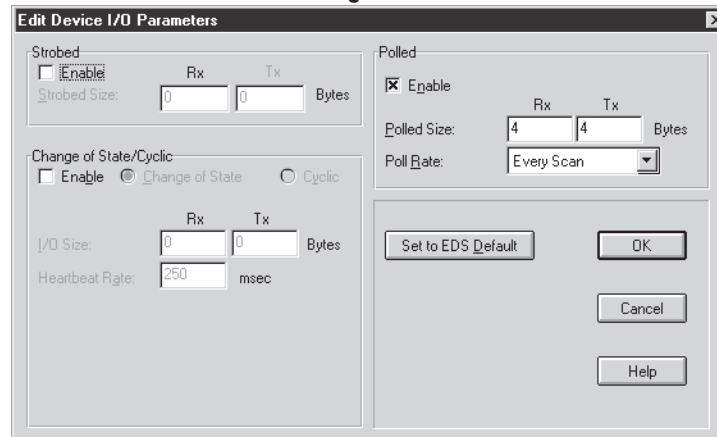

10. Under Polled, set the following:

Box	Setting
Enable	Select it. An X appears in it.
Polled Size	Type the number of bytes the adapter receives in the RX box and the number of bytes it transmits in the TX box. Important: To determine the number of bytes, use the following equation: 4 + (number of datalinks enabled x 4) = total bytes For example, if all four datalinks are enabled, you would type 20 in these boxes: 4 + (4 x 4) = 20.
Poll Rate	Select either every scan or background as a poll rate.

11. Click **OK**. A DeviceNet Manager message appears.

12. Click **Yes**. The 1771-SDN Scan List Editor: Both Channels dialog box reappears.

13. Click **Auto Map** to display the Auto Map Options dialog box.

Figure 4.18
Auto Map Options Dialog Box

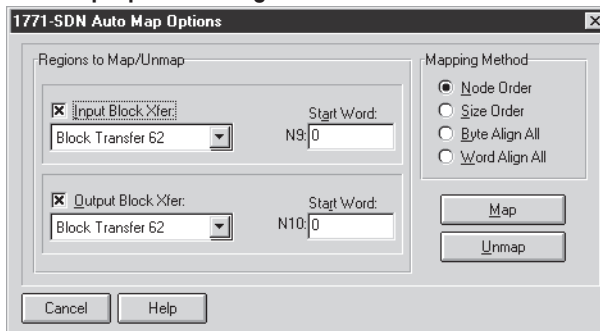

14. Select the following:

Box	Setting
Input Block Xfer	Select the location in the PLC to which messages from the 1203-GK5 module or 1336-GM5 board are sent.
Output Block Xfer	Select the location in the PLC from which messages to the 1203-GK5 module or 1336-GM5 board are sent.
Mapping Method	Select the mapping method.

Refer to the DeviceNet Manager online help for more information.

15. Click **Map**. The Scan List Editor: Both Channels dialog box reappears and Yes/Yes appears under Mapped.

Figure 4.19
Scan List Editor: Both Channels Dialog Box



16. Under Save To, click **SDN** to display the 1771-SDN Scan List Editor — Download dialog box.

Figure 4.20
1771-SDN Scan List Editor Download Dialog Box

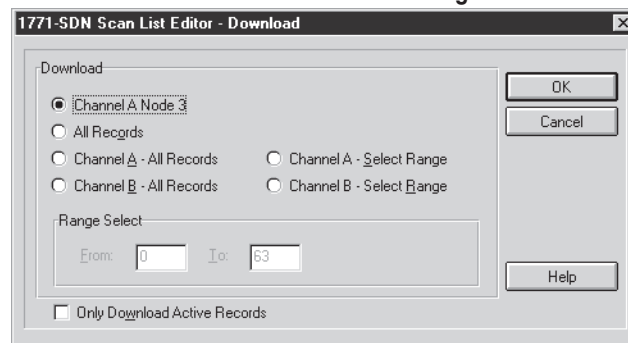

17. Select the records to download, and then click **OK** to download these records to the PLC. A DeviceNet Manager message appears.

Figure 4.21
DeviceNet Manager Message

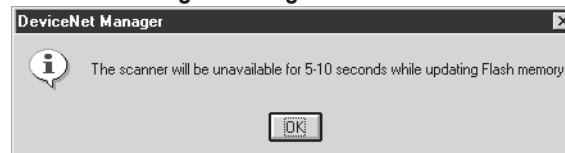

18. Click **OK**. When the download is complete, the 1771-SDN Scan List Editor: Both Channels dialog box appears.

The PLC is now configured to communicate with the product connected to the network with the 1203-GK5 module or 1336-GM5 board. Refer to the “Saving a Configuration to a File and Quitting DeviceNet Manager” on page 4-18.

Configuring an SLC Scanner (1747-SDN) to Communicate with a 1203-GK5 Module or 1336-GM5 Board

The following instructions describe how to configure an SLC scanner on a DeviceNet network.

Important: If you are using an PLC scanner (1771-SDN), refer to “Configuring a PLC Scanner (1771-SDN) to Communicate with a 1203-GK5 Module or 1336-GM5 Board” on page 4-8.

For the scanner to communicate with a product connected to the network with a 1203-GK5 module or 1336-GM5 board, the scanner must be properly configured and the product node number must be added to its scan list.

Important: In case you need to revert to the current mapping, you may want to retrieve and save existing mappings in the scanner to a file before adding the module to the scanner mapping.

To configure the SLC scanner to communicate with a 1203-GK5 module or 1336-GM5 board, follow these instructions:

1. Select **Who > Network Who** to display the Network Who screen. DeviceNet Manager immediately scans for devices on the network.

Important: To stop the scan, click **Stop**. You can click **Stop** at any time.

2. Double-click the scanner icon to display the 1747-SDN Module Configuration dialog box.

Figure 4.22
1747-SDN Module Configuration Dialog Box

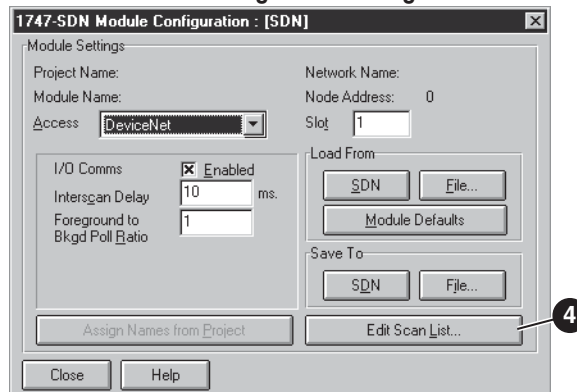

3. Verify the default values. Edit as necessary. Refer to the DeviceNet Manager online help for more information.

- Click **Edit Scan List** to display the 1747-SDN Scan List Editor dialog box.

Figure 4.23

1747-SDN Scan List Editor Dialog Box

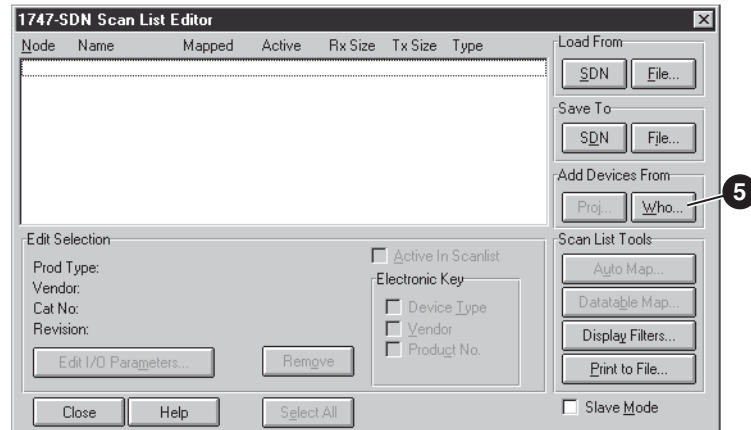

- Under Add Devices From, click **Who** to display the Add Devices to Scan List dialog box.

Figure 4.24

Add Devices to Scan List Dialog Box

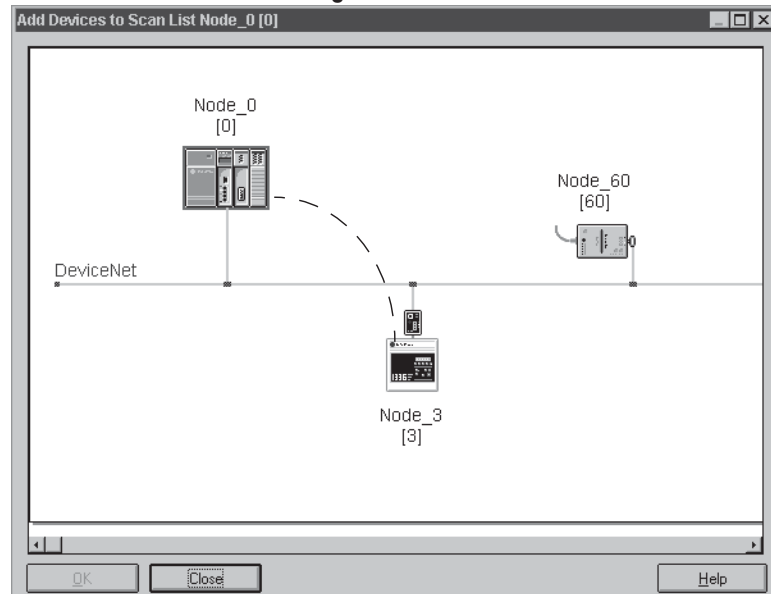

- Drag and drop the node that you want to add onto the scanner icon. The node that you are adding is outlined in red.

7. Click **OK** to display a dialog box similar to the following.

Figure 4.25
1747-SDN Scan List Editor Dialog Box

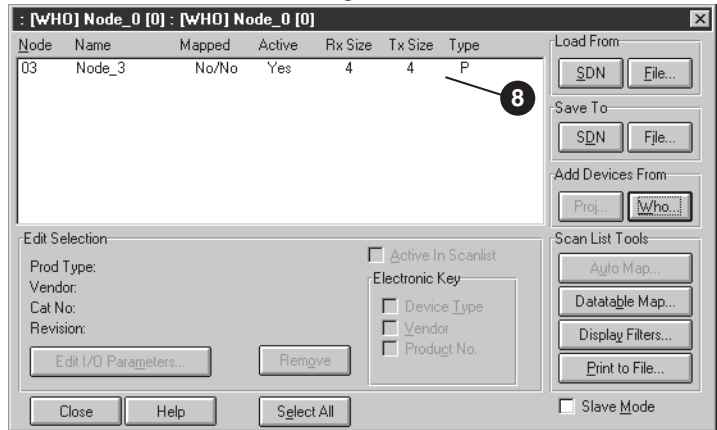

8. Click the row of the new node to highlight it.

Figure 4.26
1747-SDN Scan List Editor Dialog Box

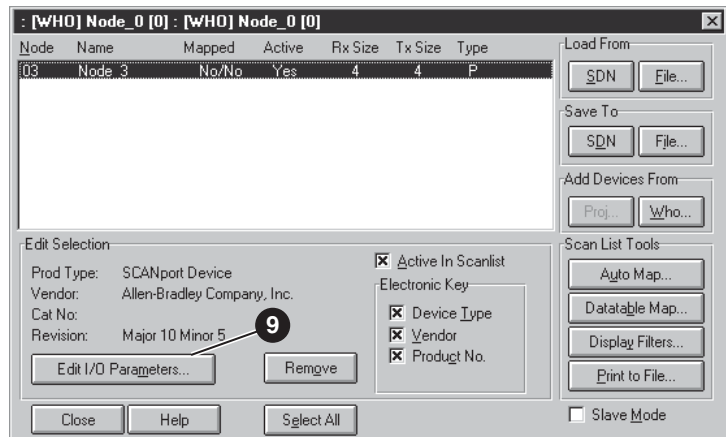

9. Click **Edit I/O Parameters** to display the Edit Device I/O Parameters dialog box.

Figure 4.27
Edit Device I/O Parameters Dialog Box

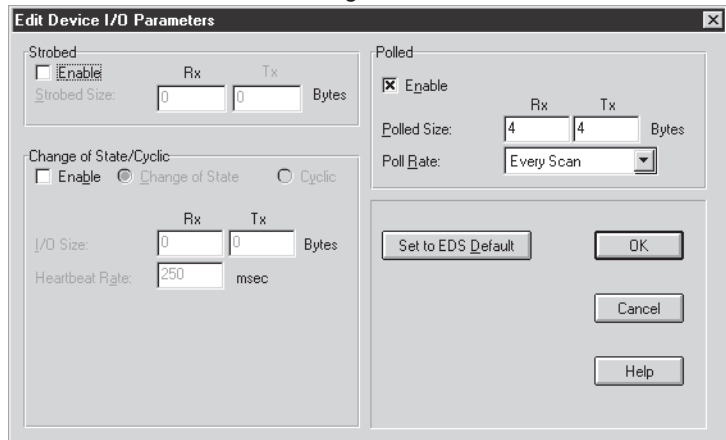

10. Under Polled, set the following:

Box	Setting
Enable	Select it. An X appears in it.
Polled Size	Type the number of bytes the adapter receives in the RX box and the number of bytes it transmits in the TX box. Important: To determine the number of bytes, use the following equation: $4 + (\text{number of datalinks enabled} \times 4) = \text{total bytes}$ For example, if all four datalinks are enabled, you would type 20 in these boxes: $4 + (4 \times 4) = 20.$
Poll Rate	Select a poll rate.

11. Click **OK**. A DeviceNet Manager message appears.

Figure 4.28
DeviceNet Manager Message

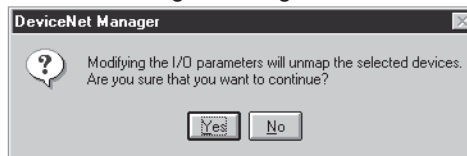

12. Click **Yes** to display a dialog box similar to the following.

Figure 4.29
1747-SDN Scan List Editor Dialog Box

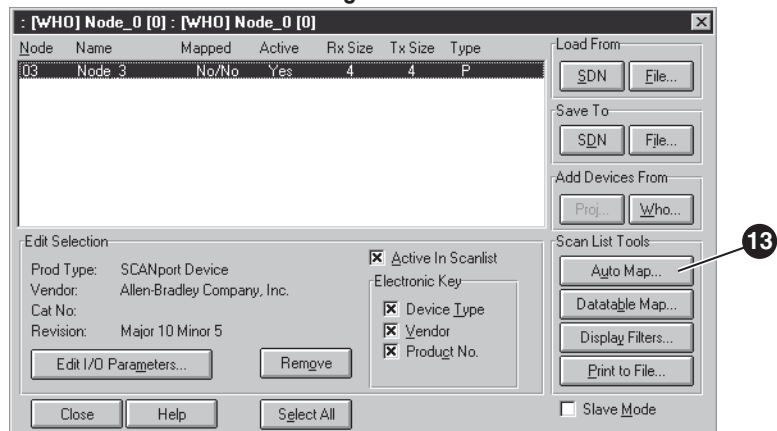

13. Under Scan List Tools, click **Auto Map** to display the Auto Map Options dialog box.

Figure 4.30
1747-SDN Auto Map Options Dialog Box

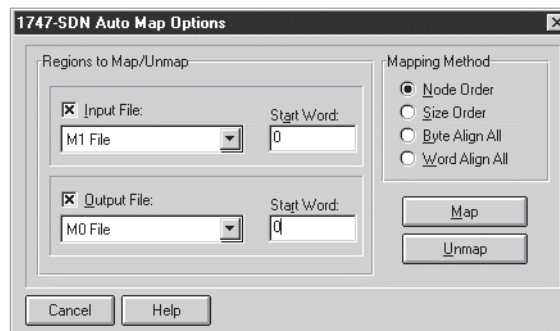

14. Select the following:

Box	Setting
Input File	Select the location in the SLC to which messages from the 1203-GK5 module or 1336-GM5 board are sent.
Output File	Select the location in the SLC from which messages to the 1203-GK5 module or 1336-GM5 board are sent.
Mapping Method	Select the mapping method.

Refer to the DeviceNet Manager online help for more information.

15. Click **Map** to display a dialog box similar to the following.

Figure 4.31
1747-SDN Scan List Editor Dialog Box



16. Under Save To, click **SDN** to display the 1747-SDN Scan List Editor — Download dialog box.

Figure 4.32
1747-SDN Scan List Editor — Download Dialog Box

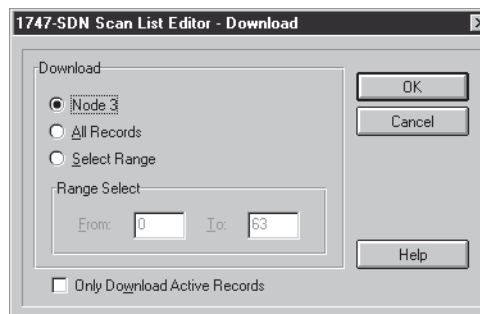

17. Select the records to download, and then click **OK**. A DeviceNet Manager Message appears.

Figure 4.33
DeviceNet Manager Message

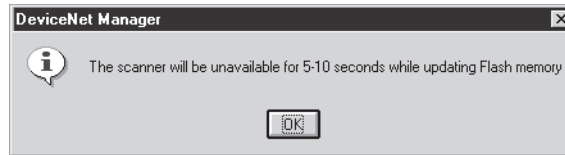

18. Click **OK** to download the new configuration to the SLC. The 1747-SDN Scan List Editor dialog box reappears.

The SLC is now configured to communicate with the product connected to the network with the 1203-GK5 module or 1336-GM5 board. Refer to the “Saving a Configuration to a File and Quitting DeviceNet Manager” on page 4-18.

Saving a Configuration to a File and Quitting DeviceNet Manager

After a configuration is downloaded to a controller, you have the option of saving it to a disk file. It is recommended that you do save it to a disk file as you quit DeviceNet Manager so that you have a backup file on your computer. Follow these instructions:

You begin the process of saving the file in the Scan List Editor dialog box.

Figure 4.34
Example Scan List Editor Dialog Box

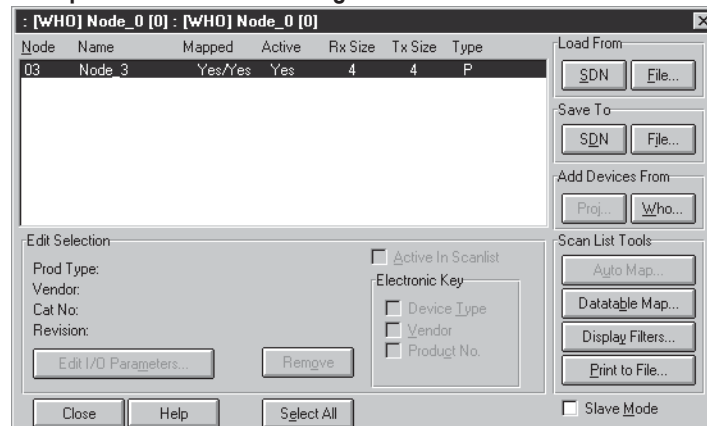

1. Click **Close** to close the Scan List Editor dialog box. A DeviceNet Manager message appears.

Figure 4.35
DeviceNet Manager Message

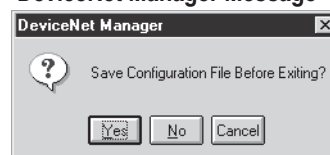

- Click **Yes** to display the Save As dialog box.

Figure 4.36
Save As Dialog Box

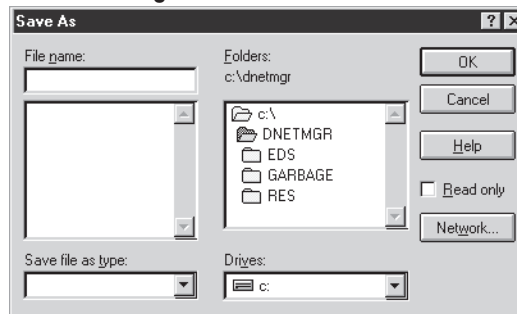

- In the File name box, type a name for the file.
- In the Save File as type box, select the appropriate extension:

If Using:	File Extension:
PLC Scanner (1771-SDN)	.SL7
SLC Scanner (1747-SDN)	.SL4

- Click **OK** to save the file. The Module and Channel Configuration dialog box appears.
- Click **Close** to close the Module and Channel Configuration dialog box. A DeviceNet Manager message appears.

Figure 4.37
DeviceNet Manager Message

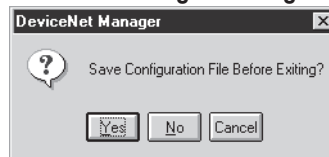

- Click **Yes** to display the Save As dialog box.

Figure 4.38
Save As Dialog Box

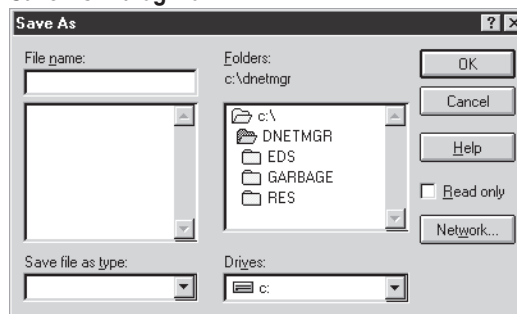

- In the File name box, type a name for the file.

9. In the Save File as type box, select the appropriate extension:

If Using:	File Extension:
PLC Scanner (1771-SDN)	.SL7
SLC Scanner (1747-SDN)	.SL4

10. Click **OK** to save the file. The Network WHO screen appears.

11. Click **Close** to close the Network WHO screen.

12. Exit DeviceNet Manager.

Your device is now configured on the DeviceNet network. The network LED on the module is solid green. Refer to Chapter 5, *Creating a Ladder Logic Program*, for information on creating a PLC Ladder Logic Program.

Important: If the network LED is not solid green, refer to Chapter 7, *Troubleshooting*.

Viewing and Editing Parameters

You may need to view or edit a parameter value in an adapter (e.g., 1203-GK5 module or 1336-GM5 board) or in a product (e.g., 1336 PLUS drive) with DeviceNet Manager. Follow these instructions:

1. Select **Who > Network Who** to display the Network Who screen. DeviceNet Manager immediately scans for devices on the network.

Important: To stop the scan, click **Stop**. You can click **Stop** at any time.

2. Double-click the icon for the node whose parameters you want to edit. The Device Configuration dialog box appears.

Important: If a DeviceNet Manager message asking you to create an EDS file appears, refer to “Creating an EDS File for the Adapter and Product” on page 4-4.

Figure 4.39
Device Configuration — Enhanced Mode Dialog Box

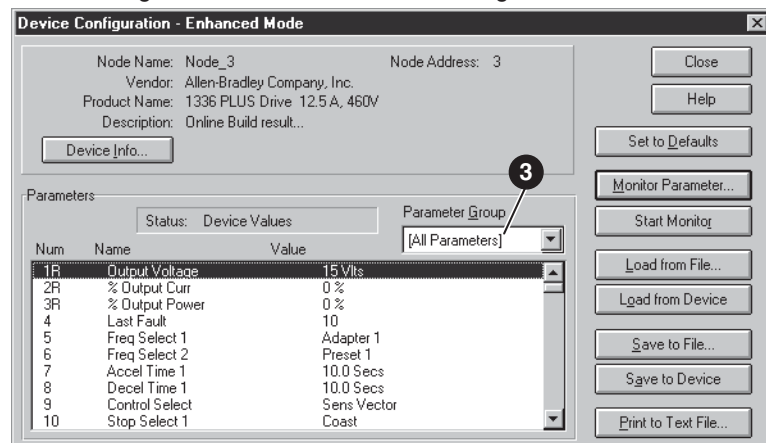

- Click on the Parameter Group box and select the desired group.

Important: Select DeviceNet Module to view and edit parameters in the 1203-GK5 module or 1336-GM5 board. Parameter numbers vary based on the number of product parameters.

Figure 4.40
Device Configuration — Enhanced Mode Dialog Box

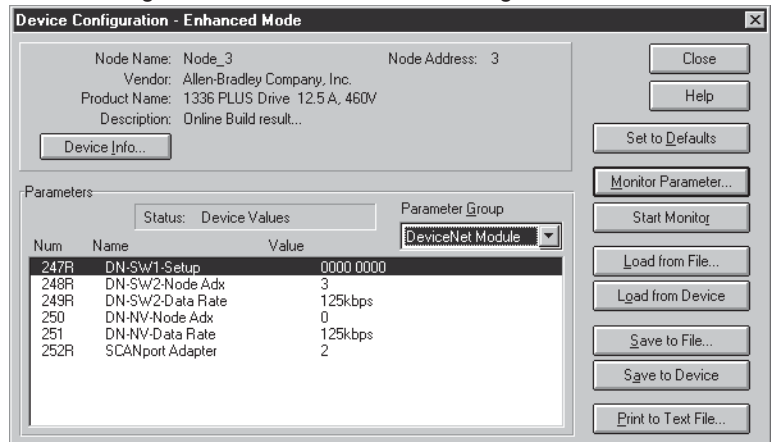

- Double-click the parameter(s) that you want to edit. A dialog box similar to the following appears.

Figure 4.41
Example Device Configuration Dialog Box

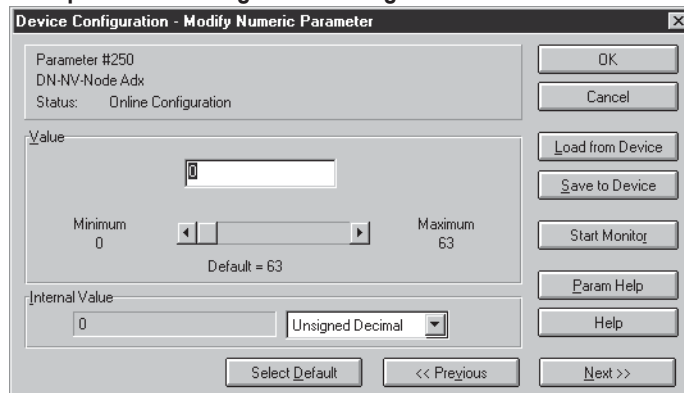

- Edit values as desired.
- Click **Save to Device** to save the changes.
- Click **OK** to close the Device Configuration dialog box.
- Click **Close** to close the Device Configuration — Enhanced Mode dialog box.
- Click **Close** to close the Network Who screen.

Important: For edits to parameters to take effect in some products and adapter, you must power cycle the module or product.

This Page Intentionally Left Blank.

Creating a Ladder Logic Program

Chapter Objectives

Chapter 5 provides information needed to create the PLC or SLC Ladder Logic program that the controller will use to transmit control I/O and messages to and from the product connected to the 1203-GK5 module or 1336-GM5 board. In this chapter, you will read about the following:

- Equipment and software needed to create either a PLC or SLC ladder logic program.
- Example PLC and SLC ladder logic programs to control the drive.

This chapter assumes you are familiar with the hardware components and programming procedures necessary to create a ladder logic program for a PLC-5 or SLC-5/03[®]. It also assumes that you have experience using RSLogix 5 or RSLogix500 to create ladder logic programs.

You may need to refer to the documentation provided with your controller or scanner to develop a ladder logic program.

Required Equipment

Before creating a ladder logic program for the PLC or SLC, your computer must be:

- Running RSLogix5 and RSLinx if using a PLC.
- Running RSLogix500 and RSLinx if using an SLC.
- Connected to and communicating with the PLC or SLC using a network such as a DH+[™], DH485, or ControlNet[™]. Your computer needs a network card to connect to one of these networks. For example, a 1784-KTX card is used to connect to a DH+ network, and a 1784-KTC card is used to connect to a ControlNet network.

About RSLogix

RSLogix5 (for the PLC-5) and RSLogix500 (for the SLC-5/03) software let you create ladder logic programs and download them to the PLC or SLC. These applications also let you monitor the ladder logic program as the PLC or SLC is using it.

For more information on RSLogix5 or RSLogix500, consult the respective software documentation or visit <http://www.software.rockwell.com>.

About Ladder Logic Programs

A PLC or SLC ladder logic program lets you control the drive and the messaging from the PLC or SLC on the DeviceNet network. Figure 5.1 shows how the I/O image table for a DeviceNet scanner relates to the drive when a 1203-GK5 module or 1336-GM5 board is used.

Important: Figure 5.1 shows all datalinks enabled. Users must enable the desired datalinks in the adapter and connected product.

Figure 5.1
I/O Image Table

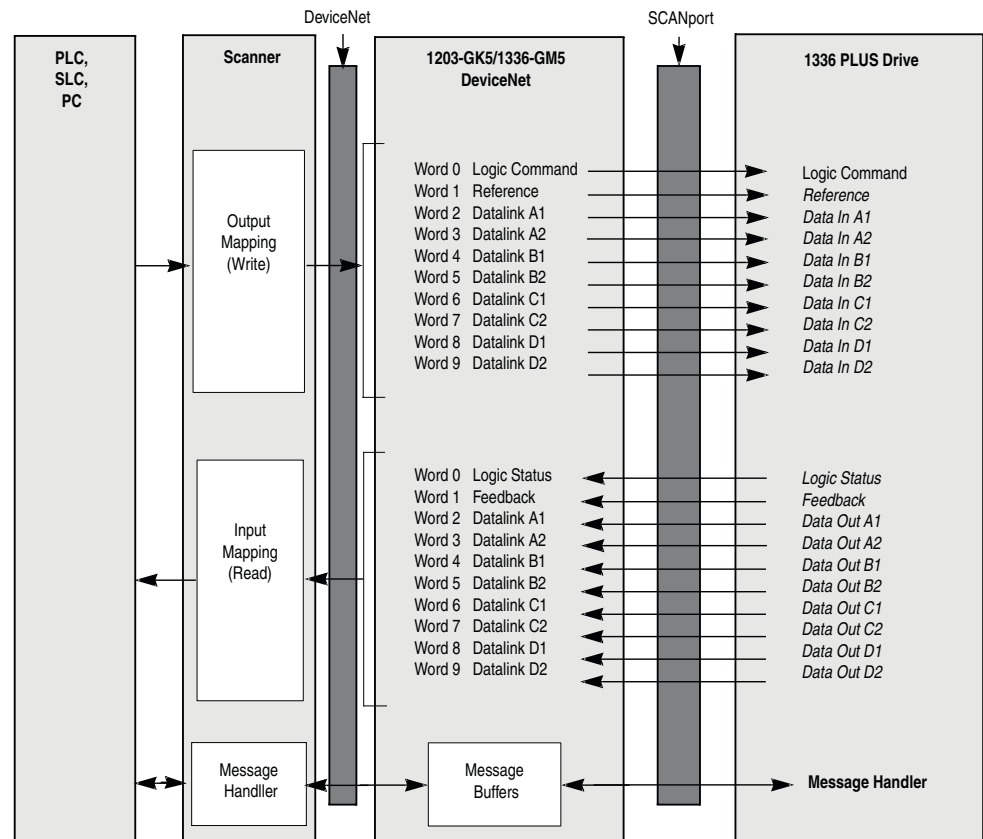

Example Ladder Logic Programs

The following are example ladder logic programs. They can be used for a 1305, 1336 PLUS, or 1336 PLUS II drive.



ATTENTION: The example ladder logic program shown in this manual is intended solely for purpose of example. Because there are many variables and requirements associated with any particular installation, Rockwell Automation does not assume responsibility or liability (to include intellectual property liability) for actual use based upon the example shown in this publication.

Important: Different SCANport products have different Logic Command, Logic Status, Reference and Feedback I/O interpretations. Refer to your product manual for specific I/O definitions.

The 1305, 1336 PLUS, or 1336 PLUS II drive in this example accepts the following Logic Command Data from the controller.

Logic Command Bits																Function	Description
15	14	13	12	11	10	9	8	7	6	5	4	3	2	1	0		
															X	Stop	1=Stop, 0=No Operation
														X		Start	1=Start, 0=No Operation
													X			Jog	1=Jog, 0=No Operation
											X					Clear Faults	1=Clear, 0=No Operation
									X	X						Direction	00=No Operation, 01=Forward, 10=Reverse
								X								Local	1=Local, 0=Multiplexed
							X									MOP Increment	1=Increment MOP, 0=No Operation
						X	X									Accel Rate Select	00=No Operation, 01=Rate 1, 10=Rate 2
				X	X											Decel Rate Select	00=No Operation, 01=Rate 1, 10=Rate 2
	X	X	X													Reference Selection	000=No Operation 001=External Reference 1 (Par 5) 010=External Reference 2 (Par 6) 011=Preset 3 100=Preset 4 101=Preset 5 110=Preset 6 111=Preset 7
X																MOP Decrement	1=Decrement MOP, 0=No Operation

The 1305, 1336 PLUS, or 1336 PLUS II drive in this example sends the following Logic Status Data to the PLC.

Logic Status Bits																Function	Description
15	14	13	12	11	10	9	8	7	6	5	4	3	2	1	0		
															X	Enabled	1=Enabled, 0=Not Enabled
														X		Running	1=Running, 0=Not Running
												X				Command Direction	1=Forward, 0=Reverse
											X					Rotating Direction	1=Forward, 0=Reverse
										X						Acceleration	1=Accelerating, 0=Not
									X							Deceleration	1=Decelerating, 0=Not
								X								Warning	1=Warning Present, 0=Not
							X									Fault	1=Faulted, 0=Not Faulted
						X										At Speed	1=At Speed, 0=Not At Speed
				X	X	X										Local	000=Terminal I/O has Local 001=Port 1 has Local 010=Port 2 has Local 011=Port 3 has Local 100=Port 4 has Local 101=Port 5 has Local 110=Port 6 has Local 111=Multiplexed Control
X	X	X	X													Reference Source	0000=External Reference 1 0001 – 0111=Presets 1 – 7 1000=External Reference 2 1001 – 1110=Port 1 – 6 Direction 1111=Jog

PLC Ladder Logic Example

In the following example, a PLC-5, 1771-SDN DeviceNet scanner, and 1203-GK5 module (or 1336-GM5 board) are used to control a 1305, 1336 PLUS, or 1336 PLUS II drive.

The example program shows how to obtain status information from the drive and how to control it (e.g., starting the drive, stopping the drive, jogging the drive, sending reference, and clearing faults). When you understand this example, you should be able to customize the program to fit you application needs.

The example assumes that there is an operator's station wired to an I/O module in slot zero of module group zero of rack zero.

Important: You may want to verify a device has not failed using word 0 of block transfer 62 before sending control data. If a device has failed, use block transfer 52 to find out which device failed. Refer to the *1771-SDN DeviceNet Scanner Module Manual*, Publication 1771-5.14, for more information.

Figure 5.2
Example PLC Ladder Logic Program

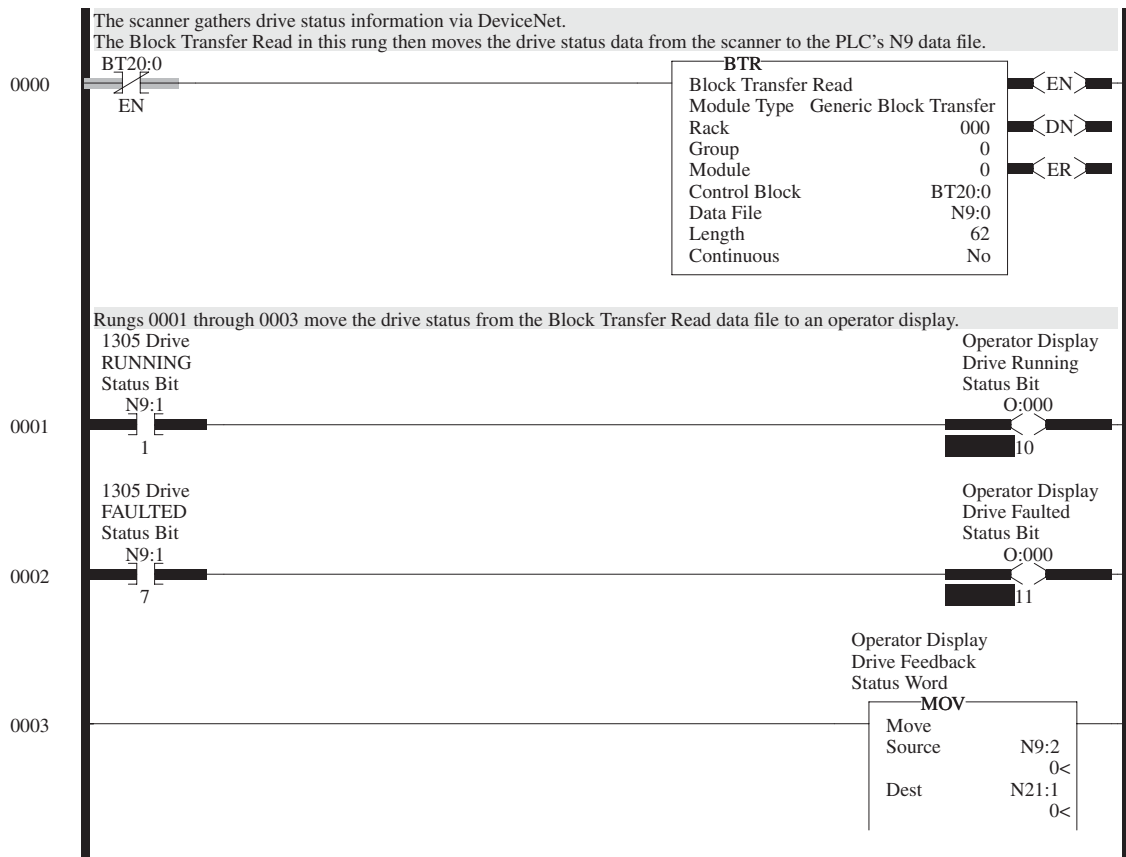
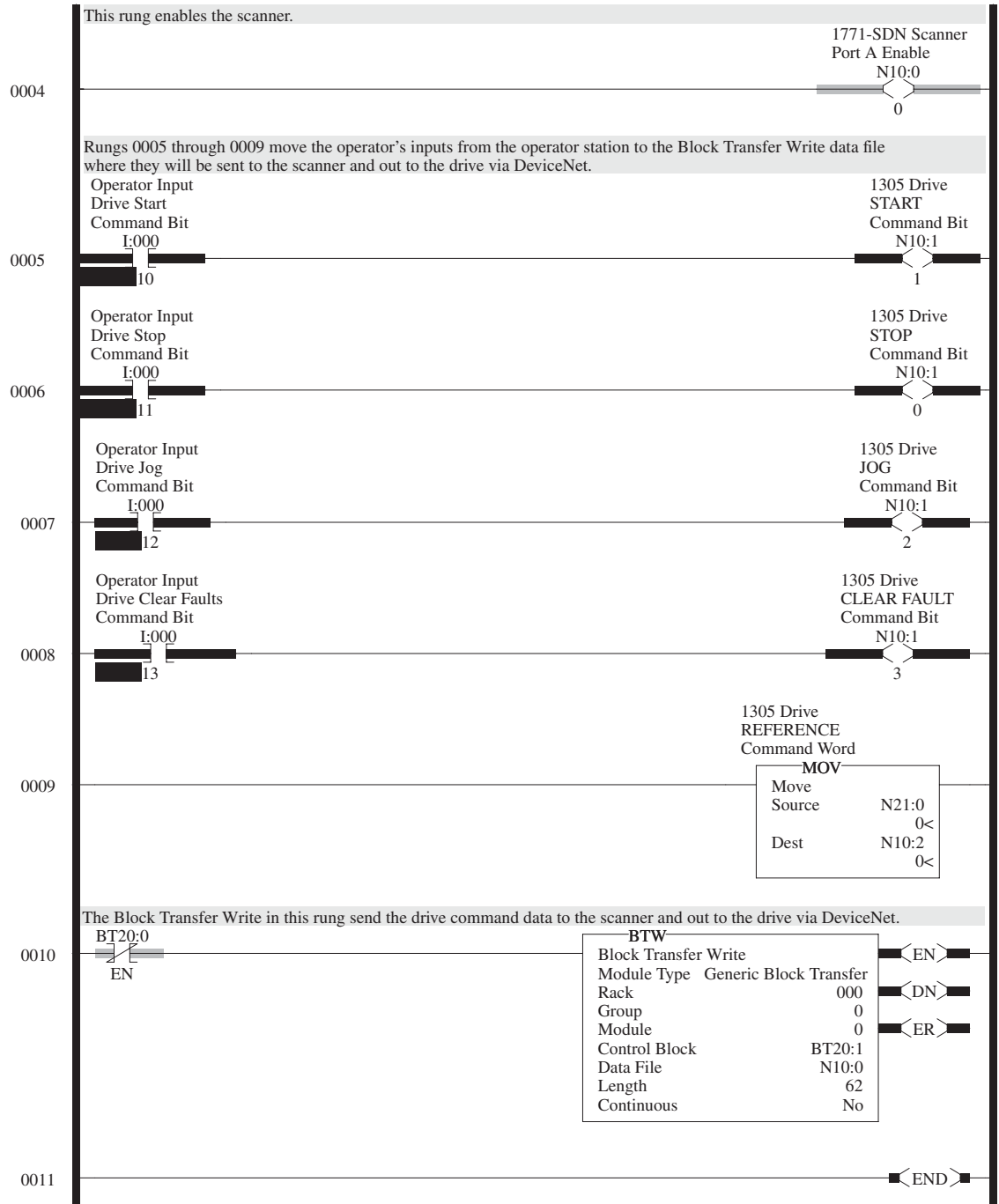

Figure 5.2
Example PLC Ladder Logic Program (Continued)



The following table represents the control file for the block transfers.

Offset	EN	ST	DN	ER	CO	EW	NR	TO	RW	RLEN	DLEN	FILE	ELEM	R	G	S
BT20:0	0	0	0	0	0	0	0	0	0	62	0	9	0	00	0	0
BT20:1	0	0	0	0	0	0	0	0	0	62	0	10	0	00	0	0

SLC Ladder Logic Program Example

In the following example, an SLC-5/03, 1747-SDN DeviceNet scanner, and a 1203-GK5 module (or 1336-GM5 board) control a 1305, 1336 PLUS, or 1336 PLUS II drive.

The example assumes that there is an operator's station wired to an I/O module in slot one of module group zero of rack zero.

Important: You may want to verify a device has not failed using word I:S.0. If a device has failed, read the appropriate M1 File to find out which device failed. Refer to the *1747-SDN DeviceNet Scanner Module Manual*, Publication 1747-5.8, for more information.

Figure 5.3
Example SLC Ladder Logic Program

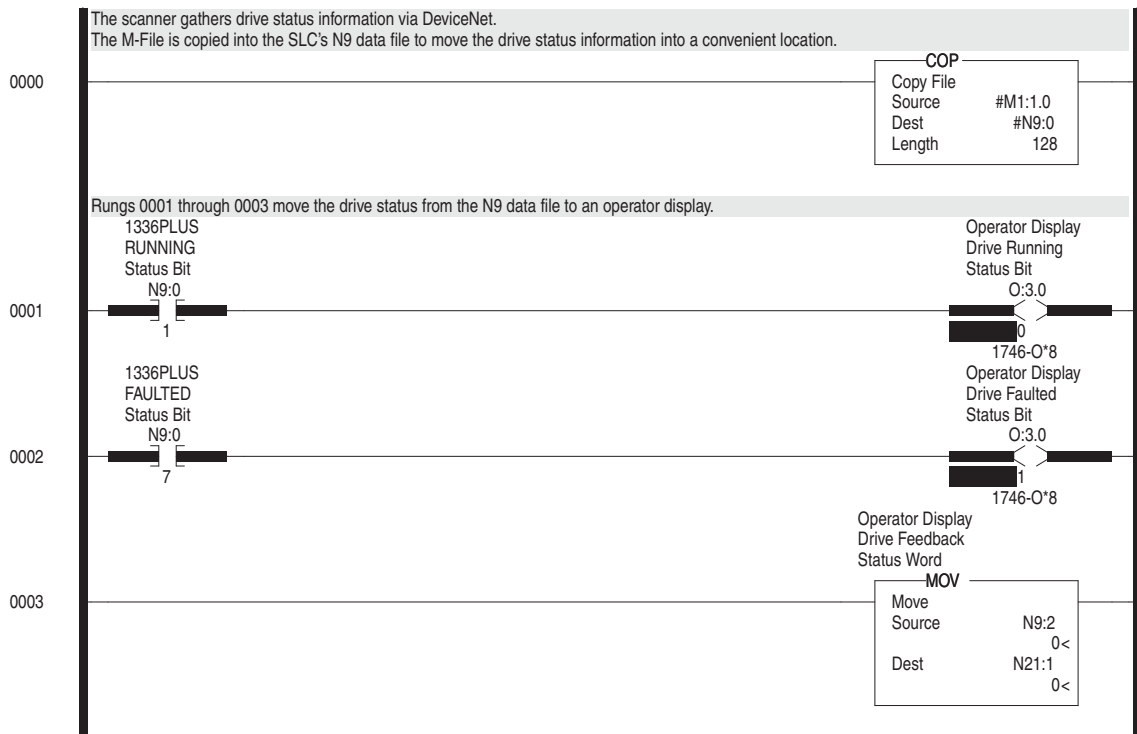
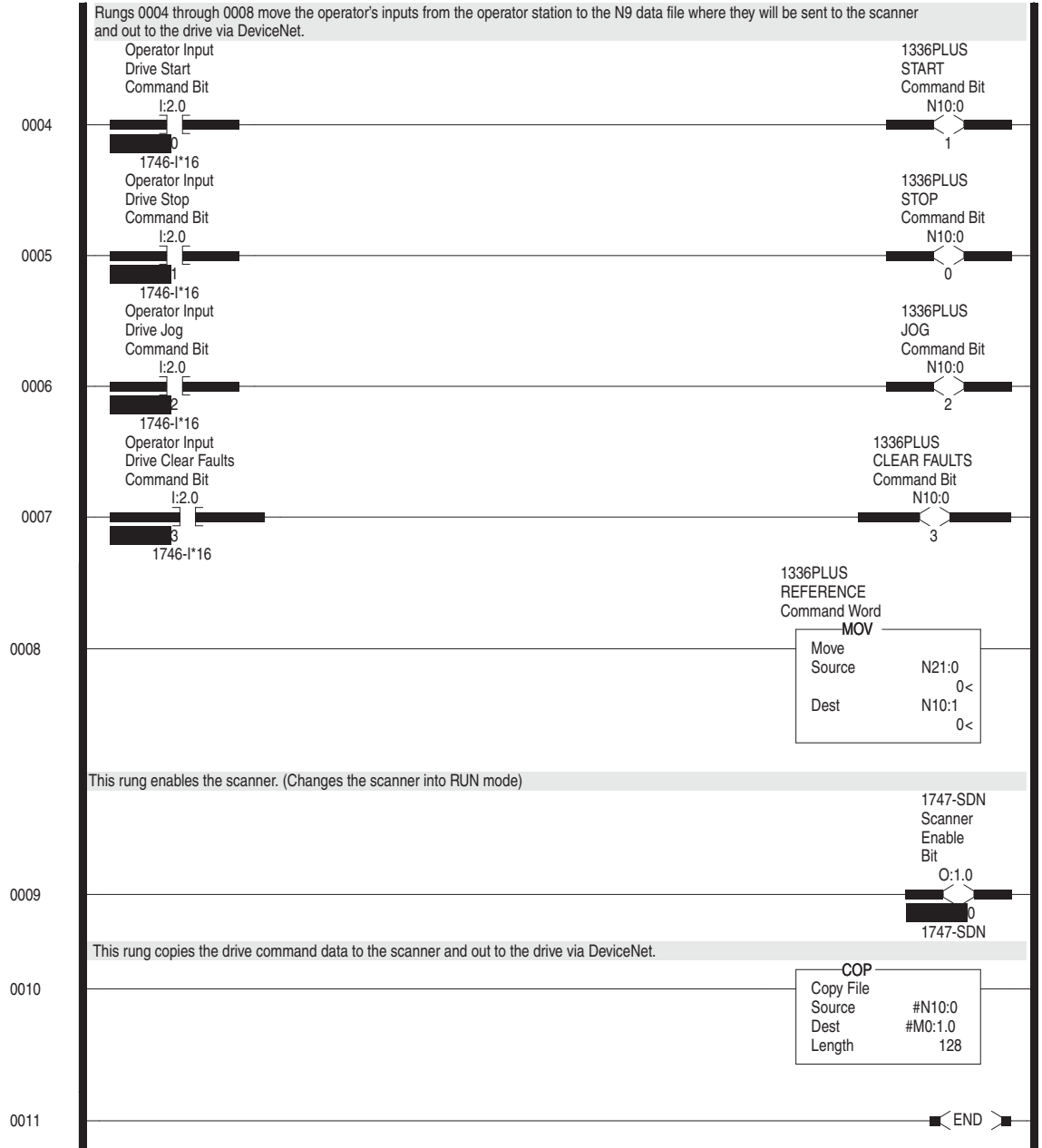

Figure 5.3
Example SLC Ladder Logic Program (Continued)



This Page Intentionally Left Blank.

Using DeviceNet Explicit Messages

Chapter Objectives

Chapter 6 provides information you need to monitor and configure the SCANport device using explicit messaging on DeviceNet. In this chapter, you will read about the following:

- Required equipment.
- Message translations.
- Messaging guidelines for SLC and PLC scanners.
- Example messages.
- Using messages to control SCANport products.
- Writing to register objects.

Refer to Appendix C, *DeviceNet Objects*, for information on object data support.

Required Equipment

Before writing messaging ladder logic, your computer must be:

- Running Logix5 and RSLinx if you are using a PLC.
- Running RSLogix500 and RSLinx if you are using an SLC.
- Connected to and communicating with the PLC or SLC using a network such as a DH+, DH485, or ControlNet. Your computer needs a network card to connect to one of these networks. For example, a 1784-KTX card is used to connect to a DH+ network, and a 1784-KTC card is used to connect to a ControlNet network.

Important: For information about RSLogix, refer to Chapter 5, *Creating a Ladder Logic Program*.

Message Translations

The 1203-GK5 module or 1336-GM5 board electronically translates DeviceNet explicit messages into SCANport messages and back. The format of all explicit messages supported by the adapter is 8:16. The class field is 8 bits long, and the instance field is 16 bits long.



ATTENTION: Hazard of equipment damage exists. If explicit messages are programmed to frequently write parameter data to certain drive products, the EEPROM (Non-Volatile Storage) will quickly exceed its life cycle and cause the product to malfunction. Do not create a program that frequently uses explicit messages to write parameter data to a product. Datalinks do not write to the EEPROM and should be used for frequently changed parameters.

Messaging for the 1771-SDN Scanner

The PLC uses a 64-word Block Transfer Write (BTW) to copy an Explicit Message into the 1771-SDN scanner. Ten explicit message buffers are available within the 1771-SDN scanner. When the BTW completes, the scanner executes the message. The PLC must then poll the scanner by performing a 64-word Block Transfer Read (BTR) to complete the message. (Note that the PLC can transfer two Explicit Messages per BTW or BTR and the scanner can have up to 10 Explicit Messages active at any time.)

When the BTR completes, the data received by the PLC will contain information about the status of the current Explicit Message being processed by the scanner. If an Explicit Message has completed, the STATUS code in the Explicit Message Response is set to 1 and the response message contains the data requested.

If the message status indicates that it is not completed, the BTR should be repeated until the message is complete.

The format of Request and Response messages is in Figure 6.1.

Figure 6.1
Format of DeviceNet Messages

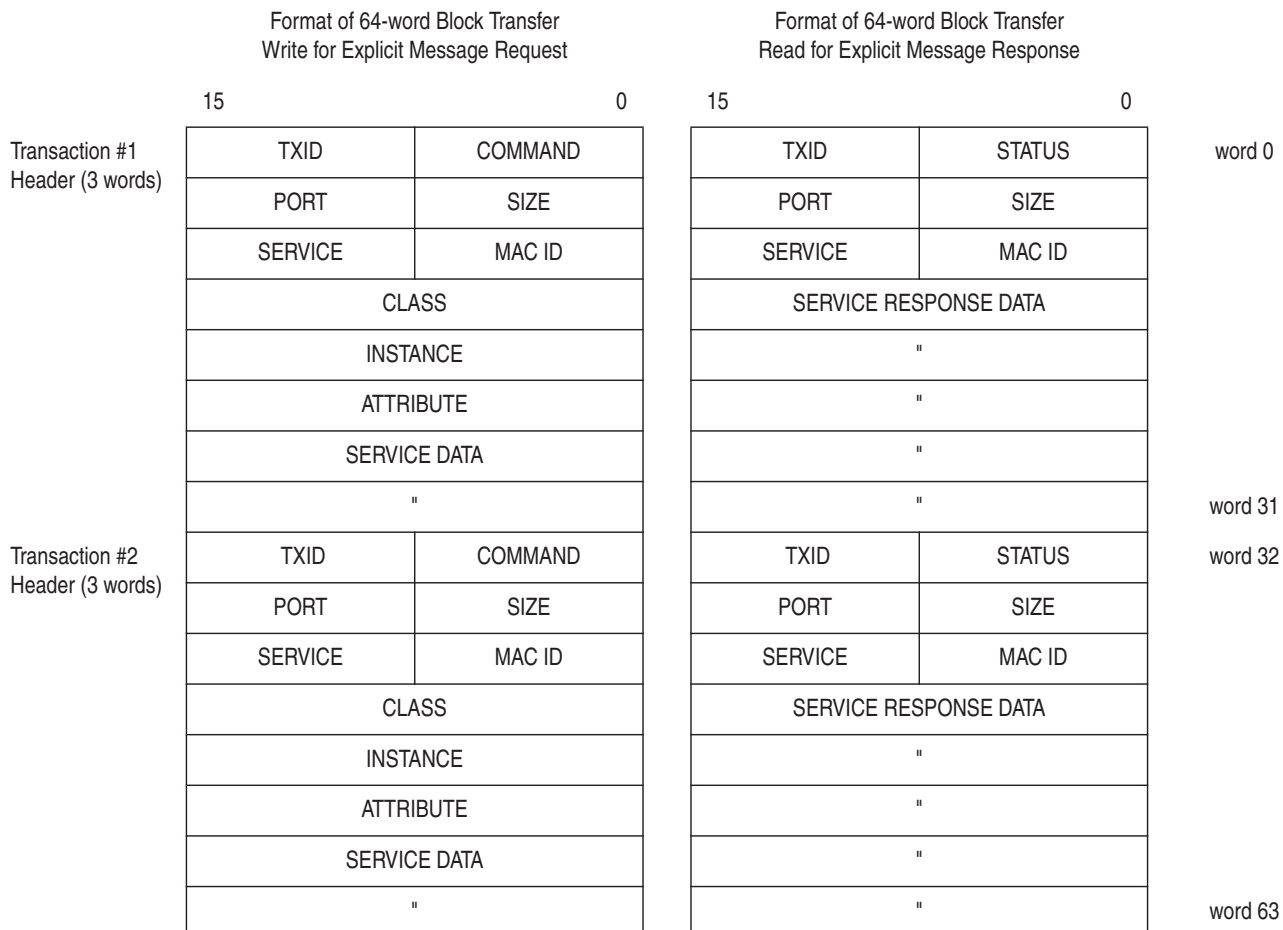

Transaction Blocks are divided into two parts:

- **Transaction header** — contains information that identifies the transaction to the scanner and processor.
- **Transaction body** — in a request, this contains the DeviceNet Class, Instance, Attribute and Service Data portion of the transaction. In a response, this contains the Service Data only.

Each of the data attributes in the transaction header are one byte in length:

Data Field	Description
TXID	Transaction ID — when the processor creates and downloads a request to the scanner, the processor's ladder logic program assigns a TXID to the transaction. This is a one-byte integer in word 31 the range of 1 to 255. The scanner uses this value to track the transaction to completion, and returns the value with the response that matches the request downloaded by the processor.
COMMAND	In each message request, a command code instructs the scanner how to administer the request: 0 = Ignore transaction block (block empty) 1 = Execute this transaction block 2 = Get status of transaction TXID 3 = Reset all client/server transactions 4-255 = Reserved
STATUS	In each message response, the status code provides the processor with status on the device and its response: 0 = Ignore transaction block (block empty) 1 = Transaction completed successfully 2 = Transaction in progress (not ready) 3 = Error — slave not in scan list 4 = Error — slave off-line 5 = Error — DeviceNet port disabled or off-line 6 = Error — transaction TXID unknown 7 = Unused 8 = Error — Invalid command code 9 = Error — Scanner out of buffers 10 = Error — Other client/server transaction in progress 11 = Error — could not connect to slave device 12 = Error — response data too large for block 13 = Error — invalid port 14 = Error — invalid size specified 15 = Error — connection busy 16-255 = Reserved
PORT	The DeviceNet port where the transaction is routed. The port can be zero (Channel A) or one (Channel B) on a 1771-SDN scanner.
SIZE	The size of the transaction body in bytes. The transaction body can be up to 29 words (58 bytes) in length. If the size exceeds 29 words, an error code will be returned.
SERVICE	The service attribute contains the DeviceNet service request and response codes that match the corresponding request for the TXID.
MAC ID	The DeviceNet network address of the slave device where the transaction is sent. This value can range from 0 to 63. The port and MAC ID attributes coupled together identify the target slave device. The slave device must be listed in the scanner module's scan list and be on-line for the Explicit Message transaction to be completed.

Messaging for the 1747-SDN Scanner

The SLC copies an Explicit Message into the scanner's M0-file. When the copy is completed the scanner moves the message into a queue for processing. Up to 10 Explicit Messages can be in this queue.

When the scanner receives a response message it is placed into a queue. The first response in the queue is available from the M1-file. When the message delete command is copied into the scanner the message is complete and the next available response will appear in the M1-file.

The format of Request and Response messages is in Figure 6.2.

Figure 6.2
Format of DeviceNet Messages

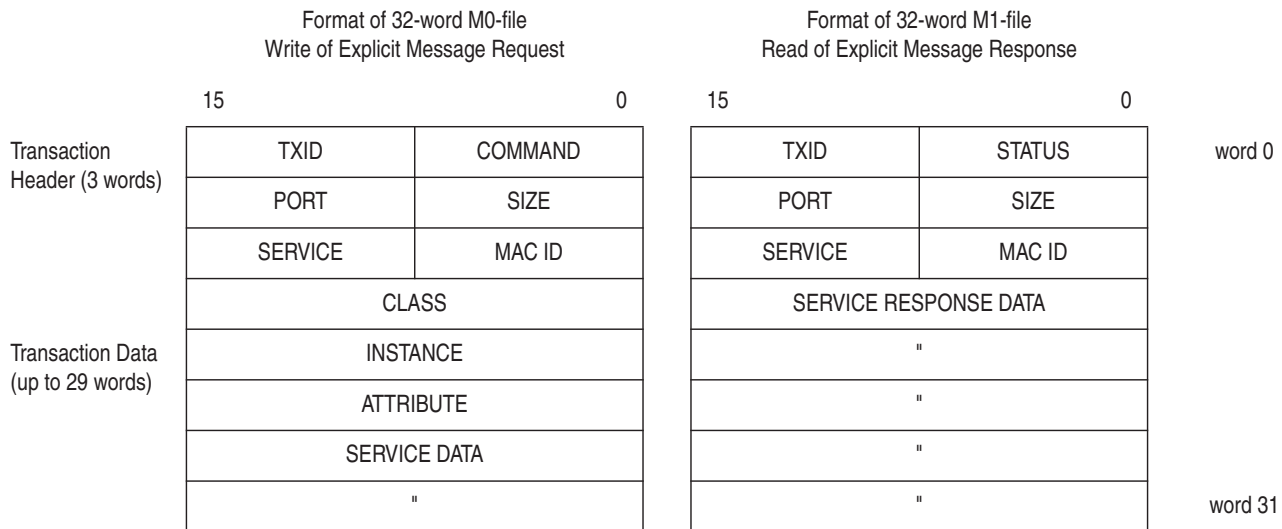

For information on M-File locations, refer to the *1747-SDN DeviceNet Scanner Module Manual*, Publication 1747-5.8.

The message buffer is composed of two sections:

- **Transaction header** — three words that contain information identifying the message transaction.
- **Transaction body** — in a request, this contains the DeviceNet Class, Instance, Attribute and Service Data portions of the transaction. In a response, this contains the Service Data only.

Each of the data fields in the transaction header are one byte in length:

Data Field	Description
TXID	Transaction ID — when the processor creates and downloads a request to the scanner, the processor's ladder logic program assigns a TXID to the transaction. This is a one-byte integer in word 31 the range of 1 to 255. The scanner uses this value to track the transaction to completion, and returns the value with the response that matches the request downloaded by the processor.
COMMAND	For each download, a command code instructs the scanner how to administer the request: 0 = Ignore transaction block (block empty) 1 = Execute this transaction block 2 = Get status of transaction TXID 3 = Reset all client/server transactions 4 = Delete this transaction block 5-255 = Reserved
STATUS	For each upload, the status code provides the processor with status on the device and its response: 0 = Ignore transaction block (block empty) 1 = Transaction completed successfully 2 = Transaction in progress (not ready) 3 = Error — Slave not in scan list 4 = Error — Slave off-line 5 = Error — DeviceNet port disabled or off-line 6 = Error — Transaction TXID unknown 7 = Unused 8 = Error — Invalid command code 9 = Error — Scanner out of buffers 10 = Error — Other client/server transaction in progress 11 = Error — Could not connect to slave device 12 = Error — Response data too large for block 13 = Error — Invalid port 14 = Error — Invalid size specified 15 = Error — Connection busy 16-255 = Reserved
PORT	The DeviceNet port used by this message. The port must be zero (Channel A) on a 1747-SDN scanner.
SIZE	The size of the transaction body in bytes. The transaction body can be up to 29 words (58 bytes) in length. If the size exceeds 29 words, an error code will be returned.
SERVICE	The service attribute contains the DeviceNet service request and response codes that match the corresponding request for the TXID.
MAC ID	The DeviceNet network address of the slave device where the transaction is sent. This value can range from 0 to 63. The port and MAC ID uniquely identify the target slave device. The slave device must be listed in the scanner module's scan list and be on-line for the Explicit Message transaction to be completed.

Examples

The following examples show messages used with the ladder logic programs begun in Chapter 5, *Creating a Ladder Logic Program*.



ATTENTION: The example ladder logic program shown in this manual is intended solely for purpose of example. Because there are many variables and requirements associated with any particular installation, Rockwell Automation does not assume responsibility or liability (to include intellectual property liability) for actual use based upon the example shown in this publication.

PLC Messaging

Figure 6.3, started in Chapter 5, *Creating a Ladder Logic Program*, shows an example PLC ladder logic program that sends an explicit message. The message sent is contained in N30, beginning at word 0. The response data will appear in N30 starting at word 70.

Figure 6.3
PLC Messaging Example

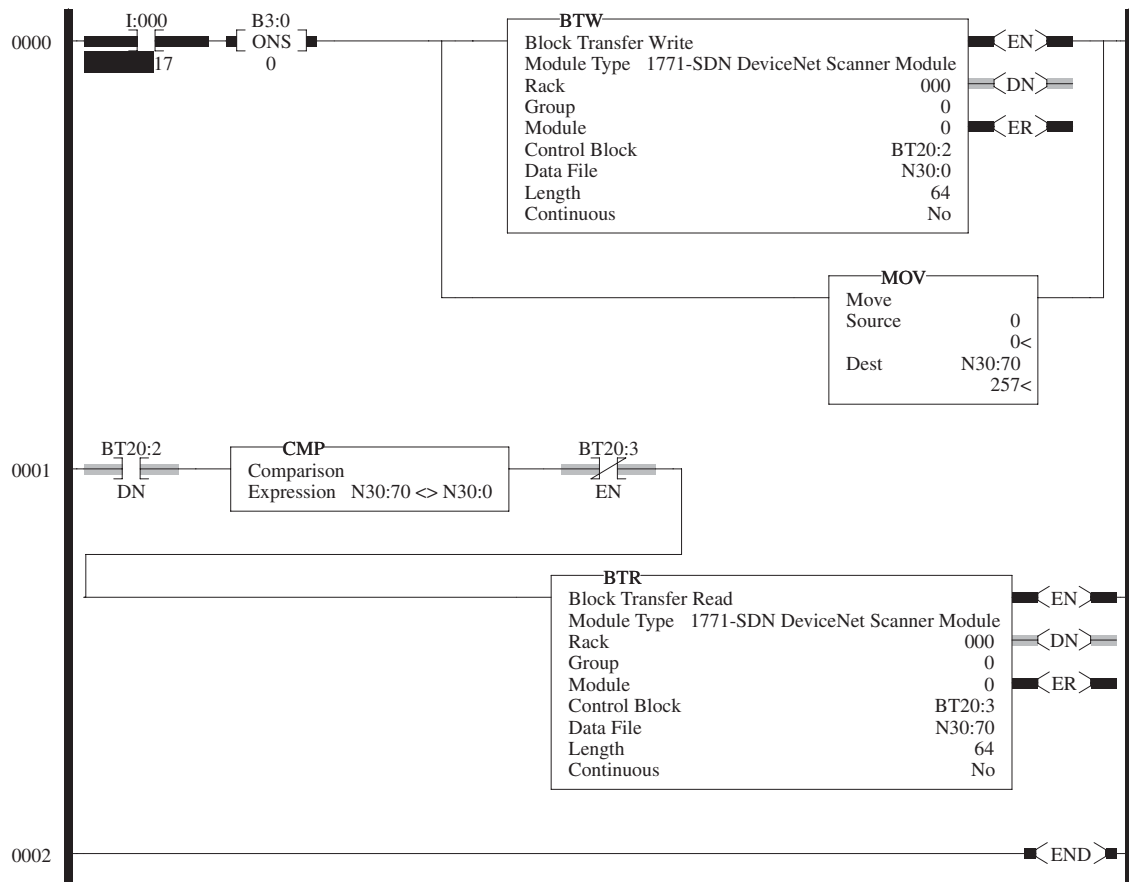

I:000/17: When you set this instruction to the true state, the next instruction, a one-shot block transfer write, sends data to the scanner. The Move instruction then initializes the first word of the data file that is used by the block transfer read instruction in the next rung.

Instruction BT20:2.DN: This instruction will be true when the block transfer write has completed. The compare instruction that follows compares the first word of data sent from the scanner to the first word of data you send to the scanner. When the messaging function has completed, these two words will be equal.

Instruction BT20:3.EN: Any time the block transfer read is not enabled, this instruction causes the block transfer read to be enabled if the two earlier conditions are true.

BTR: Reads 64 words of data from the scanner.

The following table displays data sent to and received from the scanner. Values are in hexadecimal.

Offset	0	1	2	3	4	5	6	7	8	9
N30:0	201	6	E03	97	0	1	0	0	0	0
N30:10	0	0	0	0	0	0	0	0	0	0
N30:20	0	0	0	0	0	0	0	0	0	0
N30:30	0	0	0	0	0	0	0	0	0	0
N30:40	0	0	0	0	0	0	0	0	0	0
N30:50	0	0	0	0	0	0	0	0	0	0
N30:60	0	0	0	0	0	0	0	0	0	0
N30:70	201	6	8E03	4	0	0	0	0	0	0
N30:80	0	0	0	0	0	0	0	0	0	0
N30:90	0	0	0	0	0	0	0	0	0	0
N30:100	0	0	0	0	0	0	0	0	0	0
N30:110	0	0	0	0	0	0	0	0	0	0
N30:120	0	0	0	0	0	0	0	0	0	0
N30:130	0	0	0	0						

In this example, there were four entries in the fault queue. Notice the following about the data:

Location	Value	Meaning
N30:0	0x0201	TXID of 2. Command 1 (Execute)
N30:1	0x0006	Port 0. Size = 6 bytes (N30:3 – 5)
N30:2	0x0E03	Service E (Get Attribute Single) Node 3
N30:3	0x0097	SCANport Pass-Through Fault Object
N30:4	0x0000	Instance 0 (Class Access)
N30:5	0x0001	Attribute 1 (Number of Fault Queues)
N30:70	0x0201	TXID of 2. Status 1 (Success)
N30:71	0x0006	Port 0. Size = 6 bytes (N30:3 – 5)
N30:72	0x8E03	Service 8E (Get Attribute Single Response)
N30:73	0x0004	4 fault queues

Refer to Appendix C, *DeviceNet Objects*, for more information on object descriptions.

SLC Messaging

Figure 6.4 shows an example message in the SLC ladder logic program started in Chapter 5, *Creating a Ladder Logic Program*.

Figure 6.4
SLC Messaging Example

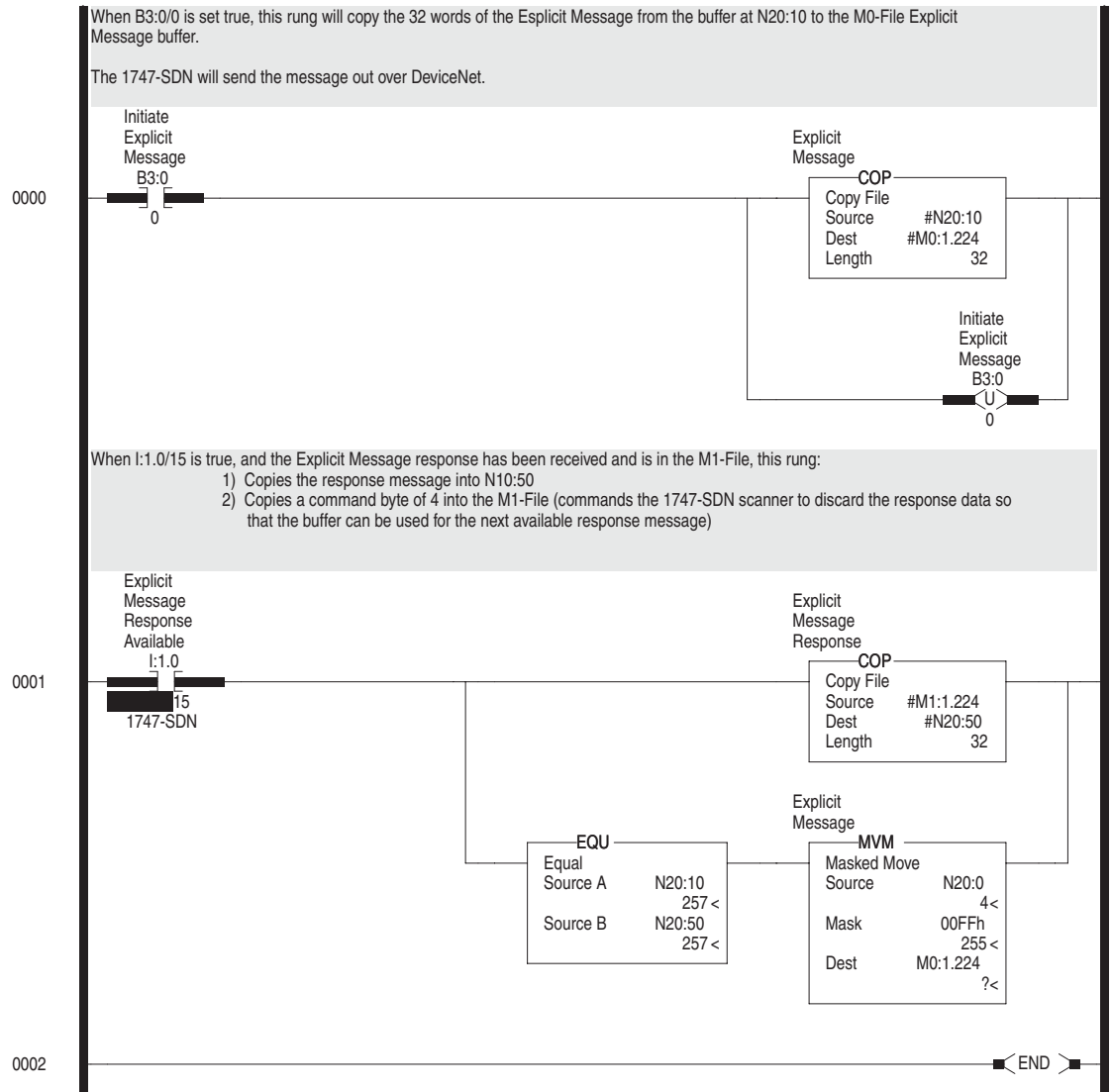

Important: To originate a scanner transaction, you must use a copy operation to M0:[slot number]:224. Then, use a copy operation to read M1:1.224 for the results. If you have more than one message enabled, you will have to use the TXID to determine which message you are reading.

The following table display data sent to and received from the scanner. Values are in hexadecimal.

Offset	0	1	2	3	4	5	6	7	8	9
N20:0	4	0	0	0	0	0	0	0	0	0
N20:10	201	6	E03	97	0	1	0	0	0	0
N20:20	0	0	0	0	0	0	0	0	0	0
N20:30	0	0	0	0	0	0	0	0	0	0
N20:40	0	0	0	0	0	0	0	0	0	0
N20:50	201	6	8E03	4	0	0	0	0	0	0
N20:60	0	0	0	0	0	0	0	0	0	0
N20:70	0	0	0	0	0	0	0	0	0	0
N20:80	0	0								

In this example, there were four entries in the fault queue. Notice the following about the data:

Location	Value	Meaning
N20:10	0x0201	TXID of 2. Command 1 (Execute)
N20:11	0x0006	Port 0. Size = 6 bytes (N20:13 – 15)
N20:12	0x0E03	Service E (Get Attribute Single) Node 3
N20:13	0x0097	SCANport Pass-Through Fault Object
N20:14	0x0000	Instance 0 (Class Access)
N20:15	0x0001	Attribute 1 (Number of Fault Queues)
N20:50	0x0201	TXID of 2. Status 1 (Success)
N20:51	0x0006	Port 0. Size = 6 bytes (N20:53 – 55)
N20:52	0x8E03	Service 8E (Get Attribute Single Response) Node 3
N20:53	0x0004	4 fault queues

Refer to Appendix C, *DeviceNet Objects*, for more information on object descriptions.

Using Messages to Control SCANport Products

Explicit messages provide multi-purpose, point-to-point communication paths between two devices. It is possible to control SCANport devices through explicit messaging on DeviceNet by following particular guidelines and by writing to various register objects that are buffering the I/O data. The write function is protected to ensure safe operation. The guidelines are as follows:

- The adapter cannot be allocated by a master/scanner in order to allow explicit writes to the register object.
- Write access to any register object within the adapter will not be allowed if the message is passed through a connection whose expected packet rate (EPR) is zero.
- The adapter is required to mark any explicit connection after allowing a write to a register object through it.
- If a marked explicit connection times out based on the EPR, then the I/O fault action will be that configured for Communication Loss over the I/O connection.
- If a marked explicit connection is deleted, then the I/O fault action will be that configured for Idle over the I/O connection.
- Multiple explicit connections can write/overwrite the control I/O if they meet the guidelines specified. Each connection will need to be marked individually within the adapter.
- If the adapter gets allocated/re-allocated by a controller such that valid I/O data is being sent to the adapter, or if an Idle condition from the allocating controller is transitioned back to valid data, then all marked explicit connections will be reset to unmarked and future writes blocked.
- If a marked connection has its EPR value reset to zero (0) after being marked, then the connection will become unmarked.

Writing to Register Objects

Within the DeviceNet adapter, various register objects buffer I/O in the following fashion (RO=Read Only, R/PW=Read/Protected Write):

Instance	Access	Size	Function
1	RO	See M-S Output	Poll Response I/O data to controller
2	R/PW	See M-S Output	Buffered Poll I/O data from controller
3	RO	32 bits	Logic Status & Feedback
4	R/PW	32 bits	Datalink A from SCANport Device (if enabled)
5	RO	32 bits	Datalink A to SCANport Device (if enabled)
6	R/PW	32 bits	Datalink A from SCANport Device (if enabled)
7	RO	32 bits	Datalink B to SCANport Device (if enabled)
8	R/PW	32 bits	Datalink B from SCANport Device (if enabled)
9	RO	32 bits	Datalink C to SCANport Device (if enabled)
10	R/PW	32 bits	Datalink C from SCANport Device (if enabled)
11	RO	32 bits	Datalink D to SCANport Device (if enabled)
12	R/PW	32 bits	Datalink D from SCANport Device (if enabled)
13	RO	32 bits	Logic Status and Feedback
14	R/PW	32 bits	Logic Command (Last Logic Command is ANDed with the first word in this command and ORed with the second word in the command. The reference is not modified. This command allows bit changes to the logic command without affecting the speed reference or other control bits.)

Refer to the “Class Code 0x07 — Register Object” section in Appendix C, *DeviceNet Objects* for more information on the Register Object.

Troubleshooting

Chapter Objectives

Chapter 7 provides information about the LEDs on the 1203-GK5 module and 1336-GM5 board. It also provides basic troubleshooting procedures. In this chapter, you will read about the following:

- Locating the LEDs.
- Using the LEDs to troubleshoot.

LEDs on the DeviceNet Adapter

Both the 1203-GK5 module and 1336-GM5 board have two LED status indicators. The LEDs provide status information about the DeviceNet network and SCANport connection. For the location of the LEDs, refer to Figure 7.1.

Figure 7.1
LED Status Indicators

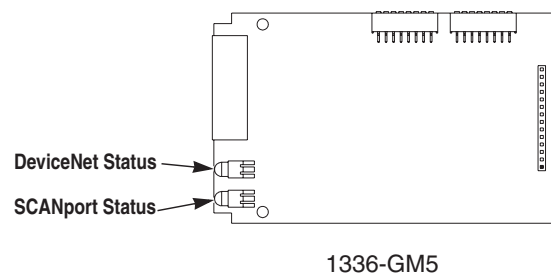
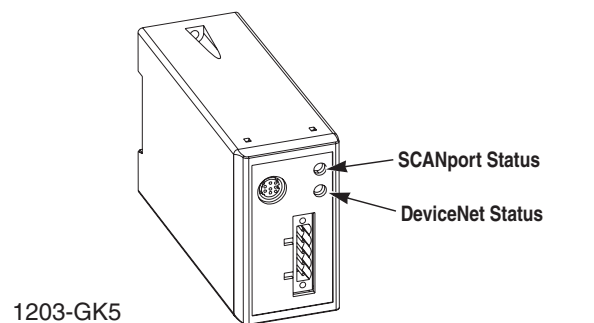

DeviceNet Network Status LED

The LED closest to the DeviceNet connector is the DeviceNet Status LED. It is labeled "NET." Refer to the following table:

LED status	State:	Indicates	Action:
off	Not powered/Not online	No power/Duplicate ID not completed	<ol style="list-style-type: none"> 1. Verify that the network power supply is connected and that power is reaching the adapter through the connector. 2. Verify that one or more nodes are communicating on the network. 3. Verify that at least one other node on the network is operational at the same time and data rate as the adapter.
flashing green	Online/Not connected	Passed duplicate ID/No connection established	No action needed. The LED is flashing to signify that there are no open communication connections between the adapter and any other device. Any connection (I/O or explicit message) made to the adapter over DeviceNet will cause the LED to stop flashing and remain steady on for the duration of any open connection.
steady green	Online/Connected	One or more connections established	No action needed.
flashing red	Online/Time-out	I/O connection timed out	<ol style="list-style-type: none"> 1. Connect the controller to the network. 2. Reduce traffic or errors on the network so that messages can get through within the necessary time frame.
steady red	Network failure	Failed Duplicate ID or Bus-off	<ol style="list-style-type: none"> 1. Verify that all nodes have unique addresses. 2. If all node addresses are unique, examine network for correct media installation.

SCANport Status LED States

The LED furthest from the DeviceNet connector is the SCANport Status LED. It is labeled “SP.” It indicates the status of the SCANport connection. Refer to the following table:

LED Status	State:	Indicates	Action:
off	Not powered	No power	<ol style="list-style-type: none"> 1. Verify that the connected SCANport product is powered. 2. Verify that SCANport cables are connected securely to the product. 3. Verify that the SCANport connection is operating correctly. (Test the connection with a HIM.)
flashing green	Online/ I/O connecting	Requesting I/O connections or no I/O is selected	No action needed. Adapter is establishing one or more of the I/O connections with the SCANport product.
steady green	I/O operational	One or more connections established	No action needed.
flashing red	Configuration fault	SCANport problem: No communications seen from the SCANport device to request connections	<ol style="list-style-type: none"> 1. Reseat cable properly. 2. Replace cable. 3. Verify that the SCANport connection is operating correctly. (Test the connection with a HIM.)
steady red	Link failure	SCANport failure: Poor cable connection does not allow proper port identification or the SCANport device isn't allowing the configured I/O connections.	<ol style="list-style-type: none"> 1. Verify that all SCANport cables are securely connected to the SCANport product. 2. Verify that datalinks are not enabled on a product that does not support datalinks. 3. Verify that a particular datalink is not already being used by another adapter on the same SCANport product. 4. After the problem is corrected, power cycle the adapter.
steady orange	Product failed SCANport compatibility test		Call Rockwell Automation support.

This Page Intentionally Left Blank.

Specifications

Appendix Objectives

Appendix A provides the specifications that you may need to install or use either the 1203-GK5 module or the 1336-GM5 board. These adapters are non-repairable units. If they are broken, you must replace the whole unit.

DeviceNet Conformance Tested

Both the 1203-GK5 module and 1336-GM5 board are DeviceNet Conformance Tested.

1203-GK5 Module Specifications

The following table gives the specifications for the 1203-GK5 DeviceNet communications module.

Category		Specifications
Electrical	Input Voltage	12 to 25 V DC
	Input Current	110 mA ^①
	SCANport Load	60 mA DC
Environmental	Operating Temperature	0 to +50°C (32 to 122°F)
	Storage Temperature	-40 to +85°C (-40 to 185°F)
	Relative Humidity	0 to 95% non-condensing
Communications	DeviceNet	
	Baud Rates	125, 250, 500 k BPS
	Distance Maximum	500 m (1640 ft.) @ 125 k BPS 200 m (820 ft.) @ 250 k BPS 100 m (328 ft.) @ 500 k BPS
Mechanical	Height	76 mm (3.0 in.)
	Width	45 mm (1.8 in.)
	Depth	123 mm (4.8 in.)
	Enclosure	NEMA Type 1 (IP30)
	DIN Rail Standard	35 mm x 7.5 mm (1.38 in. x 0.30 in.)

^① Inrush current may be four times the input current for 5 ms.

1336-GM5 Board Specifications

The following table gives the specifications for the 1336-GM5 DeviceNet communications board.

Category		Specifications
Electrical	Input Voltage Input Current (supplied via DeviceNet)	12 to 25 V DC 40 mA
Environmental	Operating Temperature Storage Temperature Relative Humidity	0 to +50°C (32 to 122°F) -40 to +85°C (-40 to 185°F) 0 to 95% non-condensing
Communications	DeviceNet Baud Rates Distance Maximum	125, 250, 500 k BPS 500 m (1640 ft.) @ 125 k BPS 200 m (820 ft.) @ 250 k BPS 100 m (328 ft.) @ 500 k BPS
Mechanical	Height Width Depth	71.1 mm (2.8 in.) 114.3 mm (4.5 in.) 12.7 mm (0.5 in.)
ESD Susceptibility	Contact Open Air	4 KV 8 KV



ATTENTION: The 1336-GM5 communications board contains ESD (Electrostatic Discharge) sensitive parts. Static control precautions are required when installing, testing, or servicing this assembly. Device malfunction may occur if you do not follow ESD control procedures. If you are not familiar with static control procedures, refer to Rockwell Automation Publication 8000-4.5.2, *Guarding Against Electrostatic Damage*, or other applicable ESD protection handbook.

Parameters in the 1203-GK5 Module and 1336-GM5 Board

Appendix Objectives

Appendix B provides information on the parameters in the 1203-GK5 module and 1336-GM5 board. In this appendix, you will read about the following:

- Factory-default settings.
- Parameters in the 1203-GK5 module and 1336-GM5 board.

Factory Default Settings

The factory-default settings of the 1203-GK5 module and 1336-GM5 board include the following:

- 16-bit Logic Command/Status enabled for polling.
- 16-bit Reference/Feedback enabled for polling.
- If the scanner is put into program mode or the network faults, the SCANport product is faulted.
- A node address of 63.
- DeviceNet data rate of 125 KBPS.

If you intend to change any of these settings, refer to Chapter 2, *Parameters in the 1203-GK5 Module and 1336-GM5 Board*, for detailed instructions.

Parameters

The following table provides information on the parameters in the 1203-GK5 module and 1336-GM5 board.

Important: When accessing this parameter set through the DeviceNet Parameter Class, add the adapter parameter number to the number of the last parameter of the SCANport device. When accessing this parameter set through the vendor-specific SCANport Variables-Linear Class, add the adapter parameter number to 0x4000.

1 DN-SW1 Setup

Displays the switches settings on SW1.

Important: The present settings may not be the condition under which the module is operating. They will be the values that are read after a SCANport/DeviceNet power cycle.

Refer to Chapter 2, *Configuring the 1203-GK5 Module or 1336-GM5 Board*, for more information.

Parameter Number	1
Parameter Type	Read Only
Factory Default	0000 0000
Power Cycle Required	No

Bit 8	Bit 7	Bit 6	Bit 5	Bit 4	Bit 3	Bit 2	Bit 1	
								Datalink A Enabled
								Datalink B Enabled
								Datalink C Enabled
								Datalink D Enabled
								Not Used
								Hold Last State/Zero Data
								Disable Comm Loss Fault
								Disable Pgm/Idle Fault

2 DN-SW2 Node Adx

Displays the node address as it is set on SW2, switches 1 through 6.

Important: This setting is not the setting used by the adapter if either of the following conditions is true:

- The switches were reset and the adapter was not power cycled.
- Switches 7 and 8 on SW2 are both set to on, so the adapter reads the node address from parameter 4.

Refer to Chapter 2, *Configuring the 1203-GK5 Module or 1336-GM5 Board*, for more information.

Parameter Number	2
Parameter Type	Read Only
Factory Default	63
Minimum Value	0
Maximum Value	63
Power Cycle Required	No

3 DN-SW2 Data Rate

Displays the Data Rate as it is set on SW2, switches 7 and 8.

Important: This setting is not the setting used by the adapter if either of the following conditions is true:

- The switch was reset and the adapter was not power cycled.
- Switches 7 and 8 on SW2 are both set to on, so the adapter reads the data rate from parameter 5.

Refer to Chapter 2, *Configuring the 1203-GK5 Module or 1336-GM5 Board*, for more information.

Parameter Number	3
Parameter Type	Read Only
Factory Default	125 kbps
Minimum Value	0
Maximum Value	3
Units	0 = 125 1 = 250 2 = 500 3 = Program using network ^①
Power Cycle Required	No

^① When set to this position, the data rate and node address are programmed over the DeviceNet network using DeviceNet Manager software.

4 DN-NV-Node Adx

Lets the user program the node address using software such as DeviceNet Manager. To use this feature, SW2 switches 7 and 8 must be set ON during the network power-up of the adapter. Changing this parameter does not change the actual node address until the next network power cycle.

Important: The DeviceNet Manager software allows immediate node address changes through Node Address configuration windows.

Refer to Chapter 4, *Configuring a Scanner to Communicate with the 1203-GK5 Module or 1336-GM5 Board*, for more information.

Parameter Number	4
Parameter Type	Read/Write
Factory Default	63
Minimum Value	0
Maximum Value	63
Power Cycle Required	Yes

5 DN-NV-Data Rate

Lets the user set the DeviceNet data rate using software such as DeviceNet Manager. To use this feature, SW2 switches 7 and 8 must be set ON during the network power-up of the adapter. Changing this parameter does not change the actual data rate until the next network power cycle.



ATTENTION: Do not use the DeviceNet Manager software to change the Data Rate unless the module is connected in a point-to-point fashion. Attempting to do otherwise will cause the entire network to go down.

Refer to Chapter 4, *Configuring a Scanner to Communicate with the 1203-GK5 Module or 1336-GM5 Board*, for more information.

Parameter Number	5
Parameter Type	Read/Write
Factory Default	125 kbps
Minimum Value	0
Maximum Value	2
Units	0 = 125 1 = 250 2 = 500
Power Cycle Required	Yes

6 SCANport Adapter

Displays the SCANport port used by the adapter. A value of seven indicates that the SCANport product is not connected to the adapter or is not powered.

Parameter Number	6
Parameter Type	Read Only
Factory Default	7
Minimum Value	0
Maximum Value	7
Units	0 = Product not connected or not powered 1 = Adapter 1 2 = Adapter 2 3 = Adapter 3 4 = Adapter 4 5 = Adapter 5 6 = Adapter 6 7 = Product not connected or not powered.
Power Cycle Required	No

This Page Intentionally Left Blank.

DeviceNet Objects

Appendix Objectives

Appendix C defines the DeviceNet object classes, class services, and attributes that are supported by the DeviceNet adapter. These objects can be used to develop programs for the module.

This appendix assumes that you have experience in object programming.

Object Classes

The DeviceNet adapter supports the following object classes:

Class	Object	Page
0x01	Identity	C-2
0x02	Message Router	C-4
0x03	DeviceNet	C-5
0x05	Connection	C-6
0x07	Register	C-8
0x0F	Parameter	C-10
0x10	Parameter Group	C-16
0x67	PCCC Object	C-18
0x93	SCANport Pass-Through Parameter	C-20
0x97	SCANport Pass-Through Fault Queue	C-21
0x98	SCANport Pass-Through Warning Queue	C-23
0x99	SCANport Pass-Through Link	C-25

Class Code 0x01 — Identity Object

The identity object provides identification and general information about the device.

Class Attributes

Attribute ID	Access Rule	Name	Data Type	Description
2	Get	Max Instance	UINT	Maximum instance number of an object currently created in this class level of the device.

Instances

The total number of instances depends on the number of microprocessors in the SCANport product connected to the module.

- Instance 1 includes information on both the adapter and the product.
- The instances for the SCANport product's microprocessors start at instance 2.
- The instance for the adapter is present after all the instances for the SCANport product's microprocessors.

Instance	Description
1	Total Product
2 through n - 1 ^①	Product components
n ^①	DeviceNet Adapter

^① The value of n is the maximum instance in the object. This value is obtainable via class attribute 2.

Instance Attributes

Attribute ID	Access Rule	Name	Data Type	Description
1	Get	Vendor ID	UINT	Identification of each vendor by number. 1 = Allen-Bradley
2	Get	Device Type	UINT	Indication of general type of product. 0x69 = Sub-Component 0x65 = SCANport Device
3	Get	Product Code	UINT	Identification of a particular Allen-Bradley product. 0xXX02 = 1336 PLUS 0.5 – 10 HP 0xXX03 = 1336 PLUS 7.5 – 800 HP 0xXX07 = 1336 PLUS II 0xXX10 = 1336 FORCE w/ PLC Adapter 0xXX11 = 2364F RGU 0xXX12 = 1394 Motion Drive 0xXX13 = 1557 Medium Voltage AC Drive 0xXX14 = 193 SMP-3 0xXX15 = 150 SMC Dialog Plus 0xXX17 = 1305 AC Drive 0xXX18 = 1397 DC Drive 0xXX19 = 1336 REGEN 0xXX20 = 1336 FORCE with Std Adapter 0xXX22 = 1336 IMPACT Important: The high byte of each code indicates a particular size or configuration within a product family.
4	Get	Revision	STRUCT of	Revision of the item that this instance of the Identity Object represents. Value varies based on product.
		Major Revision	USINT	
		Minor Revision	USINT	
5	Get	Status	WORD	Summary status of product. Value varies based on product.
6	Get	Serial Number	UDINT	Serial number of product. Value varies based on product.
7	Get	Product Name	SHORT_STRING	Human readable identification. Value varies based on product.

Common Services

Service Code	Implemented for:		Service Name
	Class	Instance	
0x05	Yes	No	Reset
0x0E	Yes	Yes	Get_Attribute_Single
0x10	No	No	Set_Attribute_Single
0x11	Yes	N/A	Find_Next_Obj_Instance

Get_Attribute_All Response

None supported.

Class Code 0x02 — Message Router Object

The Message Router Object provides a messaging connection point through which a client may address to any object class or instance residing in the physical devices.

Class Attributes

Not supported.

Instances

Instance	Description
1	Message Router Object

Instance Attributes

Attribute ID	Access Rule	Name	Data Type	Description
2	Get	Number available	UINT	Maximum number of connections supported by the message router.
3	Get	Number active	UINT	Number of connections currently used by system components.
4	Get	Active connections	ARRAY of UINT	A list of the connection IDs of the currently active connections. This attribute not used. Reserved for compatibility purposes.

Common Services

Service Code	Implemented for:		Service Name
	Class	Instance	
0x0E	Yes	Yes	Get_Attribute_Single

Class Code 0x03 — DeviceNet Object

The DeviceNet Object is used to provide the configuration and status of a physical attachment to DeviceNet. A product must support one (and only one) DeviceNet Object per physical network attachment.

Class Attributes

Attribute ID	Access Rule	Name	Data Type	Description
1	Get	DeviceNet Specification	Word	Returns 2

Instances

Not supported.

Instance Attributes

Attribute ID	Access Rule	Name	Data Type	Description
1	Get	Mac ID	USINT	Node Address
2	Get	Data Rate	USINT	Data Rate
3	Get	BOI	BOOL	Default = 0
4	Set	Bus Off Counter	USINT	Increments if BOI is non-zero and Bus Off occurs. Can only be set to zero.
5	Get	Allocation Information	STRUCT of BYTE USINT	The allocation information a slave supports when the master allocates.
6	Get	Node Adx Switch Err	BOOL	If non-zero, the Node Address NVS value does not match the online value.
7	Get	Data Rate Switch Err	BOOL	If non-zero, the Data Rate NVS value does not match the online value.
8	Get	Node Adx Switch	USINT	The actual value in the EEPROM
9	Get	Data Rate Switch Val	USINT	The actual value in the EEPROM or the operating value after an autobaud was completed.

Common Services

Not supported.

Class Code 0x05 — Connection

The Connection Class allocates and manages the internal resources associated with both I/O and Explicit Messaging Connections. The specific instance generated by the Connection Class is referred to as a *Connection Instance* or a *Connection Object*.

Important: An externally visible interface to the Connection Class across Explicit Messaging Connections **DOES** exist. Unless otherwise noted, all services/attributes noted in the following sections are accessible using Explicit Messaging.

A Connection Object within a particular module actually represents one of the end-points of a Connection. It is possible for one of the Connection end-points to be configured and “active” (e.g., transmitting) without the other end-point(s) being present. Connection Objects are used to model the communication specific characteristics of a particular Application-to-Applications(s) relationship. A specific Connection Object Instance manages the communication-specific aspects related to an end-point.

A Connection Object on DeviceNet uses the services provided by a Link Producer and/or Link Consumer to perform low-level data transmission and reception functions.

Class Attributes

Attribute ID	Access Rule	Name	Data Type	Description
1	Get	Revision	UINT	Revision of the Connection Object class definition upon which the implementation is based Range 1 – 65535

Instances

Instance	Description
1	Group 2 Messaging
2	Group 2 Polling
6	Group 3 Messaging
7	Group 3 Messaging
8	Group 3 Messaging
9	Group 3 Messaging
10	Group 3 Messaging

Instance Attributes

Attribute ID	Access Rule	Name	Data Type	Description
1	Get	State	USINT	State of the connection as defined in the DeviceNet specification
2	Get	Instance type	USINT	Indicates I/O or Messaging connection
3	Get	Transport Class Trigger	USINT	The Transport Class Trigger for this instance
4	Get	Produced Cnxn ID	USINT	CAN Identifier to transmit on
5	Get	Consumed Cnxn ID	USINT	CAN Identifier to receive on
6	Get	Initial Comm Char	USINT	Defines the DeviceNet message groups that the tx/rx Cnxn's apply
7	Get	Produced Cnxn Size	UINT	Max bytes to transmit across this connection
8	Get	Consumed Cnxn Size	UINT	Max bytes to receive across this connection
9	Get/Set	EPR	UINT	Expected Packet Rate
12	Get/Set	Watchdog Action	USINT	How to handle inactivity/watchdog time-outs
13	Get	Produced Path Length	UINT	Number of bytes in the produced connection path attribute
14	Get	Produced Cnxn Path	ARRAY of USINT	Specifies the application object whose data is to be produced by this connection
15	Get	Consumed Path Length	UINT	Number of bytes in the consumed connection path attribute
16	Get	Consumed Cnxn Path	ARRAY of USINT	Specifies the application object to receive the data consumed by this application

Common Services

Not supported.

Class Code 0x07 — Register Object

The Register Object is used to address individual bits or a range of bits. It may operate as either a producer (input) register or a consumer (output) register. A producer register object produces data onto the network. A consumer register object consumes data from the network.

Message writes to the Register Object can perform control functions. Therefore, message writes are only allowed when the controller is not actively controlling the module and the message write is done through a connection with a time-out value not equal to zero. Writes cannot be performed through an unconnected message. After a write, any time-out or closure of the connection may cause the SCANport product to fault.

Refer to Chapter 6, *Using DeviceNet Explicit Messages*, for information about writing to the Register Object.

Class Attributes

Not supported.

Instances

Instance	Description
1	All polled data being read from the SCANport device (read-only)
2	All polled data written to the SCANport device (read/write)
3	Logic Status and Feedback data (read-only)
4	Logic Command and Reference data (read/write)
5	Datalink A input data (read-only)
6	Datalink A output data (read/write)
7	Datalink B input data (read-only)
8	Datalink B output data (read/write)
9	Datalink C input data (read-only)
10	Datalink C output data (read/write)
11	Datalink D input data (read-only)
12	Datalink D output data (read/write)
13	Logic Status and Feedback Data (read-only)
14	Logic Command and Reference Data ^① (read/write)

① The command word is set to the value of the first word of the data where there are ones in the second word of the data. Command = (word 1 and not word 2) or (word 1 and word 2). This only controls specified bits in the logic command data to the SCANport product and does not change the reference value.

Instance Attributes

Setting of an assembly attribute can only be accomplished through a connection. This feature is to prevent accidental control of the SCANport product.

Attribute ID	Access Rule	Name	Data Type	Description
1	Get	Bad Flag	BOOL	If set to 1, then attribute 4 may contain invalid, bad or otherwise corrupt data. 0 = good 1 = bad
2	Get	Direction	BOOL	Direction of data transfer 0 = Producer Register 1 = Consumer Register
3	Get	Size	UINT	Size of register data in bits
4	Conditional ^①	Data	ARRAY of BITS	Data to be transferred

^① The access rule of Set is optional if attribute 2, Direction = 1. If Direction = 0, the access rule is Get.

Common Services

Service Code	Implemented for:		Service Name
	Class	Instance	
0x0E	Yes	Yes	Get_Attribute_Single
0x10	No	Yes	Set_Attribute_Single

Class Code 0x0F — Parameter Object

The Parameter Object provides a known, public interface for device configuration data. This object also provides all the information necessary to define and describe each individual configuration parameter of a device.

Class Attributes

Attribute ID	Access Rule	Name	Data Type	Description
1	Get	Revision	UINT	Revision of this object. First revision, value = 1.
2	Get	Max Instance	UINT	Maximum instance number of an object currently created in this class level of the device.
8	Get	Parameter Class Descriptor	WORD	Bits that describe parameters.
9	Get	Configuration Assembly Instance	UINT	Instance number of the configuration assembly. This attribute is set to zero because a configuration assembly is not supported.
10	Set	Native Language	USINT	Language ID for all character array accesses. 0 = English 1 = French 2 = Spanish 3 = Italian 4 = German 5 = Japanese 6 = Portuguese

Instances

The number of instances varies based on the number of parameters in your SCANport product. The adapter parameters immediately follow the SCANport product parameters.

Instance	Description
1 through $n - 41$ ^①	SCANport Product Parameters
$n - 41$ through n ^①	Module Parameters

^① The value of n is the maximum instance in the object. This value is obtainable via class attribute 2.

Instance Attributes

Attribute ID	Access Rule	Stub/Full	Name	Data Type	Description
1	①	Stub	Parameter Value	Specified in Descriptor, Data Type and Data Size attributes.	Actual value of parameter. Data type specified in descriptor, data type, and data size. ①②
2	Get	Stub	Link Path Size	USINT	Size of Link Path attribute. If this attribute is 0, then no link is specified. Number of BYTES in attribute 3.
3	Get	Stub	Link Path	ARRAY of path segments	Path to the object from where this parameter value is retrieved. The link path is limited to 255 BYTES.
			Segment type/port	BYTE	
			Segment Address	Path (format depends on data contained in segment type/port)	
4	Get	Stub	Descriptor	WORD	Descriptor of parameter. Refer to the table on page C-12.
5	Get	Stub	Data Type	USINT	Data type code. Refer to the table on page C-13.
6	Get	Stub	Data Size	USINT	Number of BYTES in attribute 1, Parameter Value.
7	Get	Full	Parameter Name String	SHORT_STRING	A text string representing the parameter name. For example, "frequency #1." The maximum number of characters is 16. (The first byte is a length code.)
8	Get	Full	Units String	SHORT_STRING	Engineering unit string. The maximum number of characters is 4. (The first byte is a length code.)
9	Get	Full		SHORT_STRING	The maximum number of characters is 64. (The first byte is a length code.) Always returns 0.
10	Get	Full	Minimum Value	Same as attribute 1	The minimum valid actual value to which attribute 1, Parameter Value can be set.
11	Get	Full	Maximum Value	Same as attribute 1	The maximum valid actual value to which attribute 1, Parameter Value can be set.
12	Get	Full	Default Value	Same as attribute 1	The actual value attribute 1, Parameter Value should be set to when the user wants the default for the parameter.
13	Get	Full	Scaling Multiplier	UINT	Multiplier for scaling formula.
14	Get	Full	Scaling Divisor	UINT	Divisor for scaling formula.
15	Get	Full	Scaling Base	UINT	Base for scaling formula.

① The access rule is defined in bit 4 of instance attribute 4, the Descriptor. If bit 4 is 0 the access rule is Set and the Parameter Value can be read and written. If bit 4 is 1, the access rule is Get and the Parameter Value can only be read.

② Data type specified in instance attributes 4 (Descriptor), 5 (Data Type) and 6 (Data Size).

Attribute ID	Access Rule	Stub/Full	Name	Data Type	Description
16	Get	Full	Scaling Offset	UINT	Offset for scaling formula.
17	Get	Full	Multiplier Link	UINT	Parameter object instance number of multiplier source.
18	Get	Full	Divisor Link	UINT	Parameter object instance number of base source.
19	Get	Full	Base Link	UINT	Parameter object instance number of offset source.
20	Get	Full	Offset Link	UINT	Parameter object instance number of offset source.
21	Get	Full	Decimal Precision	USINT	Specifies number of decimal places to use when displaying the scaled engineering value. Also used to determine actual increment value so that incrementing a value causes a change in scaled engineering value to this precision.

- ① The access rule is defined in bit 4 of instance attribute 4, the Descriptor. If bit 4 is 0 the access rule is Set and the Parameter Value can be read and written. If bit 4 is 1, the access rule is Get and the Parameter Value can only be read.
- ② Data type specified in instance attributes 4 (Descriptor), 5 (Data Type) and 6 (Data Size).

Bit Definitions for Instance Attribute 4

Bit	Definition	Value
0	Supports settable path	0 = Link path can not be set. 1 = Link path can be set.
1	Supports enumerated strings	0 = Enumerated strings are not supported. 1 = Enumerated strings are supported and may be read with the Get_Enum_String service.
2	Supports scaling	0 = Scaling not supported. 1 = Scaling is supported. The scaling attributes are implemented and the value presented is in engineering units.
3	Supports scaling links	0 = Scaling links not supported. 1 = The values for the scaling attributes may be retrieved from other parameter object instances.
4	Read only parameter	0 = Parameter value attribute can be written (set) and read (get). Access rule is set. 1 = Parameter value attribute can only be read. Access rule is get.
5	Monitor parameter	0 = Parameter value attribute is not updated in real time by the device. 1 = Parameter value attribute is updated in real time by the device.
6	Supports extended precision scaling	0 = Extended precision scaling is not supported. 1 = Extended precision scaling should be implemented and the value presented to the user in engineering units.

Data Types for Instance Attribute 5

Attribute ID Value	Definition	Data Type Description	Scaling Supported on this Data Type
1	WORD	16-bit word	No
2	UINT	16-bit unsigned integer	Yes
3	INT	16-bit signed integer	Yes
4	BOOL	Boolean	No
5	SINT	Short integer	Yes
6	DINT	Double integer	Yes
7	LINT	Long integer	Yes
8	USINT	Unsigned short integer	Yes

Common Services

Service Code	Implemented for:		Service Name
	Class	Instance	
0x01	No	Yes	Get_Attribute_All
0x0E	Yes	Yes	Get_Attribute_Single
0x10	No	Yes	Set_Attribute_Single
0x4B	No	Yes	Get_Enum_String
0x05	Yes	No	Reset_Request (sets all parameters to default values)
0x15	Yes	No	Restore_Request
0x16	Yes	No	Save_Request

Get_Attribute_All Response

Not supported.

At the instance level, the order of attributes returned in the Get_Attributes_All response is as follows:

Class Attribute ID	Attribute Name and Default Value
1	Parameter Value
2	Link Path Size
3	Link Path
4	Descriptor
5	Data Type
6	Data Size
7	Parameter Name String, default character count = 0
8	Units String, default character count = 0
9	Help String, default character count = 0
10	Minimum Value default = 0
11	Maximum Value default = 0
12	Default Value default = 0
13	Scaling Multiplier Default = 1
14	Scaling Divisor Default = 1
15	Scaling Base Default = 1
16	Scaling Offset Default = 0
17	Multiplier Link Default = 0
18	Divisor Link Default = 0
19	Base Link Default = 0
20	Offset Link Default = 0
21	Decimal Precision Default = 0

Object Specific Services

Service Code	Implemented for:		Service Name
	Class	Instance	
0x4B	No	Yes	Get_Enum_String

Enumerated strings are human-readable strings that describe either a bit or a value depending on the data type of instance attribute 1, the Parameter Value. If the data type is a BYTE or WORD, the enumerated string is a bit enumerated string. If the data type is INT or UINT, the enumerated string is a value enumerated string. Any other data type does not have enumerated strings.

The table below lists the parameters for the Get_Enum_String request service.

Name	Data Type	Description of Attribute
Enumerated String Number	USINT	Number of enumerated string to retrieve (MAX value is 255).

- If the string to be returned is a bit enumerated string, then the enumerated string number represents a bit position and the Get_Enum_String service returns a string from that bit.
- If the string to be returned is a value enumerated string, then the enumerated string number represents a value and the Get_Enum_String service returns a string for that value.

The enumerated string is returned in the form of a SHORT_STRING and is 16 characters long plus the preceding length byte.

Class Code 0x10 — Parameter Group Object

The Parameter Group Object identifies and provides access to groups of parameters in a device grouping. The Parameter Group Object provides convenient access to related sets of parameters.

Class Attributes

Attribute ID	Access Rule	Name	Data Type	Description
1	Get	Parameter group version	UINT	Returns 1
2	Get	Max Instance	UINT	Maximum instance number of an object currently created in this class level of the device.
8	Get	Native Language	USINT	Language ID for all STRING accesses. 0 = English 1 = French 2 = Spanish (Mexican) 3 = Italian 4 = German 5 = Japanese 6 = Portuguese

Instances

The number of instances varies based on the number of groups in the SCANport product. One additional group is added for the module.

Instance	Description
1 – (n - 1)	SCANport product groups
n ^①	Module group

① n is the value returned by a get from class attribute 2 (max instance).

Instance Attributes

Attribute ID	Access Rule	Name	Data Type	Description
1	Get	Group Name String	SHORT_STRING	A text string representing the group name (e.g., set-up, frequency set). Maximum number of characters = 16
2	Get	Number of Members in Group	UINT	Number of parameters in group.
3	Get	1st Parameter Number in Group	UINT	Parameter instance number.
4	Get	2nd Parameter Number in Group	UINT	Parameter instance number.
n	Get	(n-2)th Parameter Number in Group	UINT	Parameter instance number.

Common Services

Service Code	Implemented for:		Service Name
	Class	Instance	
0x0E	Yes	Yes	Get_Attribute_Single

Get_Attribute_All Response

Not supported.

Class Code 0x67 — PCCC Object

The PCCC Object is used to process encapsulated PCCC messages from DeviceNet. The PCCC Object does not implement any specific class or instance attributes, so the instance field for any received messages is ignored. Firmware version 2.001 or later supports this object.

Class Attributes

Not supported.

Instance Attributes

Not supported.

Common Services

Not supported.

Object Specific Services

Service Code	Implemented for:		Service Name
	Class	Instance	
0x4B	No	Yes	Execute_PCCC
0x4D	No	Yes	Execute_Local_PCCC

Message Structure for Execute_PCCC

Request			Response		
Name	Data Type	Description	Name	Data Type	Description
Length	USINT	Length of requestor ID	Length	USINT	Length of requestor ID
Vendor	UINT	Vendor number of requestor	Vendor	UINT	Vendor number of requestor
Serial Number	UDINT	ASA serial number of requestor	Serial Number	UDINT	ASA serial number of requestor
Other	Product Specific	Identifier of user, task, etc. on the requestor	Other	Product Specific	Identifier of user, task, etc. on the requestor
CMD	USINT	Command byte	CMD	USINT	Command byte
STS	USINT	0	STS	USINT	Status byte
TNSW	UINT	Transport word	TNSW	UINT	Transport word. Same value as the request.
FNC	USINT	Function code. Not used for all CMD's.	EXT_STS	USINT	Extended status. Not used for all CMD's.
PCCC_params	ARRAY of USINT	CMD/FNC specific parameters	PCCC_results	ARRAY of USINT	CMD/FNC specific result data

Message Structure for Execute_Local_PCCC

Request			Response		
Name	Data Type	Description	Name	Data Type	Description
CMD	USINT	Command byte	CMD	USINT	Command byte
STS	USINT	0	STS	USINT	Status byte
TNSW	UINT	Transport word	TNSW	UINT	Transport word. Same value as the request.
FNC	USINT	Function code. Not used for all CMD's.	EXT_STS	USINT	Extended status. Not used for all CMD's.
PCCC_params	ARRAY of USINT	CMD/FNC specific parameters	PCCC_results	ARRAY of USINT	CMD/FNC specific result data

More Information

For more information on PCCC messages, refer to Appendix D, *Supported PCCC Messages*

Class Code 0x93 — SCANport Pass-Through Parameter Object

The SCANport Pass-Through Parameter Object lets you perform a scattered read or write.

Class Attributes

Not supported.

Instance Attributes

Not supported.

Common Services

Not supported.

Object-Specific Services

Service Code	Implemented for:		Service Name
	Class	Instance	
0x32	Yes	No	Scattered_Parameter_Value_Read ^①
0x34	Yes	No	Scattered_Parameter_Value_Write ^①

^① Must be directed to Attribute 0, Instance 0.

The table below lists the parameters for the Scattered_Parameter_Value_Read and Scattered_Parameter_Value_Write object-specific services:

Name	Data Type	Description
Scattered Parameters	STRUCT of	
Parameter Number	WORD	Parameter to read or write
Parameter Value	WORD	Parameter value to write (zero when reading)

Important: The STRUCT may repeat up to 32 times in a single message.

Class Code 0x97 — SCANport Pass-Through Fault Object

The SCANport Pass-Through Fault Object provides information on the product's fault queue.

Class Attributes

Attribute ID	Access Rule	Name	Data Type	Description
0	Set	Write Fault Command	BYTE	1 = Clear Faults 2 = Clear Fault Queue 3 = Reset Product
1	Get	Read Number of Fault Queue Entries	BYTE	Reads the number of fault queue entries.
2	Get	Read Fault Queue Trip Index	BYTE	Reads the index of the fault that tripped the product.

Instance Attributes

Attribute ID	Access Rule	Name	Data Type	Description
0	Get	Read Fault Queue Entry Full/All Info	STRUCT of	
		Fault Text	ARRAY of BYTE	16 character string (no length information, no terminating null).
		Fault Code	WORD	Fault Code.
		Fault Time Stamp	STRUCT	
			BYTE	1/100 Second (0 – 99).
			BYTE	Second (0 – 59).
			BYTE	Minute (0 – 59).
			BYTE	Hour (0 – 23).
			BYTE	Day of Week (0 – 6). ^①
			BYTE	Date (1 – 31).
			BYTE	Month (1 – 12).
	BYTE	Year (0 – 99 ^②).		
128	Get	Fault Code and Time Stamp	STRUCT of	
		Fault Code	WORD	Fault Code.
		Fault Time Stamp	STRUCT of	
			BYTE	1/100 Second (0 – 99).
			BYTE	Second (0 – 59).
			BYTE	Minute (0 – 59).
			BYTE	Hour (0 – 23).
			BYTE	Day of Week (0 – 6). ^①
			BYTE	Date (1 – 31).
			BYTE	Month (1 – 12).
	BYTE	Year (0 – 99 ^②).		
129	Get	Read Fault Text String Only	ARRAY of BYTE	16 character string (no length information, no terminating null).

^① Sunday is a value of zero.

^② Year is an offset from 1990.

Common Services

Service Code	Implemented for:		Service Name
	Class	Instance	
0x0E	Yes	Yes	Get_Attribute_Single
0x01	Yes	Yes	Set_Attribute_Single

Class Code 0x98 — SCANport Pass-Through Warning Object

The SCANport Pass-Through Warning Object provides information on the product's warning queue.

Class Attributes

Attribute ID	Access Rule	Name	Data Type	Description
0	Set	Write Warning Command	BYTE	Write Warning Command. 1 = Clear Warnings 2 = Clear Warning Queue 3 = Reset Product
1	Set	Read Number of Warning Queue Entries	BYTE	

Instance Attributes

Attribute ID	Access Rule	Name	Data Type	Description
0	Get	Read Warning Queue Entry Full/All Info	STRUCT of	
		Warning Text	ARRAY of BYTE	16 character string (no length information, no terminating null).
		Warning Code	WORD	Fault Code.
		Warning Time Stamp (Time Stamps not available in all products)	STRUCT	
			BYTE	1/100 Second (0 – 99).
			BYTE	Second (0 – 59).
			BYTE	Minute (0 – 59).
			BYTE	Hour (0 – 23).
			BYTE	Day of Week (0 – 6). ^①
			BYTE	Date (1 – 31).
	BYTE	Month (1 – 12).		
	BYTE	Year (0 – 99 ^②).		

① Sunday is a value of zero.

② Year is an offset from 1990.

Attribute ID	Access Rule	Name	Data Type	Description
128	Get	Warning Code and Time Stamp (Time Stamps not available in all products)	STRUCT of	
		Warning Code	WORD	Fault Code.
		Warning Time Stamp (Time Stamps not available in all products)	STRUCT of	
			BYTE	1/100 Second (0 – 99).
			BYTE	Second (0 – 59).
			BYTE	Minute (0 – 59).
			BYTE	Hour (0 – 23).
			BYTE	Day of Week (0 – 6). ^①
			BYTE	Date (1 – 31).
			BYTE	Year (0 – 99 ^②).
129	Get	Read Warning Text String Only	ARRAY of BYTE	16 character string (no length information, no terminating null).

① Sunday is a value of zero.

② Year is an offset from 1990.

Common Services

Service Code	Implemented for:		Service Name
	Class	Instance	
0x0E	Yes	Yes	Get_Attribute_Single
0x01	Yes	Yes	Set_Attribute_Single

Class Code 0x99 — SCANport Pass-Through Link Object

The SCANport Pass-Through Link Object lets you perform a scattered read or write of a number of links or a single read or write of a link.

Class Attributes

Attribute ID	Access Rule	Name	Data Type	Description
0	Set	Link Command	BYTE	1 = Clear all links.
1	Get	NVS Link Diagnostic Value	WORD	Checksum.

Instance Attributes

Attribute ID	Access Rule	Name	Data Type	Description
0	Set	Parameter Link Reference ^②	WORD	

Important: An instance in this class is the number of a parameter that is to get its value from another parameter.

^② The Parameter Link Reference value is the number of the parameter whose value is to be transferred.

Common Services

Service Code	Implemented for:		Service Name
	Class	Instance	
0x0E	Yes	Yes	Get_Attribute_Single
0x01	Yes	Yes	Set_Attribute_Single

Object-Specific Services

Service Code	Implemented for:		Service Name
	Class	Instance	
0x32	Yes	No	Scattered_Link_Reference_Value_Read ^①
0x34	Yes	No	Scattered_Link_Reference_Value_Write ^①

^① Must be directed to Attribute 0, Instance 0.

The table below lists parameters for Scattered_Link_Reference_Read and Scattered_Link_Reference_Write object-specific services.

Name	Data Type	Description
Scattered Link Read/Write	STRUCT of	
Parameter Number	WORD	Parameter Link Reference to read or write.
Parameter Link Reference	WORD	Link Reference value to write (zero when reading).

Important: The STRUCT may repeat up to 32 times in a single message.

Supported PCCC Messages

Appendix Objectives

Appendix D describes the PCCC object. This object provides a mechanism for PLC products to utilize native messages across DeviceNet. The 1203-GK5 module (firmware v2.001 or later) and 1336-GM5 board (firmware v2.001 or later) support the PCCC object in order to support communications with PLCs and software programs such as DriveExplorer that support PCCC messages. In this appendix, you will read about the following:

- PCCC support.
- A list of supported PCCC messages.

PCCC Support

The 1203-GK5 module and 1336-GM5 board translate PCCC messages into SCANport messages. To communicate using PCCC with the SCANport product, you need a computer running software such as DriveExplorer that can communicate and translate the PCCC messages supported by the module and a DeviceNet interface that will transport PCCC messages over DeviceNet. Other products that support PCCC objects include the 1203-GU6, 1336-GM6, and 1761-NET-DNI.

Supported PCCC Messages

The 1203-GK5 and 1336-GM5 support the following PCCC messages:

CMD	FNC	Message Definition	Supported?
0x06	0x03	Identify Host and Some Status	Yes
0x0F	0x67	PLC-5 Typed Write	Yes
0x0F	0x68	PLC-5 Typed Read	Yes
		Logical ASCII Address	Yes
		Logical Binary Address	No
		PLC-2 System Address	No
		PLC-3 Symbolic Address	No
0x0F	0xA1	SLC-500 Protected Typed Logical Read w/ 2 Address Fields — File, Element	No
0x0F	0xA2	SLC-500 Protected Typed Logical Read w/ 3 Address Fields — File, Element, Sub-Element	Yes
0x0F	0xA9	SLC-500 Protected Typed Logical Write w/ 2 Address Fields — File, Element	No
0x0F	0xAA	SLC-500 Protected Typed Logical Write w/ 3 Address Fields — File, Element, Sub-Element	Yes
0x0F	0xAB	SLC-500 Protected Typed Logical Write w/ 4 Address Fields — File, Element, Sub-Element, Bit Mask	No
0x0F	0x95	Encapsulate Other Protocol message	Yes

Related Documentation

For more information on PCCC messages, refer to the *DF1 Protocol and Command Set Reference Manual*, publication 1770-6.5.16.

N-File Addresses

Appendix Objectives

Appendix E provides information on the N-File addresses used when accessing the PCCC object. When using messages, you can use the N-file addresses to locate information about the adapter or SCANport product.

N-File Addresses

The 1203-GK5 and 1336-GM5 support the N-file addresses shown below:

Address	N-File Addresses
N10:0	Number of SCANport product parameters
N10:1 – 999	SCANport product parameters 1 – 999 (value only)
N11:0 – 999	SCANport product parameters 1000 – 1999 (value only)
N12:0 – 999	SCANport product parameters 2000 – 2999 (value only)
N13:0	Number of SCANport adapter parameters
N13:1 – 999	SCANport adapter parameters 1 – 999 (value only)
N30:1 – 999	SCANport product parameters 1 – 999 (all information — read only)
N31:1 – 999	SCANport product parameters 1000 – 1999 (all information — read only)
N32:1 – 999	SCANport product parameters 2000 – 2999 (all information — read only)
N33:1 – 999	SCANport adapter parameters 1 – 999 (all information — read only)
N40:0 – 63	Block Transfer Emulation file
N42:5	1203-GK5 Firmware Emulation Version — The firmware version of the 1203-GK5 this adapter emulates for DriveTools compatibility.
N42:6	Max Network Node — The maximum DeviceNet Node Number
N42:7	Adapter Port # — The SCANport adapter port number the adapter is connected to on the SCANport product
N42:8	Reserved for future use — Always zero

Address	N-File Addresses
N50:0	Number of SCANport product parameters
N50:1 – 249	SCANport product parameters 1 – 249 (value only)
N51:0 – 249	SCANport product parameters 250 – 499 (value only)
.	
.	
.	
N61:0 – 249	SCANport product parameters 2750 – 2999 (value only)
N90:1 – 249	SCANport product parameters 1 – 249 (value only)
N91:0 – 249	SCANport product parameters 250 – 499 (value only)
.	
.	
.	
N101:0 – 249	SCANport product parameters 2750 – 2999 (value only)

Supported Emulated Block Transfer Commands

Appendix Objectives

Appendix F provides information about the Emulated Block Transfer commands supported by the DeviceNet adapter. In this appendix, you will learn about the following:

- Emulated block transfer commands.
- Emulated block transfer error response.
- Setting up data files for listed emulated block transfer commands.
- Examples of emulated block transfer command.

About Emulated Block Transfer

Emulated block transfer is a method used by some SCANport peripherals to read and write information using PCCC messages. Some Allen-Bradley DeviceNet products can send PCCC messages. Other products can send PCCC messages using a DF-1 connection. This appendix assumes that you have experience using emulated block transfer commands with SCANport peripherals.



ATTENTION: Hazard of equipment damage exists. If explicit messages are programmed to frequently write parameter data to certain drive products, the EEPROM (Non-Volatile Storage) will quickly exceed its life cycle and cause the product to malfunction. Do not create a program that frequently uses explicit messages to write parameter data to a product. Datalinks do not write to the EEPROM and should be used for frequently changed parameters.

Supported Emulated Block Transfer Commands

The following table lists some supported emulated block transfer commands and where you can find more information on them.

Command	Page	Command	Page
Parameter Value Read ^①	F-3	NVS Functions	F-14
Parameter Value Write ^①	F-4	Fault Command Write ^①	F-15
Parameter Read Full ^①	F-5	Fault Queue Entry Read Full ^①	F-16
Product ID Number Read ^①	F-8	Fault Queue Size ^①	F-18
Scattered Parameter Read Value	F-10	Trip Fault Queue Number ^①	F-19
Scattered Parameter Write Value	F-12		

^① This function can be accessed in the module and product. The following examples describe how to access it in the product. To do so in the module, add 16384 to the decimal value of header word 2.

Emulated Block Transfer Status Word

When an operation is unsuccessful, header word 2 of the drive response contains a negative value (bit 15 = 1).

If an error occurs, the drive also returns a status word to indicate the reason for the failure. The location of the status word is typically header word 4 in the drive response, but will depend on the message.

Figure F.1
Example Message Structure and Error Message Reply

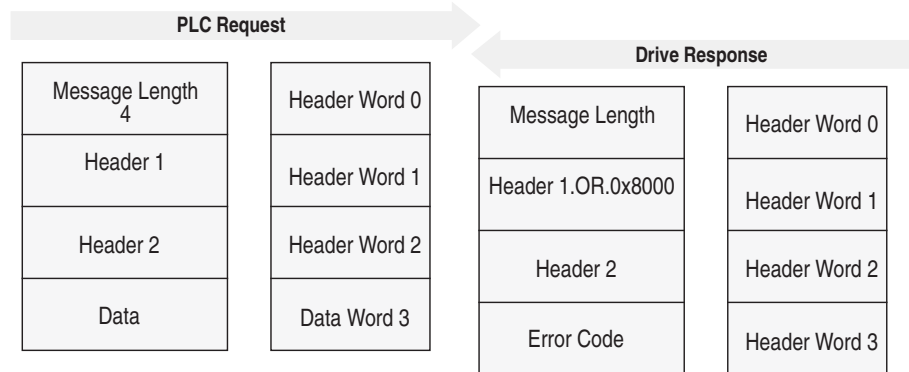

The following table lists the error codes.

Value	Description
0	No error occurred.
1	The service failed due to an internal reason, and the drive could not perform the request.
2	The requested service is not supported.
3	An invalid value in the block transfer emulation request header word 2.
4	An invalid value in the block transfer emulation request header word 3.
5	An invalid value in the block transfer emulation request header word 2.
6	The data value is out of range.
7	There is a drive state conflict. The drive is in an incorrect state to perform the function. The drive cannot be running when you perform certain functions.

Parameter Value Read

Parameter Value Read reads the 16-bit parameter data value for the selected parameter number.

PLC Block Transfer Emulation Instruction Data

PLC request instruction length: 3 words

Drive response instruction length: 1 word

Figure F.2
Message Structure

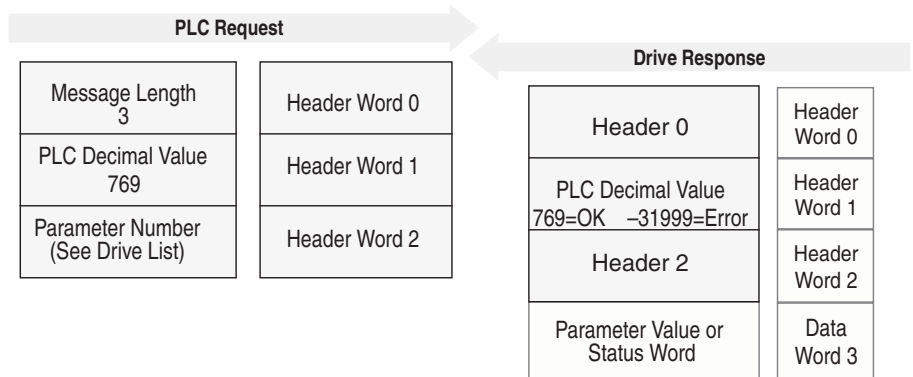

Message Operation

Parameter Value Read reads parameter values from the drive and places that value (or an error code) in word 3 of the drive response data file. The value is shown in device units. Device units are listed in the user manual for the device you are using.

If an error occurs:

- Word 3 of the response contains the status code.
- The status area of the data file is non-zero.

Example

In this example, the value of parameter 20 was requested from a 1336 PLUS drive and a value of 4096 was returned. 4096 is the internal drive unit value for *Maximum Rated Voltage*. This corresponds to a value of 100% Drive Rated Volts in Display Units.

Data File Format

	0	1	2	3	4	5	6	7	8	9
PLC request	3	769	20*							
Drive response	6	769	20*	4069*						

* Example only — These values vary depending on parameters and products.

Parameter Value Write

Parameter Value Write writes a 16-bit parameter data value to the selected parameter number.

PLC Block Transfer Emulation Instruction Data

PLC request instruction length: 1 word

Drive response instruction length: 4 words

Figure F.3
Message Structure

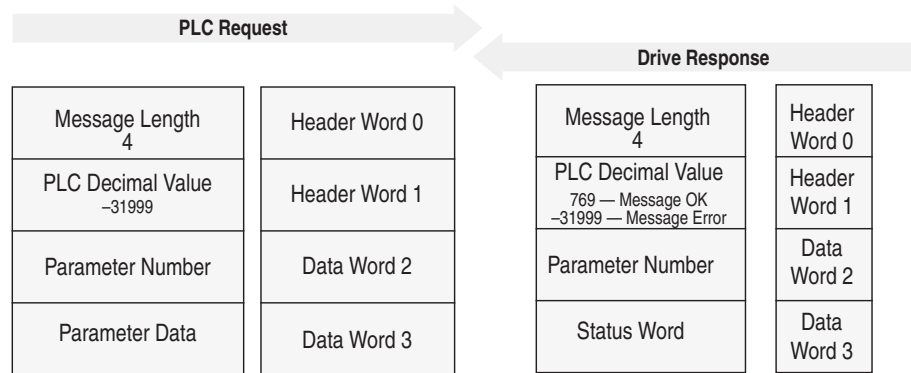

Message Operation

Parameter Value Write sends a new value to the specified parameter. The value must be in device units. Units for each parameter are listed in the device manual.

If an error has occurred, word 1 of the response returns a value of -31999, and word 3 contains a status code.

Example

In this example, a value of 4096 was sent to Parameter 20. 4096 is in drive units and indicates a value of 100% Drive Rated Volts, as defined in P147, *Drive Rated Volts*.

Data File Format

	0	1	2	3	4	5	6	7	8	9
PLC request	4	-31999	20*	4096*						
Drive response	3	769	20*							

* Example only — These values vary depending on parameters and products.

Parameter Read Full

Parameter Read Full provides all known attributes for the parameters requested. This information includes the parameter's current value, descriptor, multiply and divide value, base value, offset value, text string, group element reference, minimum value, maximum value, default value, and unit text string.

PLC Block Transfer Emulation Instruction Data

PLC request instruction length: 3 words

Drive response instruction length: 20 words

Figure F.4
Message Structure

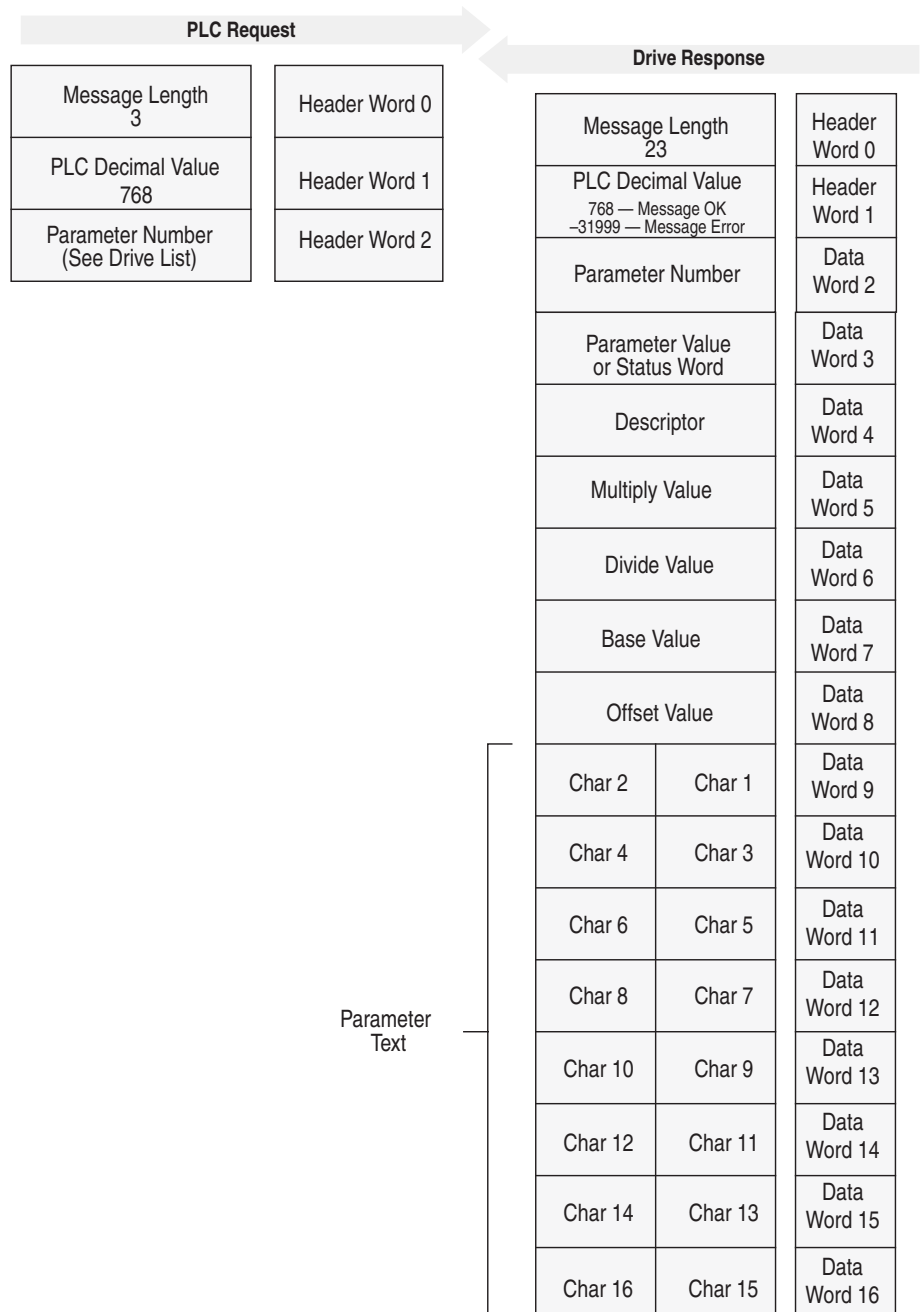
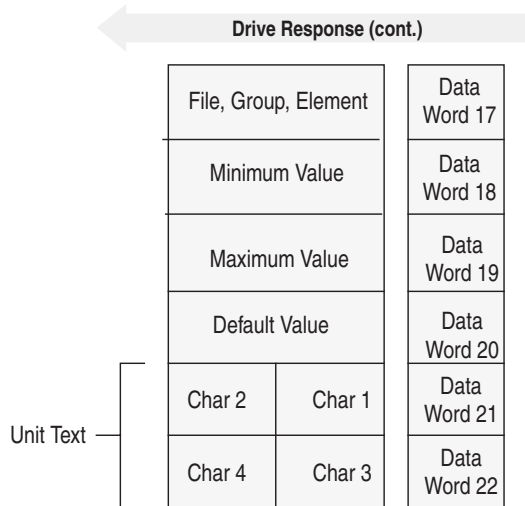

Figure F.4
Message Structure (Continued)



Message Operation

Parameter Read Full retrieves the attributes of the specified parameter. The attributes for each parameter include the data, minimum and maximum values, and the parameter text. The response message returns this information.

If an error has occurred in reading any of the values, word 3 contains the status word.

The parameter text is returned with each data word containing two ASCII characters per word. The first and second characters are in opposite order.

Example

In this example, a **Parameter Read Full** was performed through block transfer on a 1336 PLUS drive. N10:10 shows the header message for the request. The data is returned in the response data file, starting with word 3, for parameter 20. Word 3 shows the present value in drive units. Word 4 through word 8 provide scaling information, used to convert drive units to engineering units for the Human Interface Module (HIM). Word 9 through word 16 provide the parameter name.

This example shows the response message in both binary and ASCII. Note the ASCII information beginning with word 9. The parameter name characters return in reverse order for each word. Word 9 has the ASCII value of (aM). To read this, reverse the word to read (Ma). The next word (ix), reversed, gives you (xi). These words, along with the following two words, form the word *Maximum*. You can see the parameter name *Maximum Voltage* in word 9 through word 16 of the response message. In addition, words 21 – 22 are also returned in this format. These words provide the units in which the parameter is defined. In this example it is *vlt*s.

Word 17 contains the file, group, and element which are used to reference the parameter.

Words 18 – 20 contain the minimum, maximum, and default values of this parameter.

Data File Format

	0	1	2	3	4	5	6	7	8	9
PLC request	3	768	20*							
Drive response	23	768	20*	4096*	355*	1*	4096*	460*	0*	24909*
(Decimal)	27000*	30061*	8301*	28502*	29804*	26465*	8293*	1794*	1024*	4915*
	4096*	27734*	29556*							
Drive response	\00\17	\03\00	\00\14	\10\00	\01 c	\00\01	\10\00	\01\CC	\00\00	a M
(ASCII)	i x	u m	m	o V	t l	g a	e	07 02	04 00	\13 0
	\10\00	l V	s t							

* Example only — These values vary depending on parameters and products.

Product ID Number Read

Product ID Number Read returns the product ID of the device to which the DeviceNet adapter is connected.

PLC Block Transfer Emulation Instruction Data

PLC request instruction length: 3 words

Drive response instruction length: 4 words

Figure F.5
Message Structure

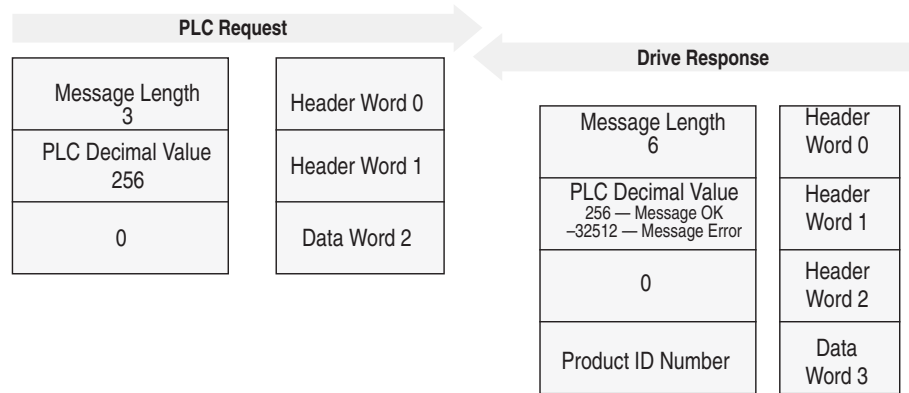

Product Code (Hex)	Product Code (Decimal)	Bulletin Number	Product
0x02	2	1336S	1336 PLUS 0.5 – 10 HP
0x03	3	1336S	1336 PLUS 7.5 – 800 HP
0x07	7	1336F	1336 PLUS II
0x10	16	1336T	1336 FORCE w/PLC Adapter Board
0x11	17	2364F	2364 RGU DC Bus Regen Front End
0x12	18	1394	1394 Motion Drive
0x13	19	1557	1557 Medium Voltage AC Drive
0x14	20	193	SMP-3
0x15	21	150	SMC Dialog Plus
0x17	23	1305	1305 AC Drive
0x18	24	1397	1397 DC Drive
0x19	25	1336R	1336 Line Regeneration Package
0x20	32	1336T	1336 FORCE w/Standard Adapter Board
0x22	34	1336E	1336 IMPACT

Message Operation

Product ID Number Read, through the drive response message word 3, indicates the type of device the DeviceNet adapter is connected to. This value is defined in the message response chart shown above.

If an error has occurred, word 1 of the response returns a negative value of -32512 .

Example

In this example, the **Product ID Number Read** was requested. The drive response contained a value of 3 in word 3 of its message response, indicating a connection to a 1336 PLUS drive.

Data File Format

	0	1	2	3	4	5	6	7	8	9
PLC request	3	256	0							
Drive Response	6	256	0	3*						

* Example only — These values vary depending on parameters and products.

Scattered Parameter Value Read

Scattered Parameter Value Read reads a scattered list of parameters.

PLC Block Transfer Emulation Instruction Data

PLC request instruction length: 5 – 63 words

Drive response instruction length: 5 – 63 words

Figure F.6
Message Structure

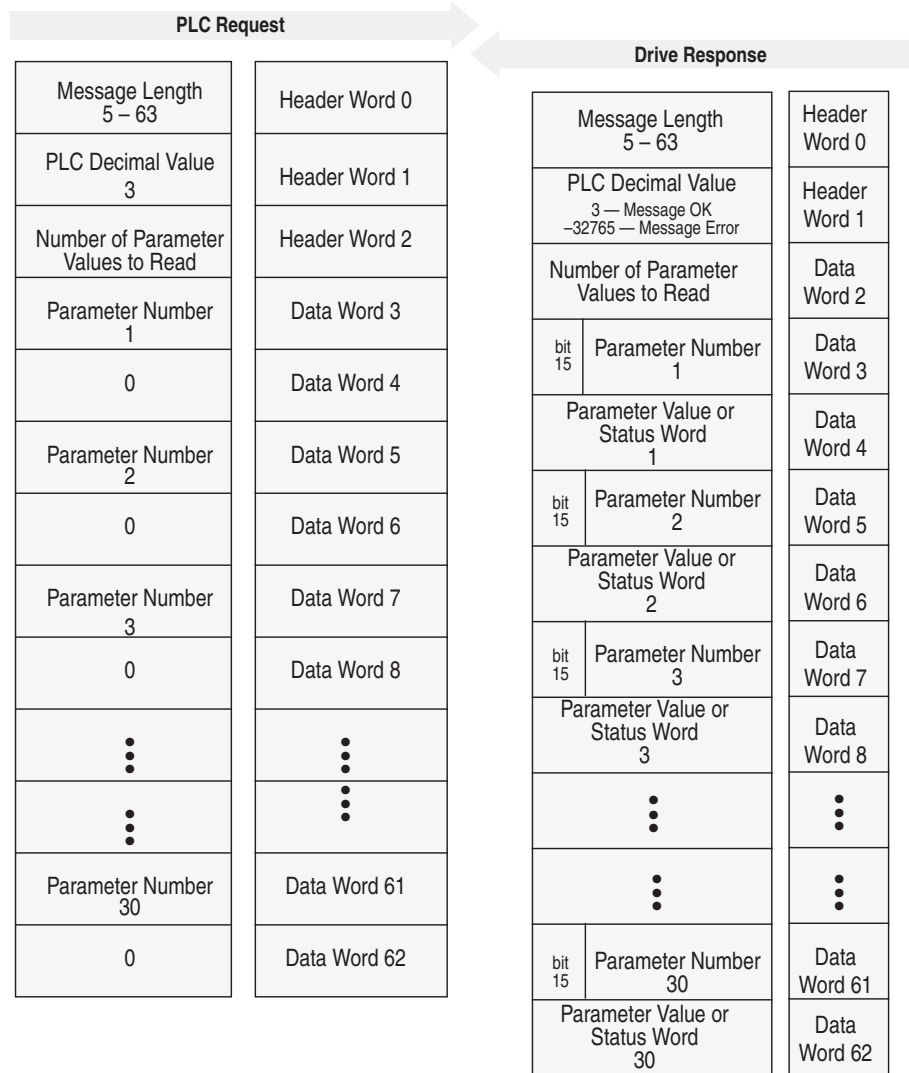

Message Operation

Scattered Parameter Value Read reads a pre-defined group of parameter values, in any order, from the device. You define the number of parameters to read in word 2 of the request. The parameters to be read and their order is defined starting with word 3. An unused word is left between each parameter request, so the drive can respond with the parameter value, as shown.

If an error has occurred in reading any of the parameters:

- Word 1 of the drive response returns a value of -32765 .
- Bit 15 of the drive response word for the number of that parameter is set.
- The drive response word for the value of that parameter returns a status word instead of returning the parameter value.

Example

In this example, eight parameters were read from a 1336 PLUS drive, as defined in word 2 of the request. Parameter numbers 5, 7, 8, 20, 18, 17, 19, and 36 were requested. The drive response returned the values of these parameters in the data file. These values are in drive units.

Data File Format

	0	1	2	3	4	5	6	7	8	9
PLC request	19	3	8*	5*	0	7*	0	8*	0	20*
	0	18*	0*	17*	0	19*	0	36*	0	
Drive response	19	3	8*	5*	6*	7*	1000*	8*	1000*	20*
	4096*	18*	4096*	17*	51*	19*	60*	36*	6144*	

* Example only — These values vary depending on parameters and products.

Scattered Parameter Value Write

Scattered Parameter Value Write writes to a scattered list of parameters and returns the status of each parameter. If any of the states have errors, the parameter number is negative.

PLC Block Transfer Emulation Instruction Data

PLC request instruction length: 5 – 63 words

Drive response instruction length: 5 – 63 words

Figure F.7
Message Structure

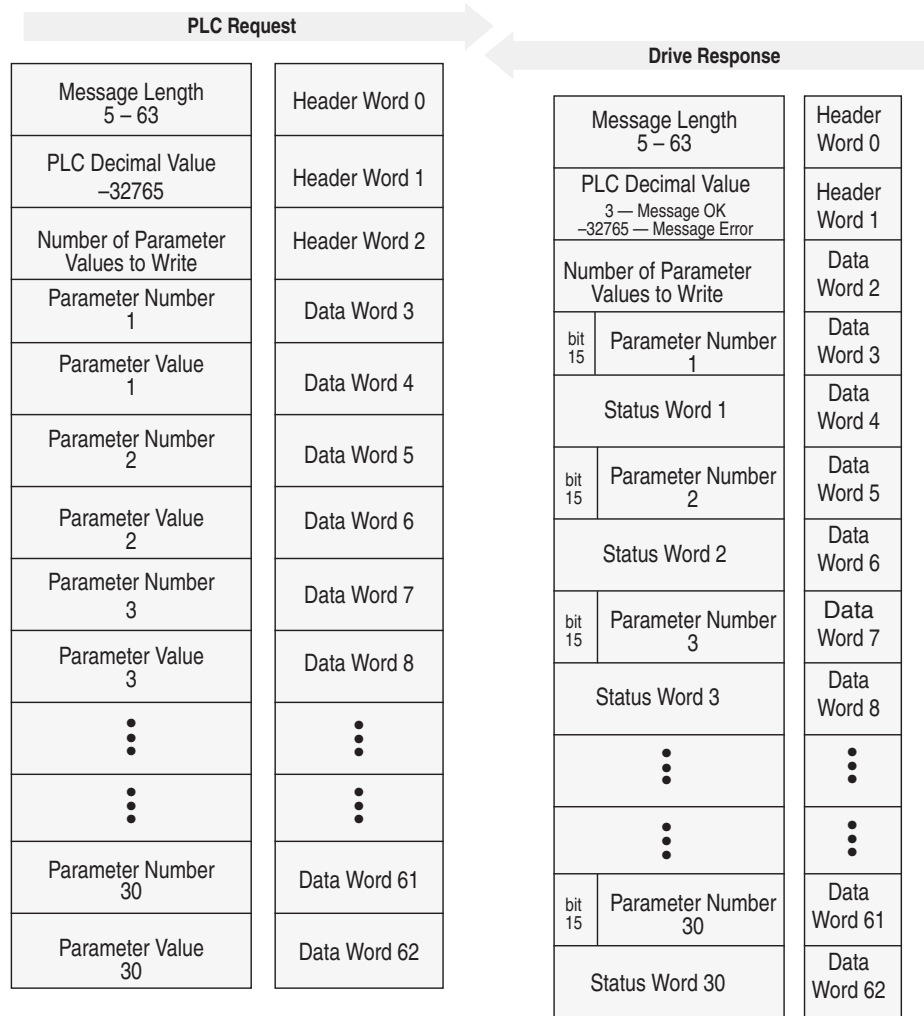

Message Operation

Scattered Parameter Value Write writes data values to a pre-defined group of device parameters in any order. You define the number of parameters to write in word 2. The parameters to be written to and their order is defined starting with word 3.

If an error occurs while writing to any of the parameters:

- Word 1 of the drive response returns a value of -32765 .
- Bit 15 of the drive response word for that parameter's number is set.
- The drive response word for that parameter's status word is non-zero.

If no error has occurred:

- Word 1 of the drive response returns a value of 3.
- Each of the drive response's parameter numbers are the same as in the request.
- Each of the drive response status words returns a value of 0.

Example

In this example, six parameters were written to in a 1336 PLUS drive. Word 2 of the request defines the number of parameter values that are transferred. Beginning with word 3, the message lists each parameter number followed by the value of the parameter. The values are entered in device units.

The drive response returns the status of each parameter write. If the request was successful, a zero is returned. If an error has occurred, the response returns a status word code for the error.

Data File Format

	0	1	2	3	4	5	6	7	8	9
PLC request	15	-32765	6*	90*	1*	150*	4*	30*	20*	31*
	10*	10*	2*	12*	5*					
Drive response	15	3	6*	90*	0*	150*	0*	30*	0*	31*
	0*	10*	0*	12*	0*					

* Example only — These values vary depending on parameters and products.

NVS Functions

NVS (Non-Volatile Storage) Functions activates the specified NVS functions.

PLC Block Transfer Emulation Instruction Data

PLC request instruction length: 4 words

Drive response instruction length: 3 words

Figure F.8
Message Structure

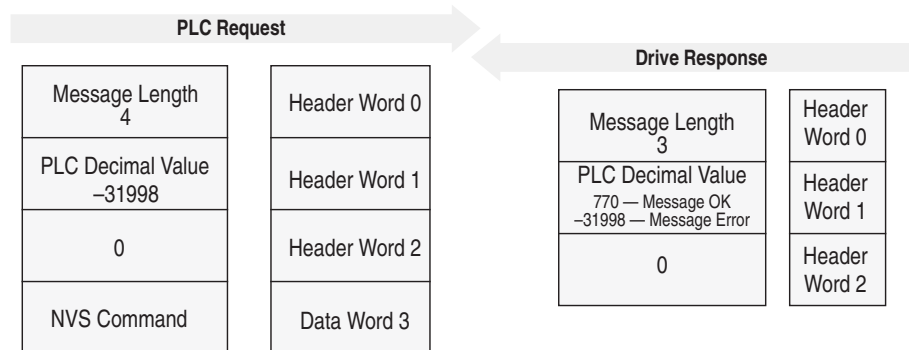

Value	NVS Command
00	Not Used
01	NVS Save
02	NVS Recall
03	NVS Default Initialize

Message Operation

The NVS storage function allows three different message requests:

- NVS Save saves parameter information from the working memory or RAM to NVS Storage.
- NVS Recall retrieves the last saved data from NVS Storage and places it in the working memory or RAM.
- NVS Default Initialize clears the RAM and NVS Storage and sets all parameter values to default.

If an error has occurred, response word 1 returns a value of -31998.

Example

This example requests the NVS Storage Save function be performed.

Data File Format

	0	1	2	3	4	5	6	7	8	9
PLC request	4	-31998	0*	0, 1, 2, or 3						
Drive response	3	770	0*							

* Example only — These values vary depending on parameters and products.

Fault Command Write

Fault Command Write activates the Clear Fault, Clear Fault Queue, and Drive Reset functions.

PLC Block Transfer Emulation Instruction Data

PLC request instruction length: 4 words

Drive response instruction length: 4 words

Figure F.9
Message Structure

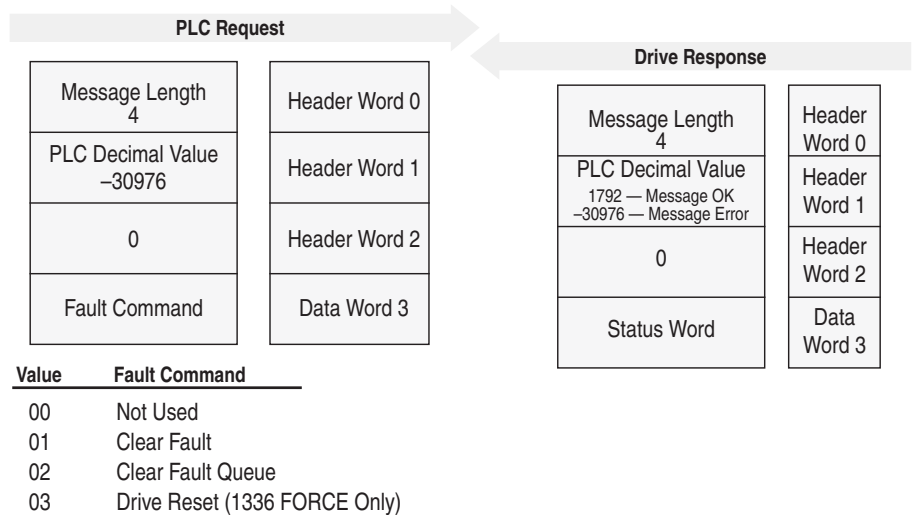

Message Operation

The specified fault Clear/Reset function sends a fault handling request to the device.

- A Clear Fault request clears the last fault that occurred.
- A Clear Fault Queue clears the entire fault buffer. Certain devices may store more than one fault.
- A Drive Reset is used with the 1336 FORCE drive product only. This function resets the drive; it clears the fault queue and writes the parameter information stored in NVS Storage to RAM.

Data File Format

	0	1	2	3	4	5	6	7	8	9
PLC request	4	-30976	0	0, 1, 2, or 3						
Drive response	4	1792	0	0*						

* Example only — These values vary depending on parameters and products.

Fault Queue Entry Read Full

Fault Queue Entry Read Full reads the contents of the specified fault queue entry. A message is returned which includes the fault text and fault code associated with the specified fault queue entry. The 1336 FORCE drive also returns the time stamp associated with the fault.

PLC Block Transfer Emulation Instruction Data

PLC request instruction length: 3 words

Drive response instruction length: 12 or 16 words

Figure F.10
Message Structure

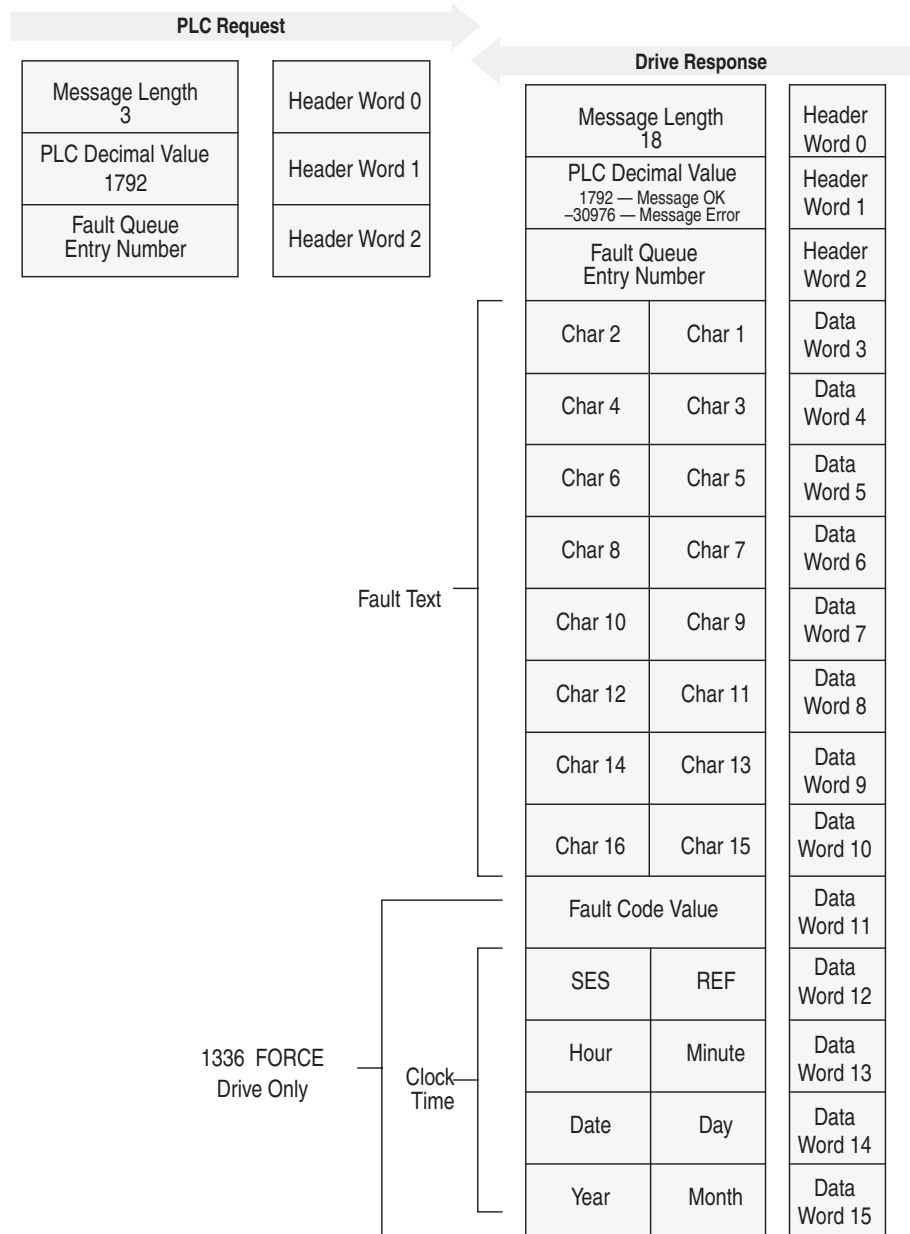

Message Operation

Fault Queue Entry Read Full reads the contents of the fault queue specified in word 3 of the request. The response returns the fault text which can be ASCII text. Every two characters of text are in reverse order. Also, the 1336 FORCE drive returns a time stamp, indicating the day and time the fault occurred.

If an error has occurred, word 1 of the response returns a negative value.

Example

In this example, Fault Queue Entry number 3 was retrieved from a 1336 PLUS drive. The drive response returned the ASCII text *Drive Reset Flt*, with each character reversed. The fault code for this example is 22.

Data File Format

	0	1	2	3	4	5	6	7	8	9
PLC request	3	1792	3*							
Drive response	18	1792	3*	29252*	20313*	8293*	25938*	25971*	8308*	27718*
	8303*	22*								
Drive response	\00\12	\07\00	\03\00	rD	vi	e	eR	es	t	IF
	t	\00\16								

* Example only — These values vary depending on parameters and products.

Fault Queue Size

Fault Queue Size gets the number of fault entries allowed in the fault queue.

PLC Block Transfer Emulation Instruction Data

PLC request instruction length: 3 words

Drive response instruction length: 4 words

Figure F.11
Message Structure

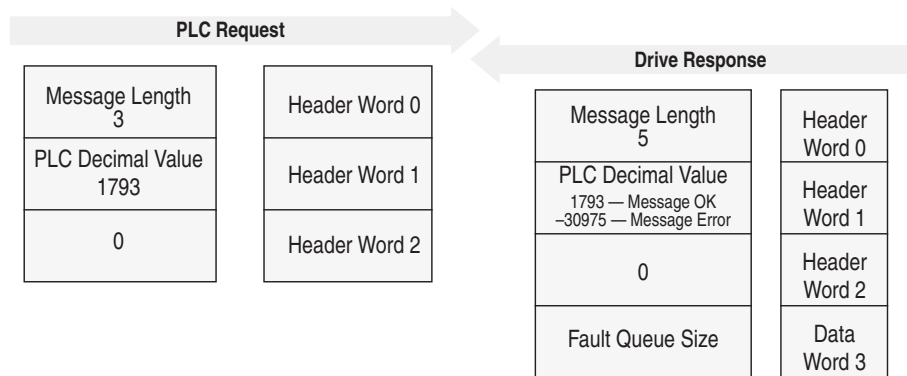

Message Operation

Fault Queue Size reads back the size of the fault queue available in the product. Each product may have a different number of fault queue entries available for storage.

If an error has occurred, word 1 of the response returns a value of -30975.

Example

In this example, a 1336 PLUS drive was used. This product has a fault queue of four storage locations available to store faults. This value is seen in word 3 of the response header message.

Data File Format

	0	1	2	3	4	5	6	7	8	9
PLC request	3	1793	0							
Drive response	6	1793	0	4*						

* Example only — These values vary depending on parameters and products.

Trip Fault Queue Number

Trip Fault Queue Number provides the fault queue number of the fault that caused the device to trip.

PLC Block Transfer Emulation Instruction Data

PLC request instruction length: 3 words

Drive response instruction length: 4 words

Figure F.12
Message Structure

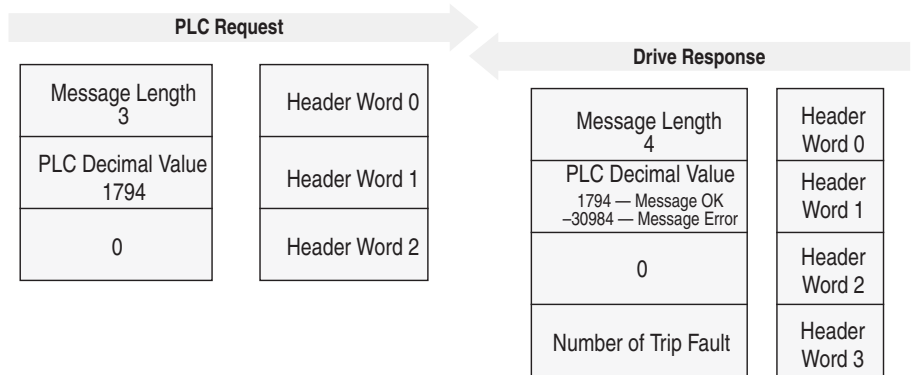

Message Operation

Trip Fault Queue Number provides the number of the entry in the fault queue that tripped the device in word 3 of the drive response. The fault queue number is 0 when the device is not faulted.

If an error has occurred in the block transfer, word 1 of the response is negative.

Example

In this example, the device has stored a fault in the first entry of the fault queue that caused the drive to trip. Word 3 of the response indicates the entry number.

Data File Format

	0	1	2	3	4	5	6	7	8	9
PLC request	3	1794	0							
Drive response	6	1794	0	1*						

* Example only — These values vary depending on parameters and products.

This Page Intentionally Left Blank.

Numerics

- 1203-GK5 module
 - configuring to communicate with a PLC scanner, 4-8 to 4-12
 - configuring to communicate with an SLC scanner, 4-13 to 4-18
 - configuring with dip switches, 2-2
 - creating an EDS file for, 4-4 to 4-7
 - default settings, 2-1, B-1
 - features, 1-2
 - function, 1-1
 - hardware, 1-4
 - illustration, 1-4
 - installation, 3-3 to 3-5
 - LEDs, 7-1 to 7-4
 - removal, 3-6
 - setting up, 1-5
 - specifications, A-1
 - switches, 2-1
 - troubleshooting, 7-1
- 1336-GM5 board
 - configuring to communicate with a PLC scanner, 4-8 to 4-12
 - configuring to communicate with an SLC scanner, 4-13 to 4-18
 - configuring with dip switches, 2-2
 - creating and EDS file for, 4-4 to 4-7
 - default settings, 2-1, B-1
 - features, 1-2
 - function, 1-1
 - hardware, 1-5
 - illustration, 1-5
 - installation, 3-7 to 3-9
 - LEDs, 7-1 to 7-4
 - removal, 3-10
 - setting up, 1-5
 - specifications, A-2
 - switches, 2-1
 - troubleshooting, 7-1

A

- adapter, refer to 1203-GK5 module or 1336-GM5 board

B

- block transfer emulation, refer to emulated block transfer commands

C

- cables
 - DeviceNet
 - connecting, 3-9
 - connecting to connector, 3-4
 - connecting to module, 3-5

- disconnecting, 3-6, 3-10
- selecting, 3-2

- SCANport
 - connecting to module, 3-5
 - disconnecting, 3-6
 - selecting, 3-1

- communications module, refer to 1203-GK5 module or 1336-GM5 board
- configuring the 1203-GK5 module or 1336-GM5 board, 2-2

D

- data rate, 2-5
- datalinks
 - default I/O size, 4-6
 - I/O size, 4-11, 4-16
 - setting, 2-6
- default settings for adapter, 2-1
- DeviceNet
 - cable, 3-2
 - definition, P-3
 - overview, 1-1
- DeviceNet adapter, refer to 1203-GK5 module or 1336-GM5 board
- DeviceNet Manager
 - about, 4-1
 - creating an EDS file, 4-4 to 4-7
 - online mode, 4-2 to 4-3
- DeviceNet objects, C-1 to C-26
 - connection, C-6
 - DeviceNet, C-5
 - identify, C-2
 - message router, C-4
 - parameter, C-10
 - PCCC, C-18
 - register, C-8
 - SCANport pass-through fault queue, C-21
 - SCANport pass-through link, C-25
 - SCANport pass-through parameter, C-20
 - SCANport pass-through warning queue, C-23

- DIN rail
 - attaching modules, 3-3
 - specification, A-1
- dip switches, 2-1

E

- editing parameters, 4-20 to 4-21
- EDS file, 4-4
- electronic data sheets, 4-4
- electrostatic discharge precautions, 3-7
- emulated block transfer commands
 - fault command write, F-15
 - fault queue entry read full, F-16
 - fault queue size, F-18

- NVS functions, F-14
- parameter read full, F-5
- parameter value read, F-3
- parameter value write, F-4
- product ID number read, F-8
- scattered parameter value read, F-10
- scattered parameter value write, F-12
- trip fault queue number, F-19
- equipment required, 1-6
 - configuring a scanner, 4-1
 - installation
 - 1203-GK5 module, 3-3
 - 1336-GM5 board, 3-7
 - ladder logic programming, 5-1

F

- fault configurable settings, 2-7

I

- installation
 - 1203-GK5 module, 3-3 to 3-5
 - 1336-GM5 board, 3-7 to 3-9

L

- ladder logic programs
 - description, 5-2
 - example, 5-2 to 5-8

LEDs

- DeviceNet, 7-2
- location, 7-1
- SCANport, 7-3

M

- manual
 - audience, P-1
 - contents, P-2
 - conventions, P-4
 - purpose, P-1
- messaging
 - controlling devices with, 6-11
 - description, 6-1
 - emulated block transfer, F-1 to F-19
 - examples, 6-6 to 6-10
 - explicit
 - 1747-SDN scanner, 6-4
 - 1771-SDN scanner, 6-2
 - N-file structure, E-1
 - PCCC, D-1
 - writing to register object, 6-12
- module, refer to 1203-GK5 module or 1336-GM5 board

N

- N-file structure, E-1
- node address, 2-4

O

- objects, refer to DeviceNet objects
- online mode in DeviceNet Manager, 4-2 to 4-3

P

- parameters
 - editing with DeviceNet Manager, 4-20 to 4-21
 - editing with emulated block transfer commands, F-3 to F-13

PCCC

- messaging, D-1

PLC

- configuring to communicate with the adapter, 4-8 to 4-12
- ladder logic programs, 5-4

R

- removal
 - 1203-GK5 module, 3-6
 - 1336-GM5 board, 3-10
- RSLogix, 5-1

S

- safety precautions, P-3, 2-3
- SCANport
 - cables, 3-1
 - definition, P-3
 - list of products, 1-3
 - peripheral, 1-3
 - peripherals, P-3
 - products, P-3
- SLC
 - configuring to communicate with the adapter, 4-13 to 4-18
 - ladder logic programs, 5-6
- specifications, A-1
- switches, 2-1

T

- technical support, P-4
- terms and abbreviations, P-3
- troubleshooting, 7-1



We Want Our Manuals to be the Best!

You can help! Our manuals must meet the needs of you, the user. This is your opportunity to make sure they do just that. By filling out this form you can help us provide the most useful, thorough, and accurate manuals available. Please take a few minutes to tell us what you think - then mail this form or FAX it.

FAX: your local Allen-Bradley Sales Office or 414/512-8579

PUBLICATION NAME _____

PUBLICATION NUMBER, DATE AND PART NUMBER (IF PRESENT) _____

✓ CHECK THE FUNCTION THAT MOST CLEARLY DESCRIBES YOUR JOB.

- SUGGEST/RESPONSIBLE FOR THE PURCHASE OF EQUIPMENT
- DESIGN/IMPLEMENT ELECTRICAL SYSTEMS
- SUPERVISE FLOOR OPERATIONS
- MAINTAIN/OPERATE PROGRAMMABLE MACHINERY
- TRAIN/EDUCATE MACHINE USERS

✓ WHAT LEVEL OF EXPERIENCE DO YOU HAVE WITH EACH OF THE FOLLOWING PRODUCTS?

	NONE	LITTLE	MODERATE	EXTENSIVE
PROGRAMMABLE CONTROL	<input type="checkbox"/>	<input type="checkbox"/>	<input type="checkbox"/>	<input type="checkbox"/>
AC/DC DRIVES	<input type="checkbox"/>	<input type="checkbox"/>	<input type="checkbox"/>	<input type="checkbox"/>
PERSONAL COMPUTERS	<input type="checkbox"/>	<input type="checkbox"/>	<input type="checkbox"/>	<input type="checkbox"/>
NC/CNC CONTROLS	<input type="checkbox"/>	<input type="checkbox"/>	<input type="checkbox"/>	<input type="checkbox"/>
DATA COMMUNICATIONS/LAN	<input type="checkbox"/>	<input type="checkbox"/>	<input type="checkbox"/>	<input type="checkbox"/>

✓ RATE THE OVERALL QUALITY OF THIS MANUAL BY CIRCLING YOUR RESPONSE BELOW. (1) = POOR (5) = EXCELLENT

HELPFULNESS OF INDEX/TABLE OF CONTENTS	1	2	3	4	5
CLARITY	1	2	3	4	5
EASE OF USE	1	2	3	4	5
ACCURACY AND COMPLETENESS	1	2	3	4	5
QUALITY COMPARED TO OTHER COMPANIES' MANUALS	1	2	3	4	5
QUALITY COMPARED TO OTHER ALLEN-BRADLEY MANUALS	1	2	3	4	5

✓ WHAT DID YOU LIKE MOST ABOUT THIS MANUAL?

✓ WHAT DID YOU LIKE LEAST ABOUT THIS MANUAL?

✓ PLEASE LIST ANY ERRORS YOU FOUND IN THIS MANUAL (REFERENCE PAGE, TABLE, OR FIGURE NUMBERS).

✓ DO YOU HAVE ANY ADDITIONAL COMMENTS?

✓ COMPLETE THE FOLLOWING.

NAME _____ COMPANY _____

TITLE _____ DEPARTMENT _____

STREET _____ CITY _____ STATE _____ ZIP _____

TELEPHONE _____ DATE _____

CUT ALONG DOTTED LINE 

FOLD HERE

FOLD HERE



BUSINESS REPLY MAIL
FIRST CLASS PERMIT NO. 413 MEQUON, WI

POSTAGE WILL BE PAID BY ADDRESSEE

ALLEN-BRADLEY

Attn: Marketing Communications
P.O. Box 760
Mequon, WI 53092-9907

NO POSTAGE
NECESSARY
IF MAILED
IN THE
UNITED STATES

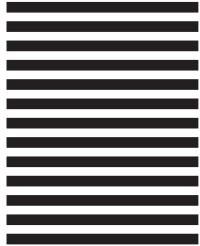

1336 FORCE, 1336 IMPACT, Data Highway Plus, and SCANport are trademarks of Rockwell Automation.

PLC, PLC-5, SLC and SLC-5/03 are registered trademarks of Rockwell Automation.

ControlNet is a trademark of ControlNet International, Ltd.

DeviceNet Manager, RSLinx, RSLogix5, and RSLogix500 are trademarks of Rockwell Software.

DeviceNet is a trademark of the Open DeviceNet Vendor Association.

Windows and Microsoft are either registered trademarks or trademarks of Microsoft Corporation.

www.rockwellautomation.com

Power, Control and Information Solutions Headquarters

Americas: Rockwell Automation, 1201 South Second Street, Milwaukee, WI 53204-2496 USA, Tel: (1) 414.382.2000, Fax: (1) 414.382.4444

Europe/Middle East/Africa: Rockwell Automation, Vorstaan/Boulevard du Souverain 36, 1170 Brussels, Belgium, Tel: (32) 2 663 0600, Fax: (32) 2 663 0640

Asia Pacific: Rockwell Automation, Level 14, Core F, Cyberport 3, 100 Cyberport Road, Hong Kong, Tel: (852) 2887 4788, Fax: (852) 2508 1846